

# Handheld Thermal Temperature Monitoring Camera

## Quick Start Guide







# Foreword

## General

This manual introduces the appearance and basic operations of the thermal temperature-monitoring camera (hereinafter referred to as "the Camera").

## Safety Instructions

The following categorized signal words with defined meaning might appear in the manual.

Signal Words	Meaning
 <b>DANGER</b>	Indicates a high potential hazard that, if not avoided, will result in death or serious injury.
 <b>WARNING</b>	Indicates a medium or low potential hazard that, if not avoided, could result in slight or moderate injury.
 <b>CAUTION</b>	Indicates a potential risk that, if not avoided, could result in property damage, data loss, lower performance, or unpredictable result.
 <b>TIPS</b>	Provides methods to help you solve a problem or save you time.
 <b>NOTE</b>	Provides additional information as the emphasis and supplement to the text.

## Revision History

Version	Revision Content	Release Time
V1.0.0	First release.	June 2020

## About the Manual

- The manual is for reference only. If there is inconsistency between the manual and the actual product, the actual product shall prevail.
- We are not liable for any loss caused by the operations that do not comply with the manual.
- The manual would be updated according to the latest laws and regulations of related jurisdictions. For detailed information, refer to the paper manual, CD-ROM, QR code or our official website. If there is inconsistency between paper manual and the electronic version, the electronic version shall prevail.
- All the designs and software are subject to change without prior written notice. The product updates might cause some differences between the actual product and the manual. Please contact the customer service for the latest program and supplementary documentation.
- There still might be deviation in technical data, functions and operations description, or errors in print. If there is any doubt or dispute, we reserve the right of final explanation.
- Upgrade the reader software or try other mainstream reader software if the manual (in PDF format) cannot be opened.
- All trademarks, registered trademarks and the company names in the manual are the properties of their respective owners.
- Please visit our website, contact the supplier or customer service if there is any problem occurring when using the device.
- If there is any uncertainty or controversy, we reserve the right of final explanation.

# Important Safeguards and Warnings

This chapter describes the contents covering proper handling of the Camera, hazard prevention, and prevention of property damage. Read these contents carefully before using the Camera, comply with them when using, and keep it well for future reference.

## Power Requirements

- All installation and operation should conform to your local electrical safety code.
- Check whether the power supply is correct before operating the Camera.
- The power source shall conform to the requirement of the Safety Extra Low Voltage (SELV) standard, and supply power with rated voltage which conforms to Limited power Source requirement according to IEC60950-1. Note that the power supply requirement is subject to the Camera label.
- Install easy-to-use devices for power off before installing wiring, which is for emergent power off when necessary.
- Prevent the line cord from being trampled or pressed, especially the plug, power socket and the junction from the Camera.



- Risk of explosion if the battery is replaced by an incorrect type.
- Replacement of a battery with an incorrect type that can defeat a safeguard (for example, in the case of some lithium battery types).
- Disposal of a battery into fire or a hot oven, or mechanically crushing or cutting of a battery can result in an explosion.
- High or low extreme temperatures that a battery can be subjected to during use, storage or transportation; and low air pressure at high altitude.
  - ◇ Leaving a battery in an extremely high temperature surrounding environment that can result in an explosion or the leakage of flammable liquid or gas.
  - ◇ A battery subjected to extremely low air pressure that may result in an explosion or the leakage of flammable liquid or gas.

## Application Environment Requirements

- Use the Camera within the allowed humidity and altitude.
- Do not use the Camera in the strong vibration environment such as in boats and vehicles.



If you still want to use thermal cameras in the two conditions mentioned above, please contact our sales staff to buy cameras of special model or cameras that are customized. If you use cameras in improper environments, we shall not take the costs of camera damage.

- There is a default temperature monitoring range of targets for the Camera. Use the Camera within the range.
- Use the Camera within the required working temperature and humidity.
- Do not place the Camera in the humid, dusty, extremely hot and cold site with strong electromagnetic radiation or unstable illumination.
- Do not block the ventilation of the Camera to avoid heat accumulation.
- Do not install the Camera near the heat source such as radiator, heater, and stove to avoid fire.

- Do not aim the lenses at intense radiation source (such as sun, laser, and molten steel) to avoid damage to thermal detector and visible lens.
- Prevent liquid from flowing into the Camera to avoid damage to the internal components. In case the liquid entering the Camera, immediately stop using the Camera, cut off the power, and disconnect all the cables. Then contact the local customer service center.
- Do not stuff foreign materials into the Camera to prevent short circuit which could cause Camera damage or injury.
- Use the factory default package or material with equal quality to pack the Camera when transporting the Camera.
- Do not press, vibrate or soak the Camera during transportation, storage and installation.

## Operation and Maintenance Requirements

- Do not touch the heat dissipation component of the Camera in case you might get burnt.
- Do not dismantle the Camera; there is no part which can be repaired by users themselves. It may cause water leakage or bad image for the Camera if it is dismantled unprofessionally.
- It is recommended to use the Camera together with a lightning arrester, which is to improve the effect of lightning protection. It needs to conform to the lightning protection regulation for outdoor application.
- Do not touch the photosensitive Camera with your hands. Use an air blower to clean the dust on the lens. For further cleaning, pour a little alcohol into a piece of dry cloth with which you can softly wipe the dirt away.
- Clean Camera body with a piece of soft dry cloth. For any dirt hard to remove, pick up a piece of clean and soft cloth, dip it with a little neutral detergent and gently wipe the dust away—after that, wipe all the liquids on the Camera away with another dry cloth. Never use any volatile solvent such as alcohol, benzene and thinner, or any cleaner that is strong and abrasive. Otherwise, the Camera's surface coating will be hurt and its working performance will be encumbered.

### WARNING

- Use the accessories regulated by the manufacturer. The Camera should be installed and maintained by professionals.
- Contact the local dealer or the nearest service center if the Camera fails to work normally. Do not dismantle or modify the Camera.

# Table of Contents

Foreword .....	I
Important Safeguards and Warnings .....	II
1 Checking the Package .....	1
2 Structure .....	2
2.1 Dimensions .....	2
2.2 Appearance .....	2
3 Basic Operations .....	4
3.1 Live Interface .....	4
3.2 Installing SD Card .....	5
3.3 Capturing Images .....	5
3.4 Recording Videos .....	5
3.5 Viewing Images .....	5
3.6 Viewing Recorded Videos .....	5
3.7 Exporting Images and Recorded Videos .....	6
3.8 Upgrade .....	6
3.9 Auto Maintenance .....	7
4 Temperature Monitoring Configuration .....	8
4.1 Temperature Settings .....	8
4.2 Temperature Monitoring Settings .....	9
5 System Settings .....	10

# 1 Checking the Package

Check the package according to the following checklist. If you find device damage or any loss, contact the after-sales service.

Figure 1-1 Package items

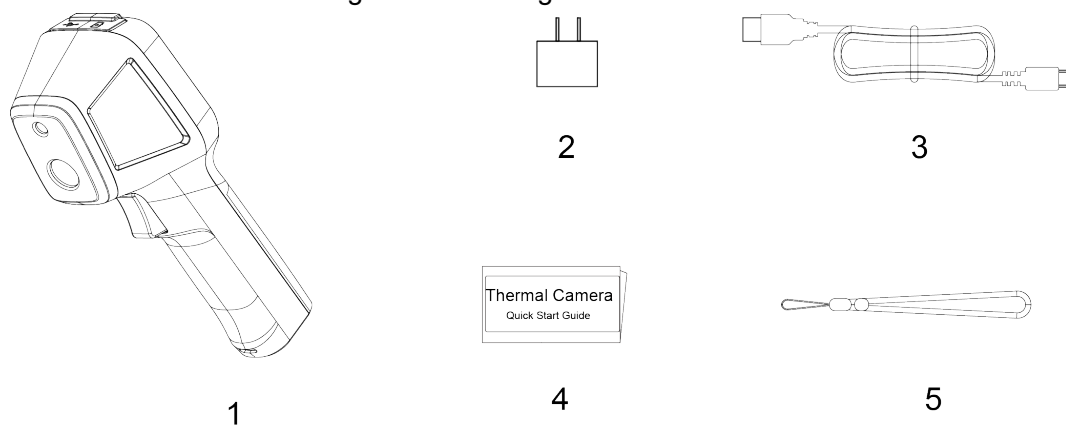

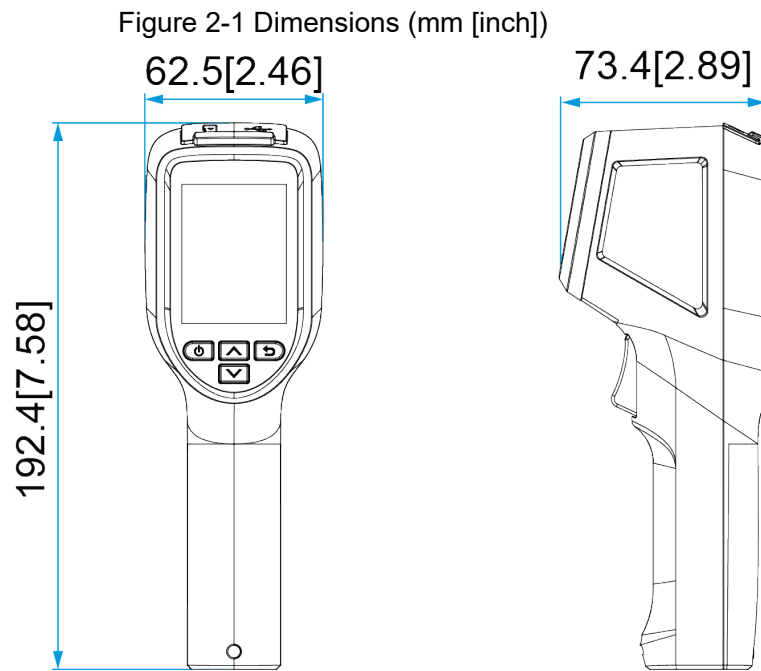

Table 1-1 Package items

No.	Name	No.	Name
1	The Camera	2	Adapter  Five plugs are provided for Chinese, American, European, Australian, and British standards.
3	USB cable	4	Quick start guide
5	Wrist rope	—	—

# 2 Structure

## 2.1 Dimensions



## 2.2 Appearance

Front Panel

Figure 2-2 Front panel

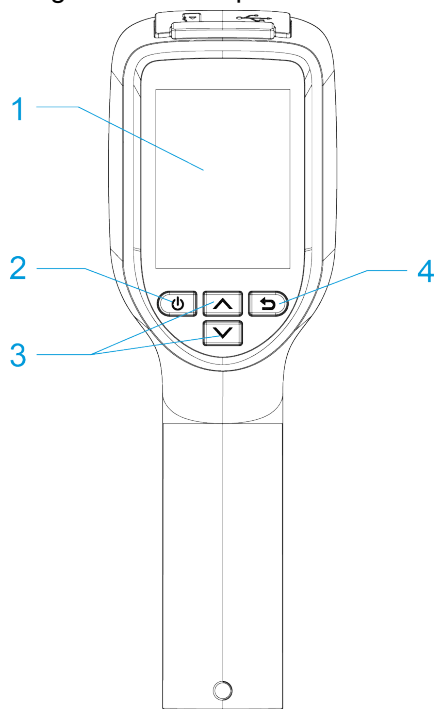

Table 2-1 Front panel description

No.	Component	Description
1	Display screen	Displays live interface and menu interface.
2	Power button	<ul style="list-style-type: none"> <li>Press and hold the power button to power on or off the Camera.</li> <li>On the live interface, press the power button, and the Camera goes to the standby state; under standby state, press any button to wake up the Camera.</li> <li>On the menu interface, press the power button to go to the submenu interface.</li> </ul>
3	Up/Down buttons	<ul style="list-style-type: none"> <li>On the live interface, press the up button to go to the menu interface.</li> <li>On the menu interface, press the up or down buttons to select parameters.</li> </ul>
4	Back button	Exit or return to the previous menu.



## Side Panel

Figure 2-3 Side panel

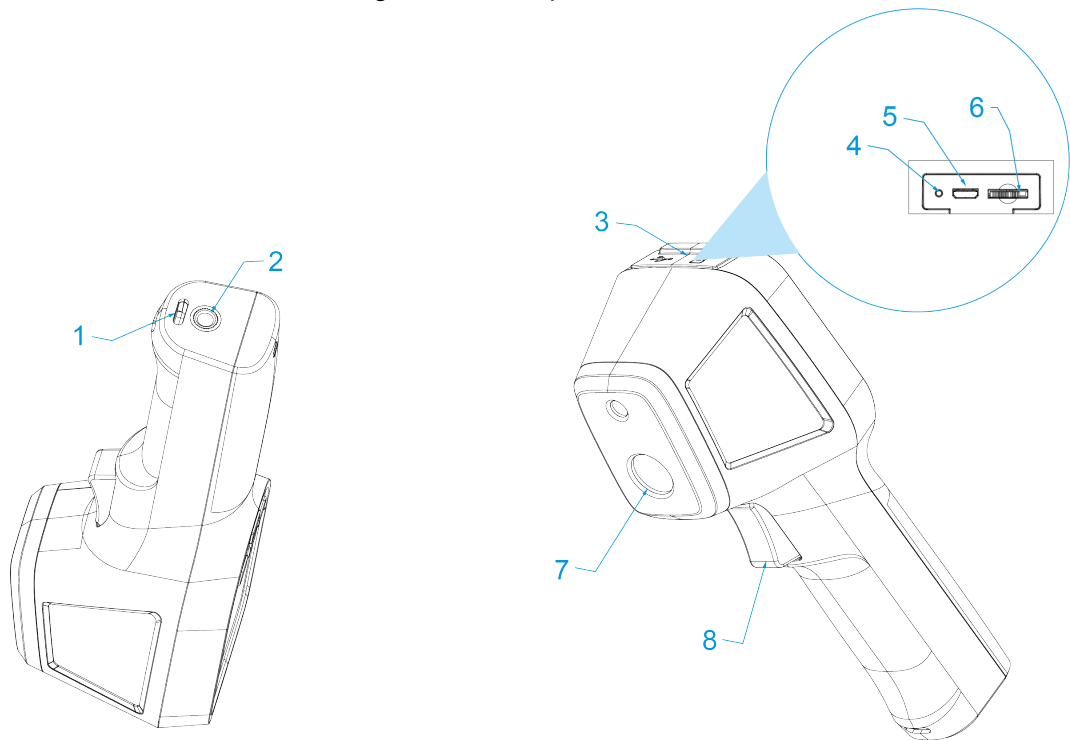



Table 2-2 Side panel description

No.	Component	Description
1	Wrist rope hole	Used for threading wrist rope.
2	Tripod port	Used for installing a tripod.
3	Silicon plug	—
4	Charging indicator light	<ul style="list-style-type: none"> <li>● Charging: Red light on.</li> <li>● Full charging: Green light on.</li> </ul>  <p>The battery can be recharged repeatedly, but it is a wearable product. If the standby time of the Camera has been greatly reduced, please contact the after-sales support to replace the battery.</p>
5	USB port	Used for connecting the USB cable.
6	SD card slot	Used for installing a SD card.
7	Thermal lens	Used for monitoring.

No.	Component	Description
8	Trigger button	<ul style="list-style-type: none"><li>● On the live interface, press the button twice to capture images.</li><li>● On the live interface, press the button 3 times to start recording, and then press 3 times to stop recording.</li><li>● On the menu interface, press the button to return to the live interface.</li><li>● Under standby state, press the button to wake up the Camera.</li></ul>

# 3 Basic Operations



Interfaces might vary with models and the actual interface shall prevail.

## 3.1 Live Interface

Figure 3-1 Live interface

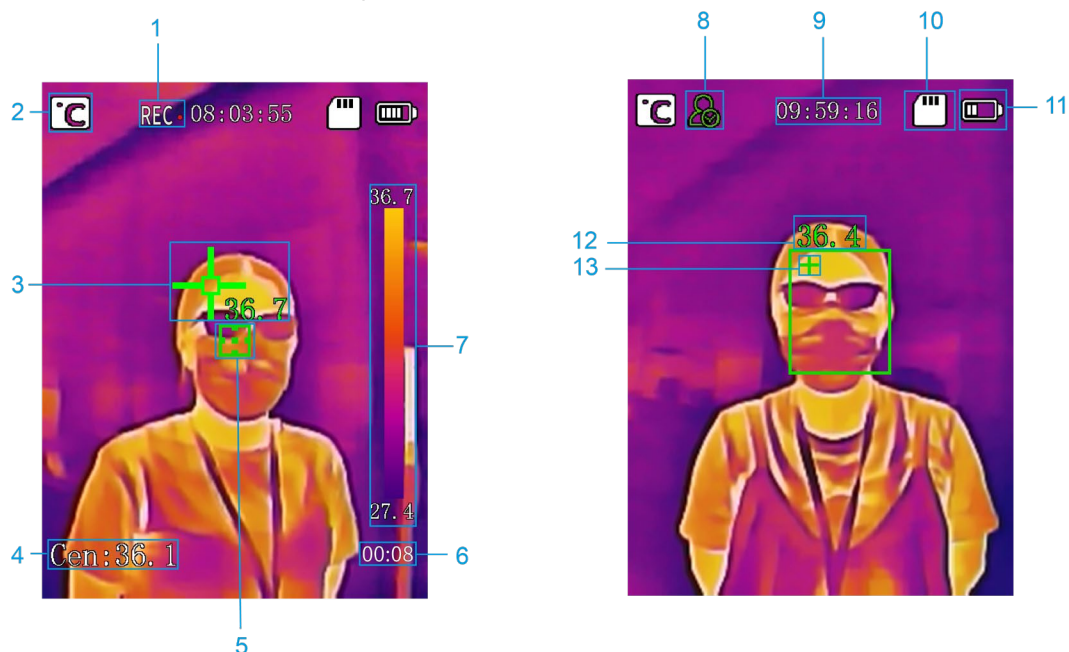

Table 3-1 Live interface

No.	Name
1	Recording videos.
2	Temperature unit.
3	Highest temperature spot.
4	Center spot temperature monitoring.
5	Center spot cursor.
6	Recording duration.
7	Color bar.
8	Head detection mode.
9	Time display.
10	SD card status.
11	Battery status.
12	Temperature monitoring value.
13	Highest temperature in the detection box.

## 3.2 Installing SD Card

If you want to store images and recorded videos, you need to purchase and install an SD card first.

**Step 1** Open the silicone plug on the top of the Camera.

**Step 2** Face the label side of the SD card to the camera screen, and then insert the SD card slowly until you hear a click sound.

**Step 3** Cover the silicone plug.



The SD card does not support hot swapping during image capturing or recording.

## 3.3 Capturing Images

You can capture images manually and record temperature re monitoring information.

In the live interface, press the trigger button twice to capture an image, and the image will be automatically saved to the SD card.



If no SD card is installed, a prompt is displayed indicating that there is no SD card after the capturing operation.

## 3.4 Recording Videos

You can record videos manually.



In the live interface, press the trigger button 3 times to start recording, and then press 3 times to stop recording. The recorded videos will be automatically saved to the SD card.





If no SD card is installed, a prompt is displayed indicating that there is no SD card after the recording operation.



## 3.5 Viewing Images

On the live interface, press  to go to the **Picture Search** interface, and then press  to view images.

- On the **View Picture** interface, press / to switch images.
- Press  to delete the selected images.

## 3.6 Viewing Recorded Videos

On the live interface, press  twice to go to the **Video Search** interface, and then press  to view recorded videos.

- On the **View Video** interface, press / to switch videos.
- Press  to delete the selected videos.

## 3.7 Exporting Images and Recorded Videos

You can export images and recorded videos locally.

**Step 1** On the live interface, press , and the **Menu** interface is displayed.

**Step 2** Press  to select **System Settings**, and then press , and the **System Settings** interface is displayed.

**Step 3** Select **USB Option**, and then press , and the **USB Option** interface is displayed.

**Step 4** Press  to select **USB Flash Drive Mode**, and then press  to confirm.

**Step 5** Open the silicone plug on the top of the Camera.

**Step 6** Connect the Camera to your PC with the USB cable.

**Step 7** Go to the folder where the images and recorded videos are stored, and then copy the images and recorded videos to your PC.

**Step 8** Disconnect the USB cable from your PC after copy.

## 3.8 Upgrade



You can upgrade the Camera through PC or SD card. This section takes upgrade through the SD card for an example. For detailed operation of upgrade through PC, refer to the user's manual.

### Prerequisites

- The upgrade program named "update.img" has been obtained and saved in the root directory of the SD card.
- The SD card is installed on the Camera. See "3.2 Installing SD Card".
- Ensure that the battery capacity exceeds 50% during the upgrade. You can charge the Camera by connecting to a computer or charger.

### Procedure

**Step 1** Turn off the Camera.

**Step 2** Press and hold  and  buttons at the same time to start upgrade.



- Be patient and do not perform other operations during the upgrade.
- Do not disconnect the power supply during the upgrade; otherwise the device might not be able to start.

After the upgrade, the Camera will restart automatically, and then go to the live interface.

**Step 3** (Optional) To back up the new program, turn off and then restart the Camera again. The Camera will back up the program automatically during the restart. Wait until the Camera goes to the live interface.



- Do not perform any operation during the backup.
- The Camera will be automatically restored to the backup program if the upgrade is failed.

## 3.9 Auto Maintenance

Step 1 On the live interface, press  to go to the **Menu** interface.



Step 2 Select **System Settings** > **Auto Maintain**, and the **Auto Maintain** interface is displayed.

You can set auto standby time and auto shutdown time of the Camera.

- Auto Standby

Press  to switch and select time. You can set the auto standby time to 1 minute, 2 minutes, 5 minutes, 10 minutes, or off.

- Auto Shutdown

Press  to select **Auto Shutdown**, and then press  to switch and select time. You can set the auto shutdown time to 5 minutes, 10 minutes, 15 minutes, 30 minutes, or off.

# 4 Temperature Monitoring Configuration



- Interfaces might vary with models and the actual interface shall prevail.
- The following cases will reduce battery life: Enabling head temperature monitoring, sound alarm linkage, snapshot linkage, and video recording.

## 4.1 Temperature Settings

The Camera supports monitoring the real-time temperature of target objects in different scenarios. Temperature monitoring parameters affect the accuracy of monitoring results. You need to configure temperature monitoring parameters before temperature monitoring.

**Step 1** On the live interface, press , and the **Menu** interface is displayed.

**Step 2** Select **Temp Settings**, and then press , and the **Temp Settings** interface is displayed.

**Step 3** (Optional) Select **Centre Spot**, and then press to enable or disable the function. When the **Centre Spot** is enabled, the center spot cursor will be displayed at the center of the live interface. And the monitored temperature of the center spot will be displayed at the lower-left corner of the live interface.

**Step 4** (Optional) Press to select **Color Bar**, and then press to enable or disable the function.

When the **Color Bar** is enabled, the color bar will be displayed at the right side of the live interface.

**Step 5** Configure temperature monitoring parameters.

- Press / to select parameters.
- Press to confirm.
- On the parameter configuration interface, press / to increase or decrease the parameter value.

Table 4-1 Temperature parameter description

Parameter	Description
Pseudo Color	Press  to switch to pseudo color mode.
Emissivity	Set emissivity for different monitoring targets as needed. The default value is 0.98.
Distance	The distance between the monitoring target and the Camera.  Ensure that the actual distance is consistent with this value, otherwise it will affect the temperature monitoring accuracy.
Unit	Temperature unit. Supports: °C, °F and K.



**Step 6** Press to save the configuration and quit.

## 4.2 Temperature Monitoring Settings



The Camera supports temperature monitoring. An alarm will be triggered when the temperature of the monitoring target exceeds the alarm threshold.

Monitoring method includes **Max Temp Point** and **Head Detection**.

**Step 1** On the live interface, press , and the **Menu** interface is displayed.

**Step 2** Press  to select **Temp Settings**, and then press , and the **Temp Monitor** interface is displayed.

**Step 3** Select **Skin Temp Monitor**, and then press .

**Step 4** Press  to select a monitoring method, and then press  to confirm.

**Step 5** Configure temperature monitoring parameters.







- Press  to select parameters.
- Press  to confirm.
- On the parameter configuration interface, press  to increase or decrease the parameter value.





Table 4-2 Parameter description of temperature monitoring

Parameter	Description
Alarm Settings	<ul style="list-style-type: none"> <li>• Alarm Threshold: Set the alarm threshold value. An alarm will be triggered when the temperature of the monitoring target exceeds the alarm threshold. On the live interface, the temperature that exceeds the alarm threshold flashes and is displayed in red.</li> <li>• Snapshot: Set whether to enable snapshot when an alarm is triggered.</li> <li>• Buzzer: Set whether to beep when an alarm is triggered.</li> </ul>  <p>Enabling snapshot or buzzer will reduce the battery life of the Camera.</p>
EnvTemp Mode	<p>Set ambient temperature mode.</p> <ul style="list-style-type: none"> <li>• Self-adaptive Mode: The Camera calculates the ambient temperature automatically. Select <b>Self-adaptive Mode</b>, and then press  to set the current ambient temperature as the reference temperature.</li> <li>• Manual Mode: Set the current ambient temperature manually.</li> </ul>
Temp Correction	<p>The difference of the temperature monitoring environment might cause the temperature deviation between the monitored temperature and the actual temperature. You can select multiple monitored samples for testing, and then correct the temperature deviation by this parameter according to the comparison between the monitored temperature and the actual temperature. For example, if the monitored temperature is 0.5°C lower than the actual temperature, the correction value is set to 0.5°C; if the monitored temperature is 0.5°C higher than the actual temperature, the correction value is set to -0.5°C.</p>

**Step 6** Press  to save the configuration and quit.



## 5 System Settings

On the live interface, press  to go to the **Menu** interface. Press / to select **System Settings**, and then press , and the **System Settings** interface is displayed. You can configure USB options, time and date, screen brightness, auto maintenance, restore defaults and restart the Camera. For details, see the user's manual.