

**SUNBA**® Lite Series

# Network PTZ Camera

Premium Engineering. Durable Outdoor Surveillance  
Ideal for House or Project Site

User Guide V12.0

For 405-ECO V2, 405-D20X 4K V2, 405-D25X 4K



2024/01  
Version 12.0

# MENU

1. Camera Bench Test	01
2. Camera Setup by Smartphone	03
3. Camera Setup by VMS Client	05
4. WiFi Application	07
5. Mounting Outdoor	11
6. Web Access	12
7. Assign a Static IP	15
8. Access by 3rd Party Software	15
9. Remote Access	16
10. Presets, Patrol and Pattern	18
11. The Full Preset List	19
12. Camera Configuration	22
13. Account Management	23
14. Motion Detection	23
15. Face Capture	24
16. FTP Communication	24
17. Cable Waterproof Measures	25
18. Audio Setting	26
19. Auto Tracking Setup	27

## FCC Warning (U.S.A)

The device has been tested in compliance with limits set by Part 15 of Federal Communication Commission (Class B). The operation of the device is thus limited by the following two conditions:

1) it is not permitted to cause harmful interference to any authorized radio communications, and 2) it must accept any interference it receives.



WARNING: Please test the camera indoor before mounting it outside. Stay at least 24 hours to test both daytime and night vision IR LED.

# 1. Camera Bench Test



When you take the camera out of the box, please test the camera indoor first before mounting outside.

## Type A: With DC12V Adapter (non-PoE)

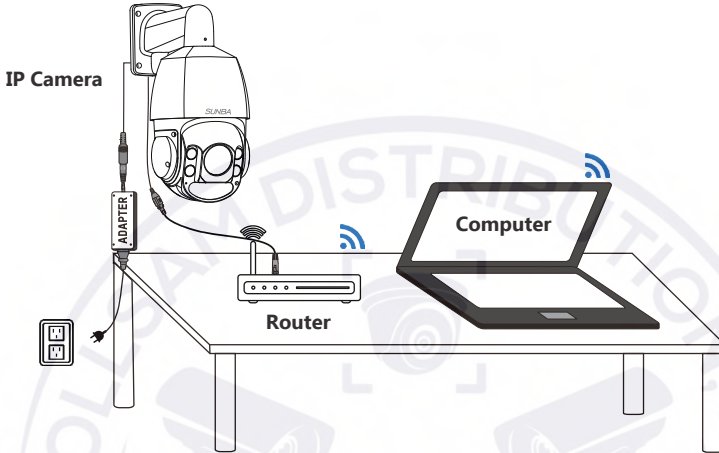

Do NOT extend the power cable during the bench test because DC power drops quickly along the transmission. A bench test helps you rule out all problems caused by power supply. Underpower causes problems such as 1) PTZ issues 2) unstable infrared (camera reboots repeatedly) and 3) spinning dome.

## Type B: With PoE Injector/Switch

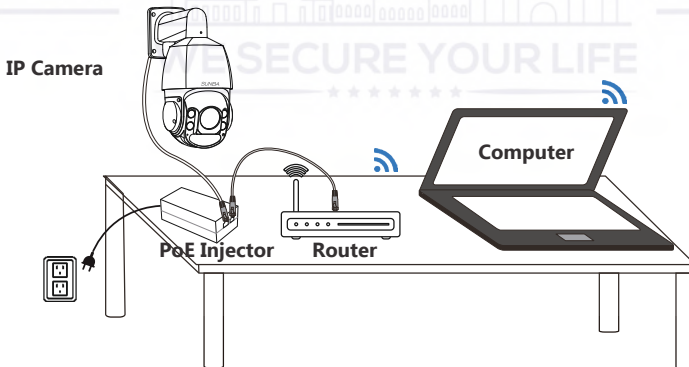

## PoE Standard

It is important to note that all Sunba pan tilt zoom cameras require to be powered by PoE+/++ adapters (injector/switch) with 802.3at/bt standard. Conventional PoE standard 802.3af delivers only 15.4W per port and using those adapters would cause underpower.

Power Gauge (PD)	PoE Standard	Support DC12V Adapter?
≥25W	802.3at/bt	Yes

Note: 802.3at is also known as PoE+; 802.3bt is known as PoE++.

### What are you testing in this stage?

#### 1. Does the camera rotate when powered up?

When powered up, the speed dome automatically begins a self-diagnostic process during which the camera will pan horizontally and vertically to make sure PTZ, lens and other parts of the camera are functional. Please contact our technical staff if a self-test does not happen on your unit. Please refrain from disassembling the unit before contacting us.

#### 2. Live View and Picture Quality

Check the video streaming quality.

#### 3. Pan Tilt and Zoom

Check whether the camera performs the pan, tilt, zoom actions properly.

#### 4. Night Vision

Shield the camera front lens, turn off the lights and draw the curtains to see if the camera is able to automatically turn to infrared night vision mode.



- ✓ Connection Good
  - ✓ Power Good
  - ✓ Video and Control Good
  - ✓ Tested Day and Night
- Guess we are ready to mount it outside.

**Questions? Ask** [support@sunba.net](mailto:support@sunba.net)

## 2. Camera Setup by Smartphone

This section will provide the user with information on how to setup the PTZ camera using smartphone for the first time.

video tutorial [smartphone.sunba.net](http://smartphone.sunba.net)  XMEye

  APP Download   iOS

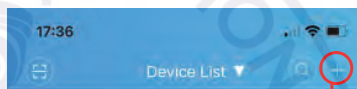
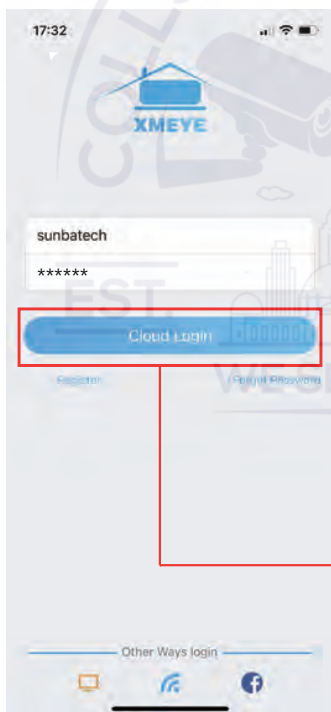

② Click the "+" icon to add device.

NOTE: iSunba/iSunba Pro/XMEye These APPs are suitable for Sunba Lite Series cameras.

① Register to select "Cloud Login" (push notification requires a cloud account to store picture alert).



③

Remote or with 4G: manually scan or enter the camera QR code to add device.

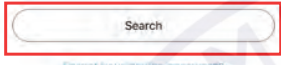
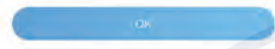
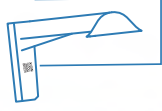
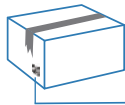

The app automatically shows all Sunba devices in LAN.

Use "Search" if your camera and smartphone are connected to the same WiFi.

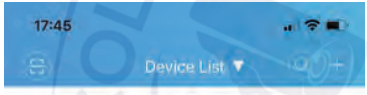







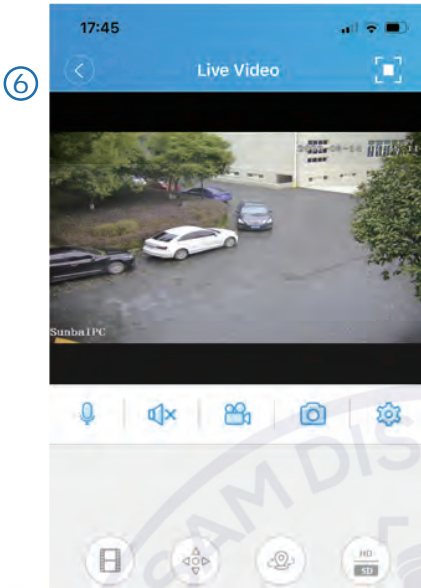

④ Press the camera to watch live view.



⑤ Modify other settings such as password for the camera.



Control pan, tilt and zoom, watch live view and set/delete/call presets from this page.

-  Press to speak. (device must support speaker)
-  Turn on/off microphone.
-  Record a video and save the clip to your smartphone.
-  Take a snapshot and save the image to your smartphone.
-  Check playback.
-  PTZ control.
-  Switch between HD/SD display.
-  Set/call preset/cruise.

### 3. Camera Setup by VMS Client

This section will provide the user with information on how to setup the PTZ camera using their computer.

#### Step 1: Install VMS from the CD-ROM or Download form sunbatech.com

Input the default **software account** below. The account is to ensure no one can have unauthorized access to your surveillance software. This is not the credential for individual IP camera.

**VMS for PC: admin/admin**

**VMS for Mac: admin/(blank)**

#### Step 2: Open the Device Manager page.

Click **"IPv4 Search"** and select the camera, then click **"add"** to connect the device.

Try the following if no device shows up:

- A. Temporarily disable the firewall;
- B. Connect the camera directly to your parental router;
- C. Connect the camera directly to your PC/Mac for testing;
- D. Contact support@sunba.net



Online Devices: 8

Name	CloudID	IP/Port	Protocol	Group
192.168.1.208	1d8a34814c36c3c9	192.168.1.208:34567	XM	Default Group
192.168.1.240	c1829c21d9e8f8e9	192.168.1.240:34567	XM	Default Group
192.168.1.242	Not Available	192.168.1.242:8000	Onvif	Default Group
192.168.1.245	Not Available	192.168.1.245:80	Onvif	Default Group
192.168.1.249	Not Available	192.168.1.249:8000	Onvif	Default Group
192.168.1.250	4e2d7baa37ede662	192.168.1.250:34567	XM	Default Group
192.168.1.27	4e2d7baa37ede662	192.168.1.27:34567	XM	Default Group

IPV4 Search    IPV6 Search    Add    Cloud Add

All Devices: 0    Online: 0

Name	CloudID	IP/Port	Version	Group	Connect	Privd Status	Record Status	Connections	Operation
------	---------	---------	---------	-------	---------	--------------	---------------	-------------	-----------

In order to login device, modify ip automatically

Manual Add    Add Group    Remove    BackUp    Import

If you checked this function, VMS will automatically modify the IP address of your camera to adapt to the same gateway as your PC. If you do not need VMS to automatically modify the camera IP, please uncheck this function.

Now the camera status should show **"Connected"**.

Online Devices: 7

Name	CloudID	IP/Port	Protocol	Group
192.168.1.208	c1829c21d9e8f8e9	192.168.1.208:34567	XM	Default Group
192.168.1.242	Not Available	192.168.1.242:8000	Onvif	Default Group
192.168.1.245	Not Available	192.168.1.245:80	Onvif	Default Group
192.168.1.249	Not Available	192.168.1.249:8000	Onvif	Default Group
192.168.1.250	4e2d7baa37ede662	192.168.1.250:34567	XM	Default Group
192.168.1.27	4e2d7baa37ede662	192.168.1.27:34567	XM	Default Group
192.168.1.91	Not Available	192.168.1.91:80	Onvif	Default Group

IPV4 Search    IPV6 Search    Add    Cloud Add

All Devices: 1    Online: 1

Name	CloudID	IP/Port	Version	Group	Connect	Privd Status	Record Status	Connections	Operation
192.168.1.208	1d8a34814c36c3c9	192.168.1.208:34...	V5.00.R02.L5330747.10010.349F17.00...	Default Gr...	Completed			0	

In order to login device, modify ip automatically

Manual Add    Add Group    Remove    BackUp    Import

"Connected" status indicates the camera is online.

#### Tricks:

The camera's default ports are ONVIF 8899, TCP 34567, HTTP 80 and RTSP 554. Those values must also be unique to each other.



### Step 3: Live View

Please go to the "Live View" page.



## 4. WiFi Application



This chapter only applies to WiFi Version (405-ECO WiFi/ 405-D25X WiFi etc)

This section will provide the user with information on how to setup the WiFi connection.

video tutorial [wifiset.sunbatech.com](http://wifiset.sunbatech.com)



## Method A: Search and add the camera by smartphone.

After the camera is powered on and completes the self-test, you can directly search and add the camera via XMEye APP on smartphone.

**Attention:** Make sure the distance among the camera, phone and the router within 2meter.



**Attention:** Make sure your phone is in **2.4GHz WiFi** network, and 5GHz or other network is not supported.

10:47 Add Device

Manual Add  WiFi Config

ASUS-2.4G  
\*\*\*\*\*

You want to connect the equipment of the production date is after June 2015?

No/Not Sure  Yes

13:54 Add Device

4 Click Yes

5 Device searching. Click the green IPC icon

13:55 1d8a34814c\*\*\*\*\*3c9

1d8a3481\*\*\*\*\*3c9

1d8a34814\*\*\*\*\*3c9

admin

(password)(Default is null)

\*The login name is 4-15 characters, case sensitive.  
\*password contains 8-16 characters, and must...

13:57 Device List

1d8a3481\*\*\*\*\*3c9  
1d8a3481\*\*\*\*\*3c9

CAM01

6 Enter password.

7 Click and start live view.

**Tips:** 📖

If the search fails, please refer to the following two ways to default the camera, and then refer to the above steps to search again.

1. Please manually press the button to default the camera as shown below

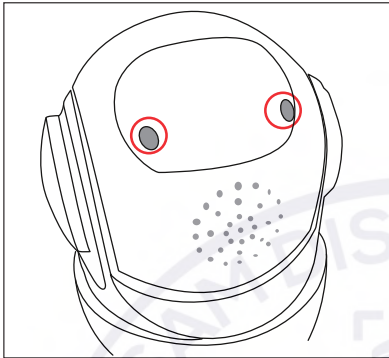

Remove the 2 screws to take off the camera TF slot cover.

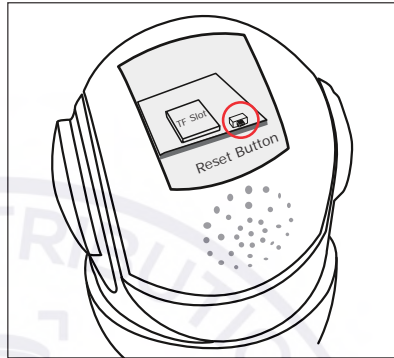

Press and hold the black button for about 8~10 seconds.

2. You can directly connect the camera with a PC or laptop, and default the camera via VMS/IE browser.

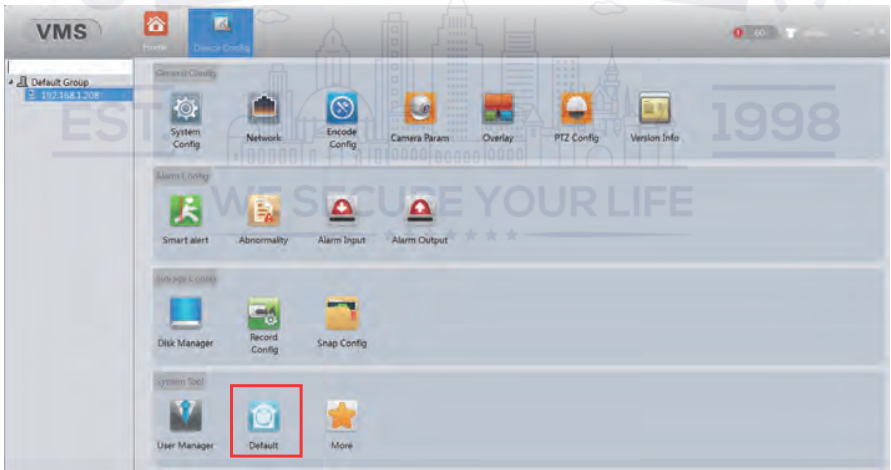

## Method B: Enable WiFi function via VMS/IE browser.

Please refer to Chapter 3 and Chapter 6 for the steps to access the camera through the VMS/IE browser.

After adding the camera, please go to Device Config > Network > WiFi  
(In Internet Explorer, please go to Device Config > Netservice > WiFi)

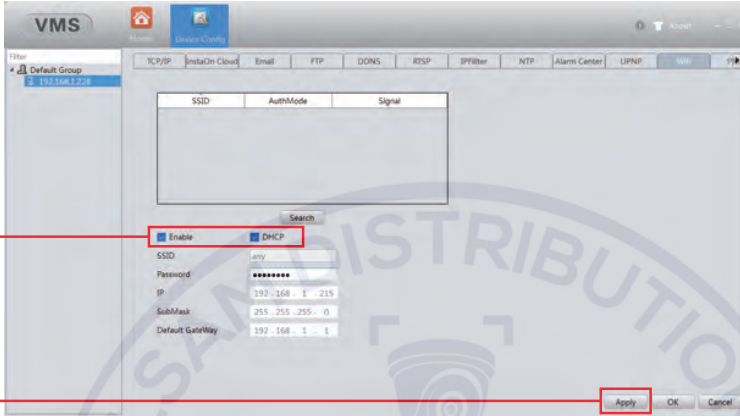

- 1 Click Enable and enable DHCP.
- 2 Click Apply to save the settings.
- 3 Click Search to select a WiFi with stable and strong signal.

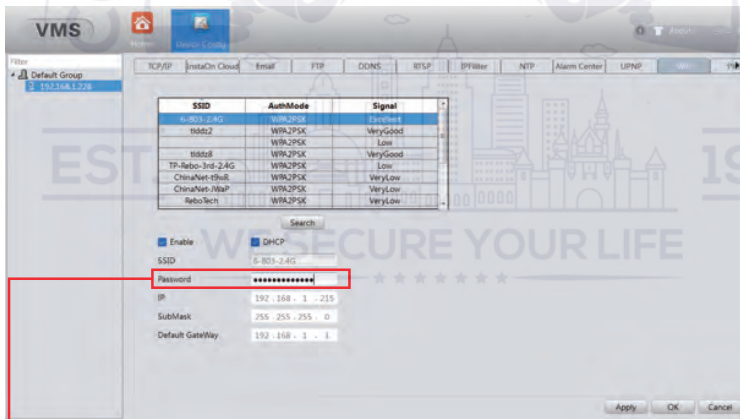

- 4 Fill in the correct WiFi password.
- 5 Click Apply and OK to save the settings.

**Attention:** After checking Enable in the first step, you must click Apply to save the settings, otherwise the WiFi signal will not be searched.

# 5. Mounting Outdoor



Please complete bench test (see Chapter 1) before mounting the camera outdoor.

## Wiring Type A: Power of Ethernet Solution

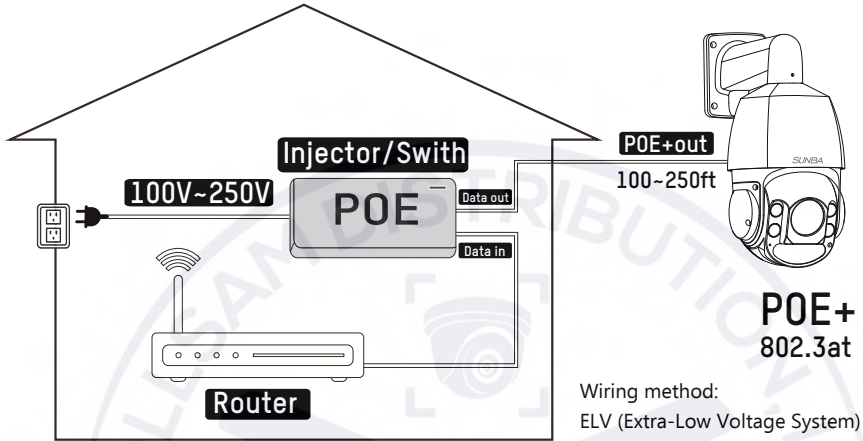

## Wiring Type B: Non-PoE (DC12V) Solution

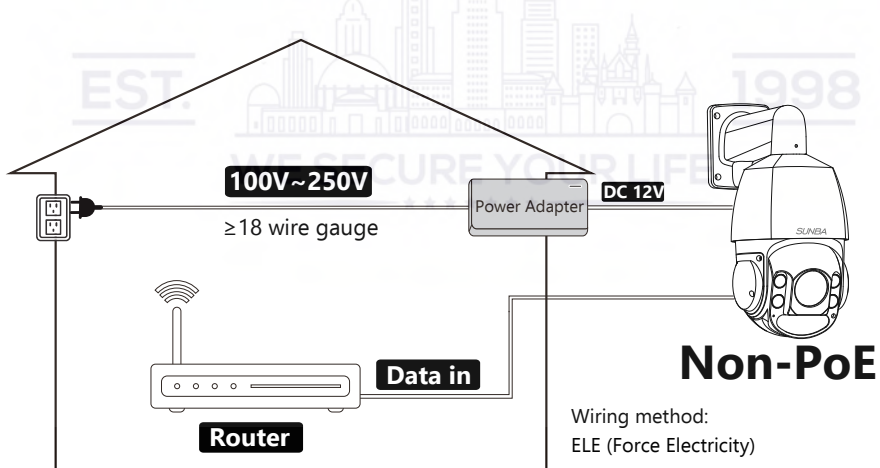

### For Non-PoE Application (if you extend the power):

The camera may not work properly if the power reaches the camera is below 12V due to resistance along the extended DC line (distance dependent). If that happens, please make your AC power source near the camera, and connect it with our default adapter you received from the package.

For extension, you can select from AC power extension cable (no distance limit) or thick ( $\geq 18$  AWG) DC power extension cable.

### Risk Relevant

1. Using 24VAC or higher voltage adapter (16V, 24V) will immediately damage the camera and void the warranty.
2. The camera will be exposed to high risks of motherboard damage and void the warranty if you use passive PoE injector/splitter.

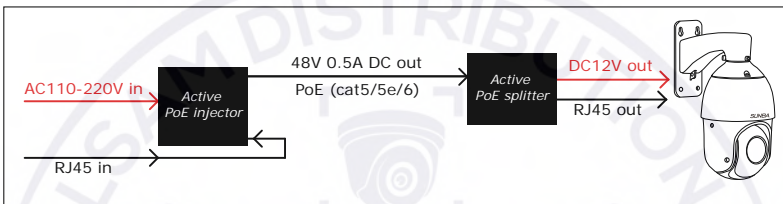

Active PoE Injector/Splitter are **allowed** if you use PoE to power non-PoE camera.

## 6. Web Access

### Step 1: Check Device IP from VMS or Device Manager tool

Users can download VMS or Device Manager from the CD-ROM or Sunbatech.com. Both software will display the current IP of the camera.

NO	IP Address	Port	Destrib	Mac Address	CloudID
<input type="checkbox"/> 1	192.168.1.12	34567		00:00:11:06:83:24	d#25d48157925
<input type="checkbox"/> 2	192.168.1.70	34567		00:12:17:58:e3b9	c363f2750087b

Check device IP address

IP Address: 192.168.1.12  
Subnet Mask: 255.255.255.0  
Gateway: 192.168.1.1  
HTTPPort: 80  
TCPPort: 34567  
Mac Address: 00:00:11:06:83:24  
CloudID: d#25d4c



## Step 2: Start a web browser

Enter the IP address of your camera in the browser's URL bar.

If you have changed the default http port (80) of the camera, you need to enter IP: *http port*.

e.g: 192.168.1.211:8787

Note: After 2024, the lite series already support Chrome browser live view and camera configuration (Windows Systems Only), but the prerequisite is to install web plugins.

## Step 3: Install the web plugin

If you have not installed any plugins on your computer, the following prompt will appear:

Tip: If Google Chrome still prompts you to download and install the playback tool

Step 1: Enter in the Google Chrome address bar:

'chrome://flags/#block-insecure-private-network-requests'

Step 2: Search for the 'Block insecure private network requests' configuration item

Step 3: Close Google Chrome and reopen the webpage.

Please click here to download and install the playback tool

Click the blue button to download the video player plugin.

If your PC is not connected to the internet, you need to download it after connecting to the internet. If your computer is unable to pop up the download box, you can also manually input this URL to download:

<http://xmsecu.com:8080/ocx/VideoPlayToolSetup.exe>

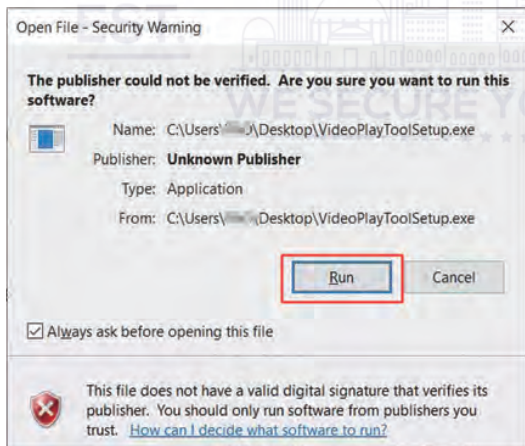

Some browsers may intercept downloads, please keep this [VideoPlayToolSetup.exe](http://xmsecu.com:8080/ocx/VideoPlayToolSetup.exe) file and allow it to run on your PC. (As the software does not have a signature, the system will default to blocking it). This is a video player decoder on the web. If your antivirus software blocks it, please allow it.

#### Step 4: Select Language

You can change the language from the upper right corner. Changes only take effect after you successfully install the plugin.

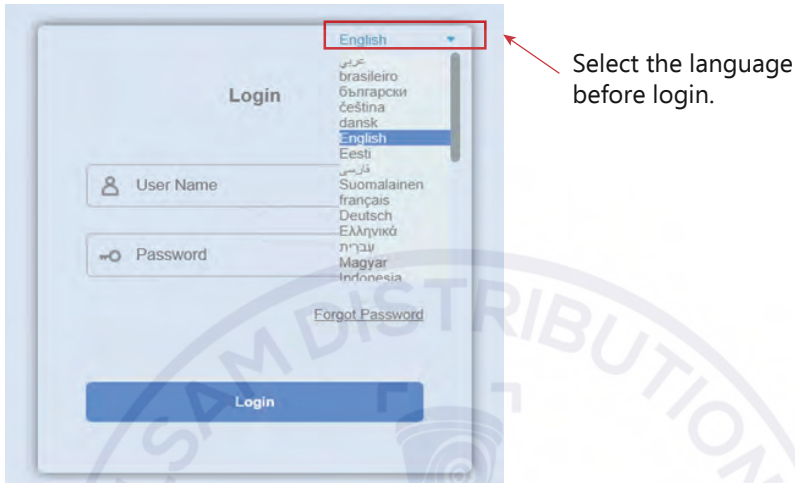

#### Step 5. Enter Username and Password

Enter username and password. The username is admin with no password by default. Please **change the admin password** after log in to protect your privacy by referring to Chapter 13.

#### Step 6. Select Stream

Go to <left tool bar> and connect with either main stream (clear, better quality, higher network requirements) or extra stream (fluent, lower network requirements).

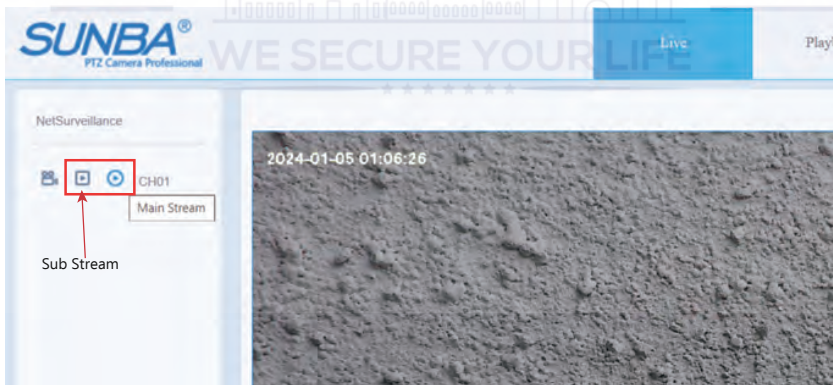

# 7. Assign a static IP

Step 1: Enter Device Config Page of Internet Explorer or VMS, and select the Network tab.

Step 2: Unselect the DHCP option.

Step 3: Change the camera IP and click "Apply" to save the changes. Power cycle the unit to activate the new setting.

# 8. Access by 3rd Party Software

This chapter introduces how to add the camera to a selected few popular 3rd party software.

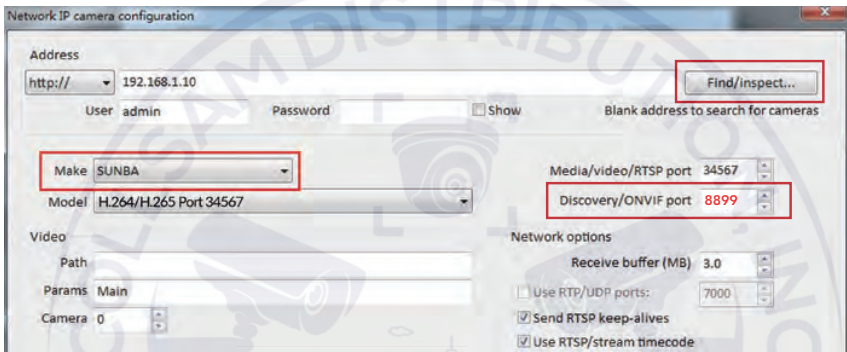

**Blue Iris (in Windows)**

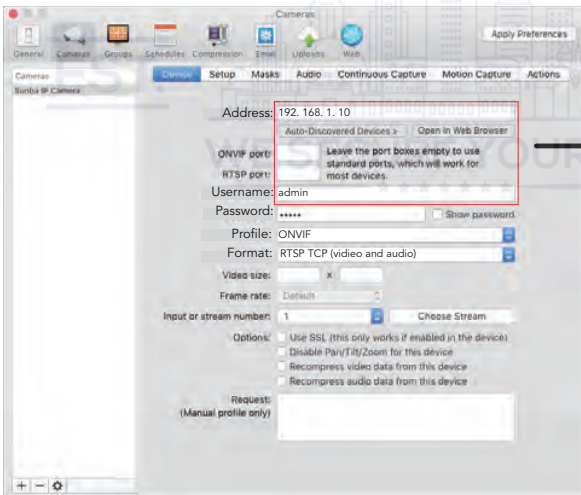

Fill in the boxes with corresponding network info of your camera. By default, the ONVIF port is 8899 and RTSP port is 554. Make sure the encode is set to H.264.

**Security Spy (in Mac)**

## Other third party IP camera management tools

There are many other IP camera management tools you can use. Above we attached the setting from the most popular software in Windows and Mac. Some software/NVR requires manually adding the camera with the camera's ONVIF protocol and the ONVIF port 8899.

Note : In 3rd party software/NVR, due to the level of customization for ONVIF by different surveillance manufacturers, only ptz, video and recording may work depending on specific ONVIF version.

If you have particular 3rd party software that you would want to use with Sunba PTZ cameras, we are happy to supply resources and assistance we can offer to integrate our protocol. Please contact us via support@sunba.net.

# 9. Remote Access

## Type 1: Sunba Cloud (P2P)

P2P cloud technology enables customers to remotely access, control and configure their cameras through internet even if you are thousands miles away.

**Warning:** P2P function may not work if you modify the default media port (34567) of the camera or the DNS of your camera is not on the same subnet as your router. Your NAT status by DeviceConfig->Version needs to be "connected" before you are able to access your camera through P2P.

1) Find Your Sunba Cloud ID:

**Note P2P Code = Cloud ID = Serial Number**

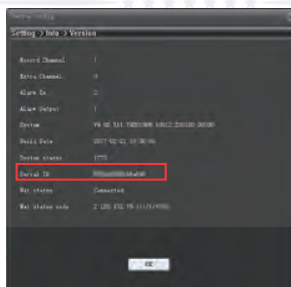
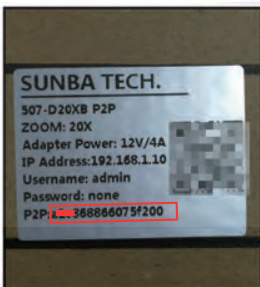

### Tips:

Go to Sunba website FAQ page and type keyword "mobile" to gain the setup page for popular smartphone app such as XMEye, TinyCam Pro, IP Cam Viewer.

2) Enter the Cloud ID in Sunba Cloud Platform for remote access:

Internet Explorer:

Please go to [xmeye.net](http://xmeye.net) and use "**Device Login**". Enter the cloud ID of the camera and associated username and password.

The image shows two side-by-side screenshots. The left screenshot is a 'VMS Add Device' form with the following fields: Device Name (Sunba), Group (Default Group), Login Type (CloudID), CloudID (987dc021338\*\*\*\*\*), UserName (admin), Password (empty), and Vendor (SUNBA). There are 'Save And Continue', 'OK', and 'Cancel' buttons at the bottom. The right screenshot is the 'xmeye.net (Internet Explorer)' login page, showing 'By User' and 'By Device' tabs. The 'By Device' tab is active, showing a text input for the device ID (987dc021338\*\*\*\*\*), a dropdown for the user (admin), and a password field. There are 'Verify' and 'Login and Preview' buttons at the bottom.

## Type 2: Port Forwarding



Please refer to [portforward.sunba.net](http://portforward.sunba.net) for more instructions.

Please forward BOTH http port (80 by default) and TCP (media) port (34567 by default) and refer to the manual of your router for detailed steps of port forward in order to remotely access using a WAN IP. Other apps such as Tiny Cam or IP Cam Viewer may require you to forward ONVIF and RTSP port as well. *Disclaimer: Though it is a popular method, Sunba does not recommend setting up port forwarding as it opens all ports to the public network and increases chances of information leak.*

## Type 3: RTSP

Please use the following URL along with any 3rd RTSP service provider: "rtsp://IP:554/user=admin&password=&channel=1&stream=0.sdp?real\_stream" where 0 = mainstream and 1 = substream  
For example with the default network setting:  
rtsp://192.168.1.10:554/user=admin&password=&channel=1&stream=0.sdp?real\_stream

## Type 4: VPN (Virtual Private Network)

This is recommended for customers who have static IP address and advanced router functions.

First, your router MUST support VPN. Then please refer to the corresponding manual of your router to establish a VPN for the local network where the camera is connected to. For example, the VPN was setup for the router at your home where the camera is installed. Please remember the username and password of the VPN. Then, at any remote location, you can always setup a new network using VPN to remotely access your camera at home.

- 17 -



# 10. Presets, Patrol and Pattern

**Note: For other software please refer to the manual of the third party software.**

Enter the number and hit "+" to set/add/save a  
Enter the number and hit "-" to delete a preset.  
Enter the number and hit "\$" to call a preset.

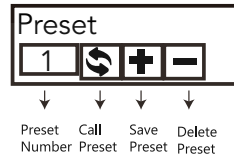

## PTZ Preset Position

Sunba dome cameras can set preset PTZ positions for which cameras can memorize and travel directly by calling the preset. Preset positions are represented by numbers. You need to "add" a preset and then "call" it. You can always "delete" them later.

## Special Presets



Check Special Preset via [specialpreset.sunba.net](http://specialpreset.sunba.net)

Special presets are preset numbers associated with advanced commands that cameras can follow to modify/enable settings such as changing infrared mode, setting up camera auto scan boundaries etc. You can call the preset directly (no need to "add" a preset as they are pre-existed) according to **The Full Preset List**.

## Patrol

The PTZ camera can travel from one preset to another by order. A patrol is usually named as a tour or a cruise. The total presets included in a patrol can be up to 10. To activate a patrol, first you will need to save corresponding presets you want to tour across. For example, preset 1-10 can be called by using special preset 88 (see The Full Preset List).

## Pattern

Different from patrol, which enables the camera to travel between different points, patterns are continuous sets of movement that Sunba cameras can perform in a record and replay fashion. Note: Patterns will not be activated unless Motion Detection and Video Blind are disabled.

When using 84 + Add Preset to set a pattern scan, you must use direction & zoom key to set the actions and click Iris+ key to end the pattern setup, prompt as follows:

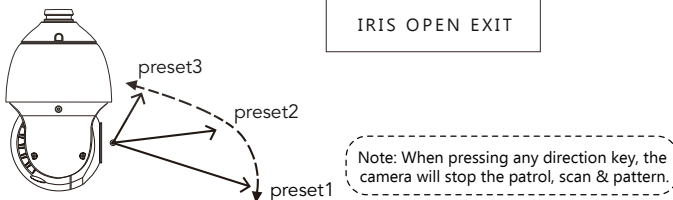



# 11. The Full Preset List

Special Presets	Action	Function
0~50 Preset	Regular preset points	REGULAR PRESET POINTS
XXX + Add Preset	Set preset XXX.	PRESET IS SAVED XX
XXX + CALL	Call preset XXX.	PRESET XX
81 + CALL	Reset the PT position	CALIBRATE
47 or 81 + Add Preset	Set the left boundary of frame scan	LEFT BOUNDARY
48 or 82 + Add Preset	Set the right boundary of frame scan	RIGHT BOUNDARY
82 + CALL	Start frame scan ( auto scan from left side to the right side)	L&R SCAN
83 + CALL	Clear all preset	CLEAR PRESET
84 + Add Preset	Set pattern followed by different action inputs; confirm by clicking "IRIS+" button	START PATTERN, SET PATTERN XX; COMPLETE
84 + CALL	Start pattern	START PATTERN
85 + CALL	Patrol from 1 to 40 preset	START PATROLS
88 + CALL	Patrol from 1 to 10 preset	START PATROL1
89 + CALL	Patrol from 11 to 20 preset	START PATROL2
90 + CALL	Patrol from 21 to 30 preset	START PATROL3
91 + CALL	Patrol from 31 to 40 preset	START PATROL4
92 + CALL	Default	DEFAULT
98 + CALL	360° continuous scan	HORIZONTAL SCAN
102 + CALL	Set the IR mode to auto (default)	IR AUTO
103 + CALL	Manually turn IR on (all side on)	IR ALL ON
97 + 180 + CALL	Set the Park Action to None	PA NONE
97 + 181 + CALL	Set the Park Action to 360° continuous scann	PA 360
97 + 182 + CALL	Set the Park Action to frame scan ( auto scan from left side to the right side)	PA L&R SCAN
97 + 183 + CALL	Set the Park Action to preset 1	PA PRESET1
97 + 184 + CALL	Set the Park Action to preset 8	PA PRESET8
97 + 185 + CALL	Set the Park Action to patrol 1	PA PATROL1
97 + 186 + CALL	Set the Park Action to patrol 2	PA PATROL2
97 + 187 + CALL	Set the Park Action to patrol 3	PA PATROL3
97 + 188 + CALL	Set the Park Action to patrol 4	PA PATROL4
97 + 189 + CALL	Set the Park Action to pattern	PA PATTERN
97 + 190 + CALL	Set the Park Action to patrol 5	PA PATROL5
97+160+CALL ..... 97+179+CALL	Set the Park Action Start Time to 15s; ..... (5 second added per preset increment) Set the Park Action Start Time to 75s;	PARK ACTION DWELL TIME=15S; ..... PARK ACTION DWELL TIME=75S;
97+200+CALL ..... 97+215+CALL	Set the Patrol Dwell Time to 10s; ..... (5 second added per preset increment) Set the Patrol Dwell Time to 85s;	PATROL DWELL TIME=10S; ..... PATROL DWELL TIME=85S;
97+225+CALL ..... 97+229+CALL	Set the Frame Scan Speed to 5s; ..... (5 second added per preset increment) Set the Frame Scan Speed to 25.	SCAN SPEED=1; ..... SCAN SPEED=5.

# 12. Camera Configuration



### HDD Info:

The information of the storage device (TF card).

### LOG:

Access the events, alarm and activity record of camera.

### Version:

Check the serial number of the camera, and the build date of the firmware.

### Reboot:

Restart the camera.

### Upgrade:

Upgrade the firmware of the camera. You need to download the upgrade the file ("bin" format) first.

**Image Storage:** Take timed snapshot and store it to Email, FTP or TF Card (if supported).

### Record:

Set camera recording plan and mode. The "manual" and "stop" selection allows you to manually turn on and off, and the "timing" allows you to set the schedule where recording takes place.



**Video Motion:**

Enable motion detection alert formats (buzzer, email, recording, snapshot & FTP etc), region, and sensitivity. Set motion detection video recording time.

**Video Blind:**

Set an alarm when the vision of the camera is covered (usually by house breakers using clothes).

**Video Loss:**

Set an alarm when a video loss happens.

**Alarm Input:**

External connection linkage alarms such as infrared sensor etc (not built-in by camera, need additional support in qualified NVR).

**Alarm Output:**

Alarm output can be an external lights, siren, etc. (not built-in by camera, need additional support in qualified NVR).

**Abnormal:**

Set an alarm for special events such as storage device access failure or IP conflict with other devices.

**How to Access the Device Config:**

For IE: Click "DeviceCfg"

For VMS: Choose Device Config

(PS: You must add the camera via Sunba protocol, not ONVIF)



**General:**

Change system language and date.

**Encode:**

Change resolution, bit rate and other factors that affect video quality and connectivity. Enable/Disable audio.

**Network:**

Configure the camera's IP address, gateway, DNS etc.

**NetService:**

Configure NTP, email alert, WiFi and other services.

**GUI Display:**

Customize camera name, time title and other display setting.

**Camera Parameter:**

Configure camera parameter such as exposure level, wide dynamic range, shutter speed, image direction (flip, mirror) etc.

**HDD Manage:**

Manage the storage device (TF card).

Account: Add, delete and change account info (username/password) and their authority level.

**AutoMaintain:**

Set the automatic reboot plan and empty the cache of the camera.

**Default:**

Set the current camera configuration info to the default.

**ImportExport:**

Import/Export the configuration and log of the camera.

## 13. Account Management

**Warning:** Camera accounts are **NOT** the same as VMS software account. When you open VMS, a prompt will ask you to enter password for accessing the VMS program. This account is set to prevent unauthorized use of the VMS software on your desktop.



Account for VMS Software  
**NOT** for Camera

Camera accounts can only be managed by its native clients. Third party software will not be able to modify any accounts information as it doesn't have access to the camera's private protocol.

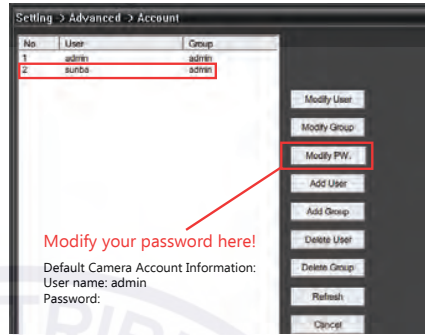
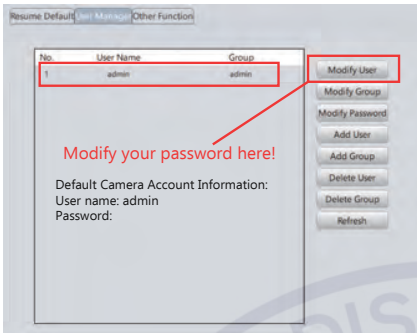

VMS: Device Config->Tool Manager->User Manager

CMS/IE: Device Config-> Account

### Group and User Permission:

You can set a group that shares the same level of permission for camera control and view. For example, you can set several users to a "guest" group that has limited control over the camera.

### Allow Multiple Access :

Please remember to check the "sharable" or "reusable" option when adding a user if you wish to have the same user account accessed by multiple people.



To protect your account safety, please always remember to modify your default password!

## 14. Motion Detection

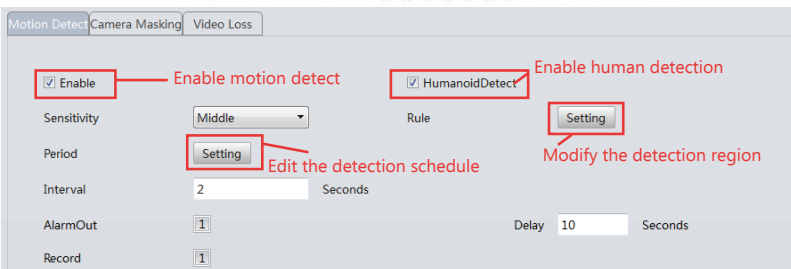

**Human Detection:**

Human-shape detection will filter out other motion objects and have the camera only trigger motion alarms when human-shapes are detected.

**Buzzer:**

Must have a siren connected with the alarm interface of the NVR to enable this option.

**Send Email:**

Enable this and enter your email information via Device Config-> NetService (Network in VMS). You can also enable the snapshot option to activate email alert with snapshots.

**Write Log:**

A log will be popped on the screen every time an alert is received.

**FTP:** See Chapter 16.

**Phone Report:**

Enable this option, register an account in the XMEye app of your smartphone (or via xmeye.net) and activate push notification to receive text alerts.

## 15. Face Capture

The face capture feature is only supported by specific models (For details, you can contact us via [support@sunba.net](mailto:support@sunba.net)), and needs to be coupled with the Sunba NVR model F8009SE/F8010SE to be able to capture, store and browse snapshots of human faces. Firmware upgrade might be required to realize this feature. For detailed steps of setup, please refer to the user manual of Sunba NVR.

## 16. FTP Communication

You can upload motion detection snapshots and videos to your FTP.

**Step 1:** Please remember to check the "Detect" option in the Snapshot Config or Record Config under Device Config.

**Step 2:** VMS: Device Config-> Network->FTP  
CMS/Browsers: Device Config->NetService->FTP



Week	All days	General	Detect	Alarm
TimeSection1	00:00 - 23:59	<input checked="" type="checkbox"/>	<input checked="" type="checkbox"/>	<input checked="" type="checkbox"/>
TimeSection2	00:00 - 23:59	<input type="checkbox"/>	<input type="checkbox"/>	<input type="checkbox"/>
TimeSection3	00:00 - 23:59	<input type="checkbox"/>	<input type="checkbox"/>	<input type="checkbox"/>
TimeSection4	00:00 - 23:59	<input type="checkbox"/>	<input type="checkbox"/>	<input type="checkbox"/>

Motion Detect | Camera Masking | Video Loss

Enable

Sensitivity: Middle | Region: Setting

Period: Setting

Interval: 2 Seconds

AlarmOut: Channel1 | Enable  | Delay: 10 Seconds

Record: Channel1 Enabl | Enable  | Delay: 10 Seconds

Snapshot: Channel1 Enabl | Enable

PTZ Activation: Channel1-None | None

Send Email: OFF | Write Log: OFF

Buzzer: OFF | FTP: ON

**Step 3:** Enable the motion detection (in Video Detect or Video Motion). See Chapter 15. Then enable the FTP option.

**Snapshots:** You must also enable snapshot in Video Detect.

**Videos:** You must also enable record in Video Detect and have a storage media in order to upload the videos to FTP. Like many other network cameras, you will need to have a TF card (install inside the camera's built-in memory slot) or a NVR as a forwarding transfer station to your FTP. This is required because without storage media, the camera does not have enough RAM to hold large video files before it establishes a connection with your FTP.

## 17. Cable Waterproof Measures

The camera itself is IP 66 Waterproof Rating. However, the cable connectors may still have exposures to water under different applications. It is always recommended for users to take precautions to protect the cable connectors of the camera.

Below are 3 popular methods:

1. Certain models have waterproof ethernet kit shipped together with the camera. To apply the waterproof kit, you have to cut the crystal head, thread the ethernet cable through the waterproof kit, and then finally use crimper tool to add the crystal head back to the cable.
2. Using electrical waterproof tape is one of the most popular ways of protecting connectors from water exposure.
3. Using waterproof connector protector together with some electrical waterproof tapes can be another option.

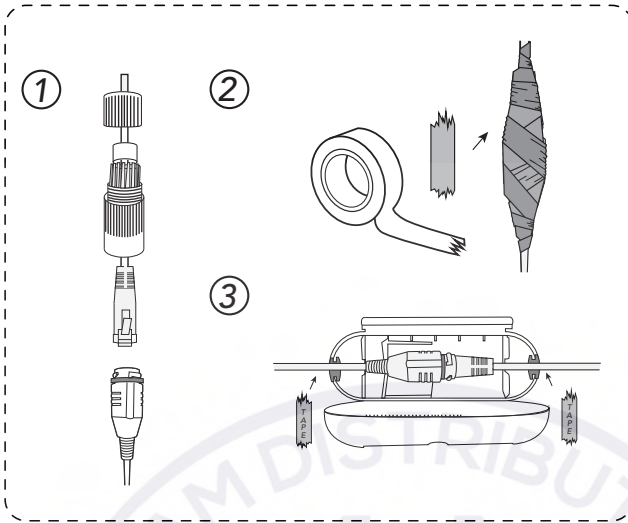

## 18. Audio Setting

Note: The camera has **built-in microphone** with sound pick-up capacity. There is no need to install additional microphone on this model.

Setup: how to enable the audio at camera after installation?

Please remember to check the audio option in "Device Config->Encode->video/audio->Enable it "

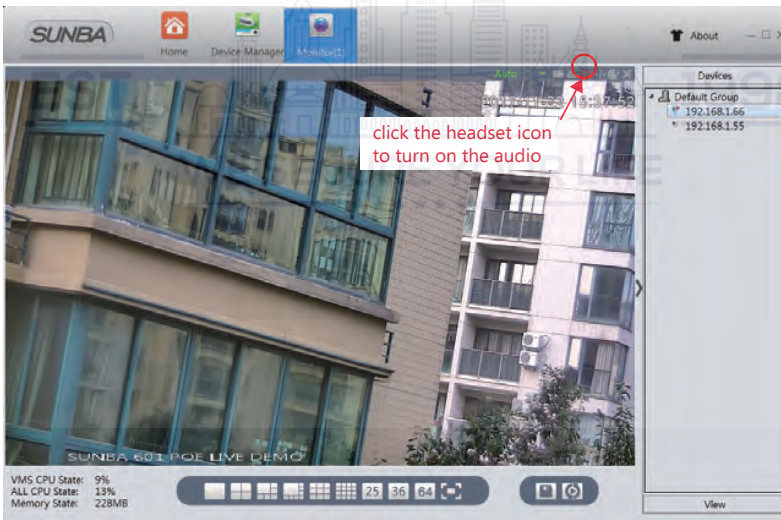

# 19. Auto Tracking Setup

Only applies to 405-ECO V2, 405-D20X 4K V2 and 405-D25X 4K  
(Almost all Lite series in 2024 support automatic tracking)

## 1. Intrusion Tracking

① Go to Device Config > Intelligent Alert, enable Human Detect (Disabled by default).



② Set up intrusion rules.

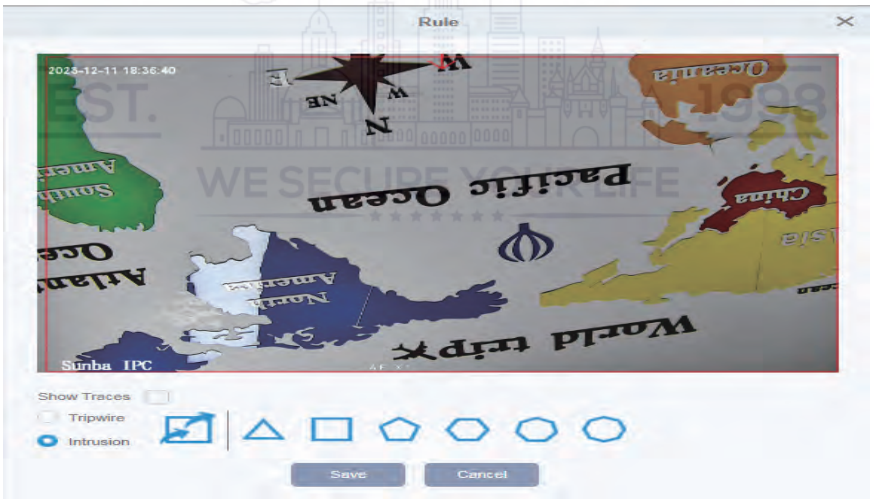

③ Add preset 50 and then call preset 50.

## 2. Line Cross Tracking

- ① Go to Device Config > Intelligent Alert, enable Human Detect (Disabled by default).
- ② Set up line cross rules.



- ③ Add preset 51 and then call preset 51.

## 3. Patrol Tracking

- ① Go to Device Config > Intelligent Alert, enable Human Detect (Disabled by default).
- ② Add presets 53--59, then call preset 53.

97+125+CALL;	Set the Auto Tracking Duration to 15s;
97+126+CALL;	Set the Auto Tracking Duration to 30s; (30s by default)
.....	.....
97+130+CALL	Set the Auto Tracking Duration to 90s;
97+191+CALL	Set the Park Action to Preset 50 Intrusion Tracking
97+192+CALL	Set the Park Action to Preset 51 Line Cross Tracking
97+193+CALL	Set the Park Action to Preset 53 Patrol Tracking

## Warranty Statement

1.This product comes with a 2-year limited warranty in USA (1 year in other regions) and covering parts only. You must pay the labor fee for repair inside the warehouse. However, any parts replacements are always covered and we will be sending you videos & paper instructions on how to fix the unit. Please contact us first within the warranty period to make sure the condition of warranty is met.

2.Our warranty does not extend to any products that are physically damaged or are not under normal operating conditions as a result of misuse or improper installation on the user's end.

## Sunba's Return Policy

### Return Window

Please return your product within 30 days of your receipt. That's the official deadline the return request must be received. Exception applies for items in resellable conditions.

### RMA

We will provide a Returned Merchandise Authorization (RMA) Number for each item that satisfies the return request. Please put your RMA sheet inside the box for reference to expedite the refund process. All products must be returned within 14 days from the RMA issuing date.

### Complete Package Rule

Please return the product with its original packaging, including manuals, brackets and toolkit that come with the unit for a full refund. According to Amazon's restocking fee policy, returns with incomplete/materially different package may enable sellers to charge a restocking fee up to 20% subject to the completeness of the package. Therefore, please make sure you keep the package in good condition in the period of valid return window to avoid any additional charge.

### Refund

If you didn't receive an automatic refund within 10 days of the receipt of your return, it is either the RMA was not attached to the package or the RMA was lost by the warehouse. In this case, please kindly provide us with your tracking number so that we can match the return package and the refund will be manually processed within 24 hours. Please watch your email notifications.

For any questions, don't hesitate to reach [support@sunba.net](mailto:support@sunba.net)  
SUNBA® Technology

