

INSTALLATION BOX

User Manual

SBP-300NB (IVORY)
SBP-300NBW (WHITE)

EST.

1998

WE SECURE YOUR LIFE



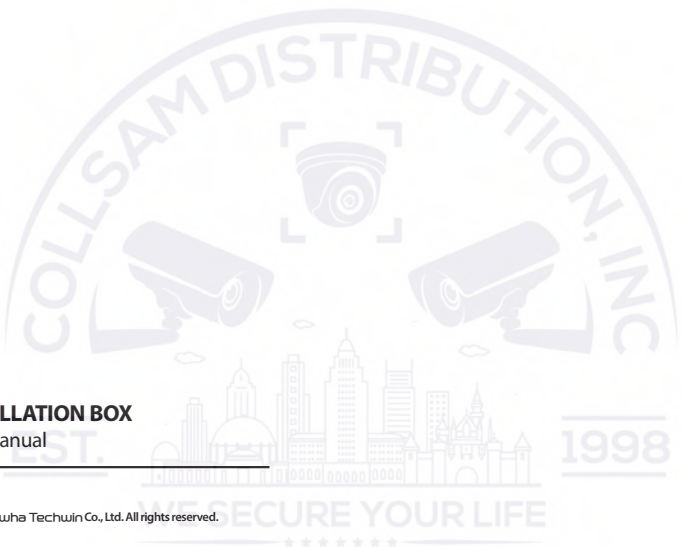

INSTALLATION BOX

User Manual

Copyright

©2019 Hanuha Technin Co., Ltd. All rights reserved.

Trademark

Each of trademarks herein is registered. The name of this product and other trademarks mentioned in this manual are the registered trademark of their respective company.

Restriction

Copyright of this document is reserved. Under no circumstances, this document shall be reproduced, distributed or changed, partially or wholly, without formal authorization.

Disclaimer

Hanuha Technin makes the best to verify the integrity and correctness of the contents in this document, but no formal guarantee shall be provided. Use of this document and the subsequent results shall be entirely on the user's own responsibility. Hanuha Technin reserves the right to change the contents of this document without prior notice.

❖ Design and specifications are subject to change without prior notice.

overview

CONTENTS

OVERVIEW 4 What's Included

3

INSTALLATION & CONNECTION 6 Installation

6

APPENDIX 12 Specification
12 Product Overview

12

EST.



1998







WE SECURE YOUR LIFE



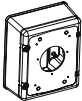







overview

WHAT'S INCLUDED

Please check if your camera and accessories are all included in the product package.

Appearance	Item Name	Quantity
	INSTALLATION BOX	1
	INSTALL BRACKET	1
	Gasket (for SBP-300WM1/WMW1)	1
	Gasket (for SBP-300WM/WMW)	1
	RUBBER HOUSING	1
	BRACKET ADAPTOR	1

Appearance	Item Name	Quantity
	MOUNT CAP	5
	MOUNT CAP fastener	1
	M10 x L22 screw (to attach the install bracket)	4
	M8 x L20 screw (to attach the housing)	4
	M3 x L6 screw (to attach the bracket adaptor and media convert)	4
	M10 x L12 wrench bolt (to attach SBP-300WM/WMW)	4
	M10 x L20 wrench bolt (to attach SBP-300WM1/WMW1)	4
	M4 x L8 screw (to attach the media convert)	2

installation & connection

INSTALLATION

1. Push the locking lever on the door to separate the housing and door.

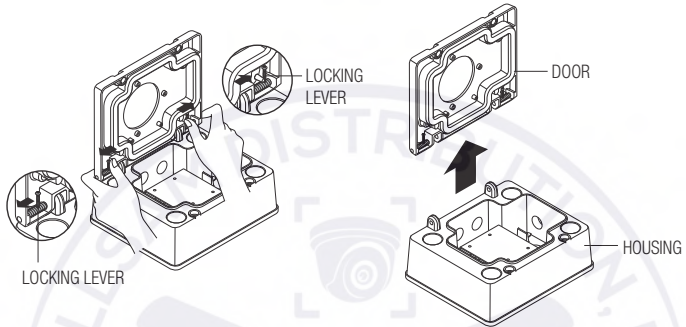

2. Undo the four screws to separate the bracket adaptor. Lock the unused piping hole with the attached mount cap. Use a mount cap fastener to attach the mount cap.

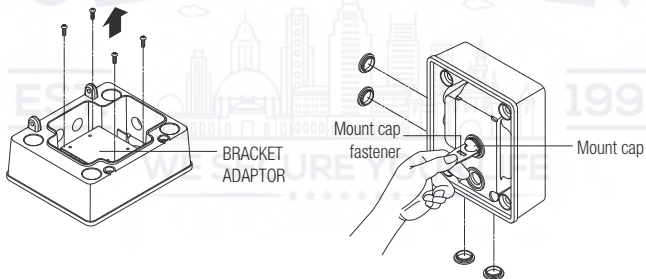

3. Remove the double-sided tap on the rear side of the gasket and affix it to the door. Attach the wall mount to the door using the four M10 screws.
< Tighten each of the four screws a little at a time so that the wall mount is evenly pressed to the gasket. >

- Use of SBP-300WM1/SBP-300WMW1 wall mount (with M10 x L20 screws)

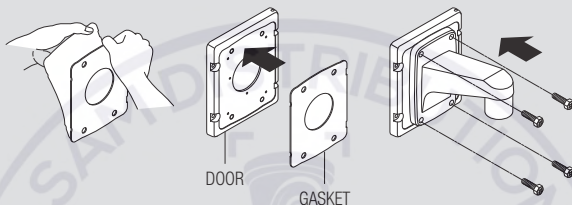

- Use of SBP-300WM/SBP-300WMW wall mount (evenly securing the wall mount inside the gasket groove as shown in the image below.) (with M10 x L12 screws)

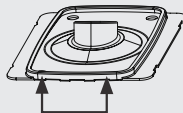
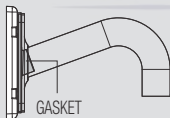
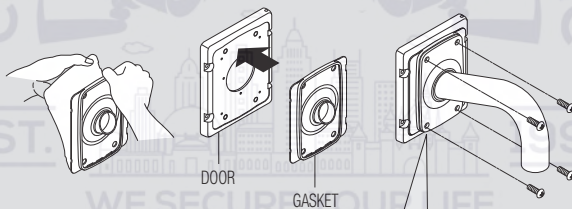

! Please assemble the set in such a way that the lock tab faces down into the slot in the installation direction.

installation & connection

4. Attach the install bracket to the wall, corner mount (SBP-300KM/SBP-300KMW) or pole mount (SBP-300PM/SBP-300PMW) using the M10 screws.

Only use the 4 screws included in the accessories as shown in the image below.



- Installation on the wall

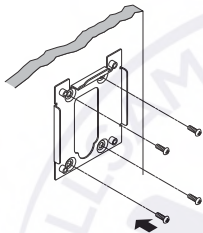

- Corner Mount

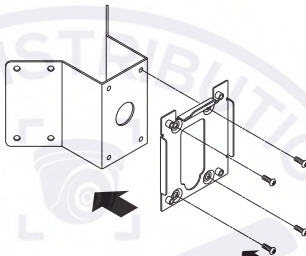

- Pole Mount

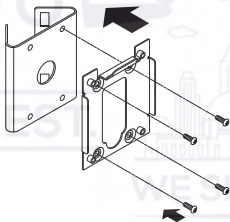

5. Place the housing on the install bracket as shown in the image.

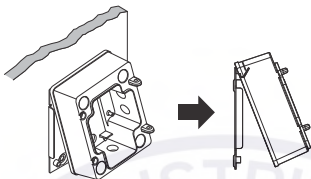

- To install it on the wall, attach the rubber housing as shown in the figure. The rubber is not waterproof. It is decorative only, serving to hide a gap. Therefore, if the cable is inserted into the main body separately and not through the duct on the wall, the insertion point of the cable must be completely waterproof. If this is not done, any water leaks may cause problems.

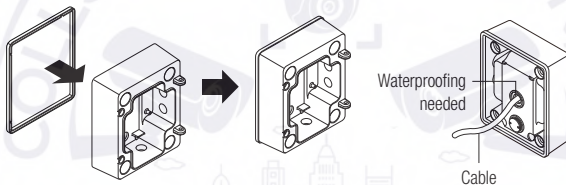

6. Secure the housing to the install bracket using 4 M8 screws in the same ways as "No. 4" in the installation procedure.

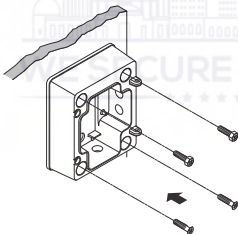

installation & connection

7. Insert the external cable into the main body using a pipe.
Wrap the thread of the pipe screw with Teflon tape to protect against water leakage problems.
(Make sure that water leaks will not cause a problem at the cable insertion point.)

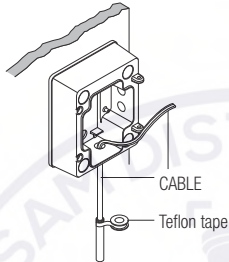

8. Install the power adaptor and media converter using the bracket adaptor, and connect the external cable.

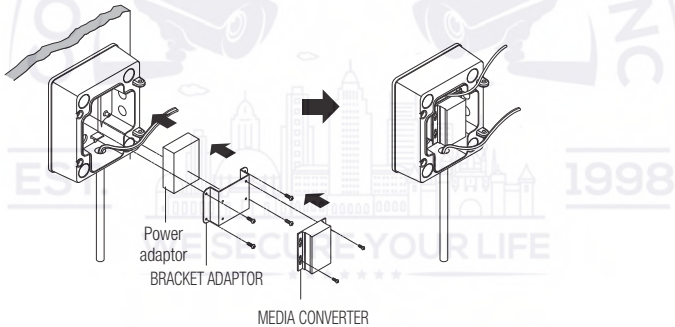

9. Pull the cable out through the door and wall mount and mount the door on the housing.
(Return the locking lever to its original position and check that the hinge is properly attached to the housing.)

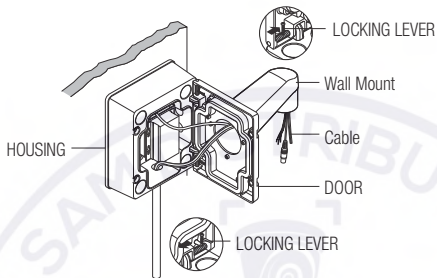

10. Fasten the door to the housing using a hexagonal wrench. (Tighten the screws while pressing the door with your hand as shown in the image below. Then tighten each of the screws a little at a time to make sure that the door is tightly pressed to the housing.)

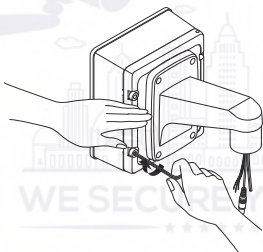

appendix

SPECIFICATION

Items	Description
Dimensions (mm)	W185.0 x D221.0 x H94.3 (mm)
Weight	3.4kg
Material	STEEL, ALUMINUM, SILICON

PRODUCT OVERVIEW

Unit : mm (inch)

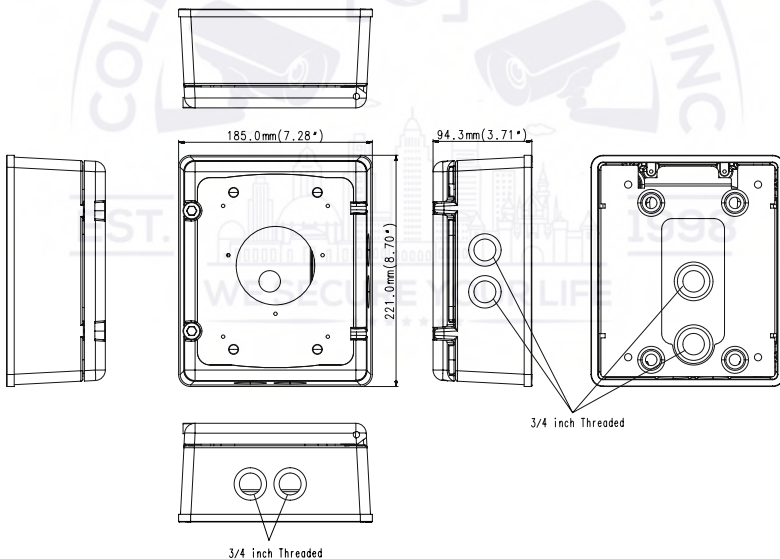

Head Office

6, Pangyo-ro 319 beon-gil, Bundang-gu, Seongnam-si,
Gyeonggi-do, 463-400 Rep. of KOREA
Tel : +82.70.7147.8753 Fax : +82.31.8018.3740
www.hanwha-security.com

Hanwha Techwin America

500 Frank W. Burr Blvd. Suite 43 Teaneck, NJ 07666
Toll Free +1.877.213.1222 Direct +1.201.325.6920
Fax +1.201.373.0124
www.hanwhasecurity.com

Hanwha Techwin Europe

Heriot House, Heriot Road, Chertsey, Surrey, KT16 9DT, United Kingdom
Tel +44.1932.57.8100 Fax +44.1932.57.8101
www.hanwha-security.eu

