



Access Controller

Quick Start Guide

Quick Start Guide

COPYRIGHT ©2018 Hangzhou Hikvision Digital Technology Co., Ltd.

ALL RIGHTS RESERVED.

Any and all information, including, among others, wordings, pictures, graphs are the properties of Hangzhou Hikvision Digital Technology Co., Ltd. or its subsidiaries (hereinafter referred to be “Hikvision”). This user manual (hereinafter referred to be “the Manual”) cannot be reproduced, changed, translated, or distributed, partially or wholly, by any means, without the prior written permission of Hikvision. Unless otherwise stipulated, Hikvision does not make any warranties, guarantees or representations, express or implied, regarding to the Manual.

About this Manual

This Manual is applicable to Access Controller

Product Name	Serials
Access Controller	DS-K2601-G Access Controller
	DS-K2602-G Access Controller
	DS-K2604-G Access Controller

The Manual includes instructions for using and managing the product. Pictures, charts, images and all other information hereinafter are for description and explanation only. The information contained in the Manual is subject to change, without notice, due to firmware updates or other reasons. Please find the latest version in the company website (<http://overseas.hikvision.com/en/>).

Please use this user manual under the guidance of professionals.

Trademarks Acknowledgement

HIKVISION and other Hikvision’s trademarks and logos are the properties of Hikvision in various jurisdictions. Other trademarks and logos mentioned below are the properties of their respective owners.

Legal Disclaimer

TO THE MAXIMUM EXTENT PERMITTED BY APPLICABLE LAW, THE PRODUCT DESCRIBED, WITH ITS HARDWARE, SOFTWARE AND FIRMWARE, IS PROVIDED "AS IS", WITH ALL FAULTS AND ERRORS, AND HIKVISION MAKES NO WARRANTIES, EXPRESS OR IMPLIED, INCLUDING WITHOUT LIMITATION, MERCHANTABILITY, SATISFACTORY QUALITY, FITNESS FOR A PARTICULAR PURPOSE, AND NON-INFRINGEMENT OF THIRD PARTY. IN NO EVENT WILL HIKVISION, ITS DIRECTORS, OFFICERS, EMPLOYEES, OR AGENTS BE LIABLE TO YOU FOR ANY SPECIAL, CONSEQUENTIAL, INCIDENTAL, OR INDIRECT DAMAGES, INCLUDING, AMONG OTHERS, DAMAGES FOR LOSS OF BUSINESS PROFITS, BUSINESS INTERRUPTION, OR LOSS OF DATA OR DOCUMENTATION, IN CONNECTION WITH THE USE OF THIS PRODUCT, EVEN IF HIKVISION HAS BEEN ADVISED OF THE POSSIBILITY OF SUCH DAMAGES.

REGARDING TO THE PRODUCT WITH INTERNET ACCESS, THE USE OF PRODUCT SHALL BE WHOLLY AT YOUR OWN RISKS. HIKVISION SHALL NOT TAKE ANY RESPONSIBILITIES FOR ABNORMAL OPERATION, PRIVACY LEAKAGE OR OTHER DAMAGES RESULTING FROM CYBER ATTACK, HACKER ATTACK, VIRUS INSPECTION, OR OTHER INTERNET SECURITY RISKS; HOWEVER, HIKVISION WILL PROVIDE TIMELY TECHNICAL SUPPORT IF REQUIRED.

SURVEILLANCE LAWS VARY BY JURISDICTION. PLEASE CHECK ALL RELEVANT LAWS IN YOUR JURISDICTION BEFORE USING THIS PRODUCT IN ORDER TO ENSURE THAT YOUR USE CONFORMS THE APPLICABLE LAW. HIKVISION SHALL NOT BE LIABLE IN THE EVENT THAT THIS PRODUCT IS USED WITH ILLEGITIMATE PURPOSES.

IN THE EVENT OF ANY CONFLICTS BETWEEN THIS MANUAL AND THE APPLICABLE LAW, THE LATER PREVAILS.

Regulatory Information

FCC Information

Please take attention that changes or modification not expressly approved by the party responsible for compliance could void the user's authority to operate the equipment.

FCC compliance: This equipment has been tested and found to comply with the limits for a Class B digital device, pursuant to part 15 of the FCC Rules. These limits are designed to provide reasonable protection against harmful interference in a residential installation. This equipment generates, uses and can radiate radio frequency energy and, if not installed and used in accordance with the instructions, may cause harmful interference to radio communications. However, there is no guarantee that interference will not occur in a particular installation. If this equipment does cause harmful interference to radio or television reception, which can be determined by turning the equipment off and on, the user is encouraged to try to correct the interference by one or more of the following measures:

- Reorient or relocate the receiving antenna.
- Increase the separation between the equipment and receiver.
- Connect the equipment into an outlet on a circuit different from that to which the receiver is connected.
- Consult the dealer or an experienced radio/TV technician for help.

FCC Conditions

This device complies with part 15 of the FCC Rules. Operation is subject to the following two conditions:

1. This device may not cause harmful interference.
2. This device must accept any interference received, including interference that may cause undesired operation.

EU Conformity Statement



This product and - if applicable - the supplied accessories too are marked with "CE" and comply therefore with the applicable harmonized European standards listed under the R&TTE Directive 1999/5/EC, the EMC Directive 2014/30/EU, the LVD Directive 2014/35/EU, the RoHS Directive 2011/65/EU.



2012/19/EU (WEEE directive): Products marked with this symbol cannot be disposed of as unsorted municipal waste in the European Union. For proper recycling, return this product to your local supplier upon the purchase of equivalent new equipment, or dispose of it at designated collection points. For more information see:

www.recyclethis.info.



2006/66/EC (battery directive): This product contains a battery that cannot be disposed of as unsorted municipal waste in the European Union. See the product documentation for specific battery information. The battery is marked with this symbol, which may include lettering to indicate cadmium (Cd), lead (Pb), or mercury (Hg).

For proper recycling, return the battery to your supplier or to a designated collection point.

For more information see: www.recyclethis.info.

Industry Canada ICES-003 Compliance

This device meets the CAN ICES-3 (B)/NMB-3(B) standards requirements.

UL294 Level



Feature	Level I
Destructive attack	No attack test
Line security	No line security
Endurance	1000 cycles
Standby power	No secondary power source

Preventive and Cautionary Tips

Before connecting and operating your device, please be advised of the following tips:

- Ensure unit is installed in a well-ventilated, dust-free environment.
- Keep all liquids away from the device.
- Ensure environmental conditions meet factory specifications.
- Ensure unit is properly secured to a rack or shelf. Major shocks or jolts to the unit as a result of dropping it may cause damage to the sensitive electronics within the unit.
- Use the device in conjunction with an UPS if possible.
- Power down the unit before connecting and disconnecting accessories and peripherals.
- A factory recommended HDD should be used for this device.
- Improper use or replacement of the battery may result in hazard of explosion. Replace with the same or equivalent type only. Dispose of used batteries according to the instructions provided by the manufacturer.

Safety Information

	
Warnings Follow these safeguards to prevent serious injury or death.	Cautions Follow these precautions to prevent potential injury or material damage.



Warnings

- All the electronic operation should be strictly compliance with the electrical safety regulations, fire prevention regulations and other related regulations in your local region.
- Knockout shall be either not used or enclosed with the metal conduit.
- Please use the power adapter, which is provided by normal company. The power consumption cannot be less than the required value.

- Do not connect several devices to one power adapter as adapter overload may cause over-heat or fire hazard.
- Please make sure that the power has been disconnected before you wire, install or dismantle the device.
- When the product is installed on wall or ceiling, the device shall be firmly fixed.
- If smoke, odors or noise rise from the device, turn off the power at once and unplug the power cable, and then please contact the service center.
- If the product does not work properly, please contact your dealer or the nearest service center. Never attempt to disassemble the device yourself. (We shall not assume any responsibility for problems caused by unauthorized repair or maintenance.)



Cautions

- Do not drop the device or subject it to physical shock, and do not expose it to high electromagnetism radiation. Avoid the equipment installation on vibrations surface or places subject to shock (ignorance can cause equipment damage).
- Do not place the device in extremely hot (refer to the specification of the device for the detailed operating temperature), cold, dusty or damp locations, and do not expose it to high electromagnetic radiation.
- The device cover for indoor use shall be kept from rain and moisture.
- Exposing the equipment to direct sun light, low ventilation or heat source such as heater or radiator is forbidden (ignorance can cause fire danger).
- Do not aim the device at the sun or extra bright places. A blooming or smear may occur otherwise (which is not a malfunction however), and affecting the endurance of sensor at the same time.
- Please use the provided glove when open up the device cover, avoid direct contact with the device cover, because the acidic sweat of the fingers may erode the surface coating of the device cover.
- Please use a soft and dry cloth when clean inside and outside surfaces of the device cover, do not use alkaline detergents.
- Please keep all wrappers after unpack them for future use. In case of any failure occurred, you need to return the device to the factory with the original wrapper. Transportation without the original wrapper may result in damage on the device and lead to additional costs.
- Improper use or replacement of the battery may result in hazard of explosion. Replace with the same or equivalent type only. Dispose of used batteries according to the instructions provided by the battery manufacturer.

Table of Contents

1 Product Description	3
1.1 Overview.....	3
1.2 Main Feature	3
2 Appearance	5
3 Terminal Connection.....	7
3.1 Terminals Description	8
3.1.1 DS-K2601-G Terminal Description	8
3.1.2 DS-K2602-G Terminal Description	12
3.1.3 DS-K2604-G Terminal Description	17
3.2 Card Reader Installation	23
3.2.1 External Terminal	23
3.2.2 Card Reader Installation	24
3.3 Installing E-Lock	26
3.3.1 Installation of Cathode Lock.....	26
3.3.2 Installation of Anode Lock.....	26
3.4 Connecting the External Alarm Device	27
3.5 Door Button Wiring Diagram	27
3.6 The Connection of Magnetics Detection	28
3.7 Connecting Power Supply	28
3.8 Arming Region Input Terminal	29
3.8.1 Connecting Normally Open Detector	29
3.8.2 Connecting Normally Closed Detector	29
3.9 Fire Alarm Module Wiring	30
4 Settings	31
4.1 Initializing the Hardware.....	31
4.2 Relay Input NO/NC	31
4.2.1 Lock Relay Output	31

4.2.2 Alarm Relay Output Status 32

5 Activating Device 37

5.1 Activation via SADP Software 37

5.2 Activation via Client Software 39

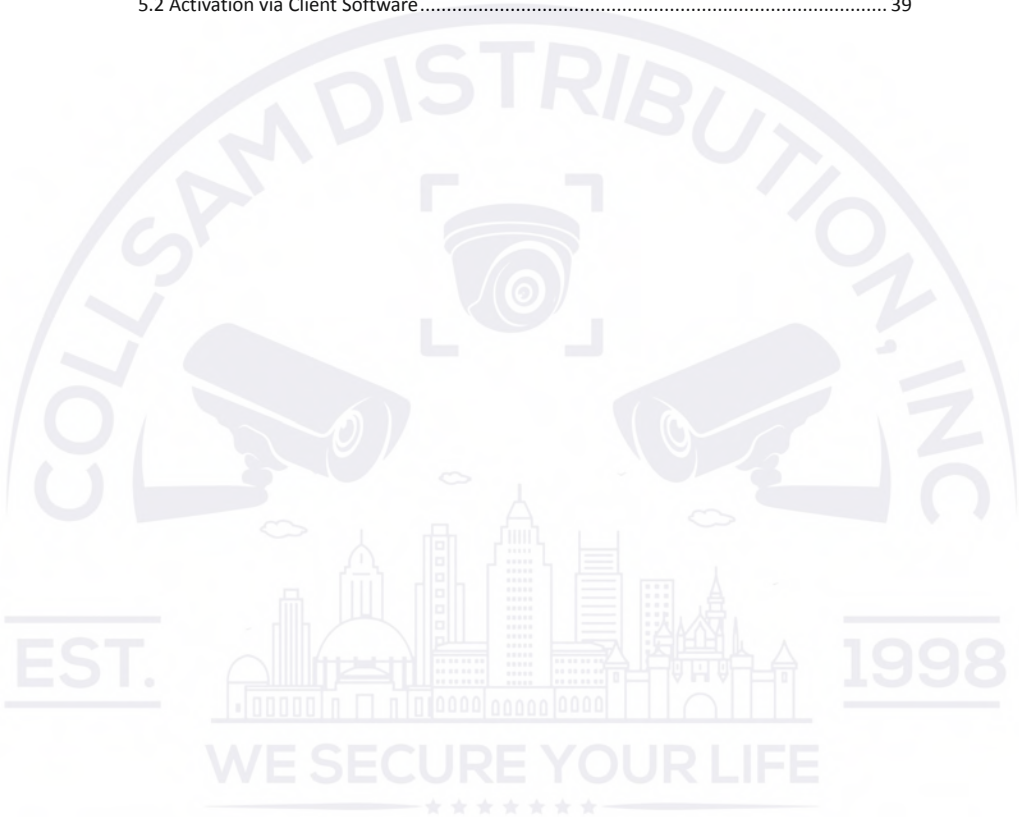

1 Product Description

1.1 Overview

DS-K2600 is a powerful and stable access controller, using the logical architecture design. DS-K2600 is designed with TCP/IP network interface and its signal processed with special encryption and can be run offline. Tamper-proof function is also supported.

1.2 Main Feature

- The access controller is equipped with 32-bit high-speed processor
- Supports TCP/IP and GPRS network communication, EHome accessing. The communication data is specially encrypted to relieve the concern of privacy leak
- Support recognition and storage of card number with maximum length of 20
- The access controller can store 100 thousand legal cards (97 thousand normal cards and 3 thousand visitor cards) and 300 thousand card swiping records
- Supports multi-door interlock function, anti-passback function, multi-card function, first card open function, super card and super password function, M1 card encryption, online upgrade function and remote control of the doors
- Supports tamper-proof alarm for card reader, alarm for door not secured, force opening door alarm, alarm for door opening timeout, duress card and code alarm, blacklist alarm and alarm for illegal card swiping attempts reaching the limit
- The alarm input of controller supports short circuit protection function and cut-proof function
- Multiple event upload methods: channel, center group, and listening
- 50 event and card linkages
- IP address conflict detection
- Cross-controller anti-passing back function (For cross-controller anti-passing back based on card, wire the card reader with RS-485. For cross-controller anti-passing back based on network, connect the server and device properly. Up to 5000 cards' swiping records can be stored in the selected server.) and inner-device anti-pass-back function

- Supports RS-485 interface and Wiegand interface for accessing card reader. RS485 interface adopts dual-interface design and supports loop breakpoint detection and redundancy function; Wiegand interface supports W26, W34 and is seamlessly compatible with third-party card reader with Wiegand interface
- Supports various card types as normal/ disabled/ blacklist/ patrol/ guest/ duress/ super card, etc.
- Various indicators to show different status
- Supports time synchronization via NTP, manual or automatic method
- Supports record storage function when it is offline and insufficient storage space storage alarm function
- The access controller has backup battery design, watchdog design and tamper-proof function
- Data can be permanently saved after the access controller is powered off.
- Supports I/O linkage, and event linkage
- Supports EHome protocol, and inter-network communication
- 500 groups of password under the authentication mode of card and password

EST.



1998

WE SECURE YOUR LIFE



2 Appearance

Take DS-K2604-G as an example, the component schematic diagram is shown below.

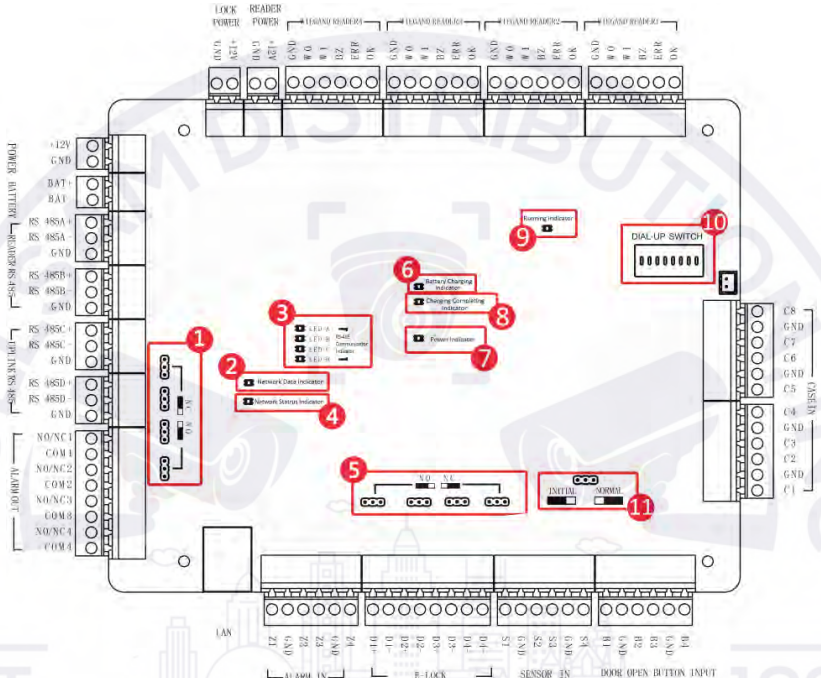

Figure 2-1 DS-K2604-G Component Schematic Diagram

Table 2-1 DS-K2600 Component Description

No.	Component Description		
	DS-K2601-G	DS-K2602-G	DS-K2604-G
1	Alarm Relay Output Status (NC/NO)		
2	Network Data Indicator		
3	RS-485 Communication Indicator		
4	Network Status Indicator		
5	Door Relay Output Status (NC/NO) Choice		
6	Battery Charging Indicator		
7	Power Indicator		
8	Charging Completing Indicator		
9	Running Indicator		
10	Hardware Initialization and Normal Working Choice		
11	Main board dial-up switch/ Reserved		

3 Terminal Connection

Notes:

- The wire diameter of the Wiegand, RS-485, arming region, alarm input, and alarm output should be no less than 26 AWG (0.128 mm²). And the power cord's diameter of the door lock should be no less than 18 AWG (0.810 mm²).
- The wiring methods shall be in accordance with the National Electrical Code, ANSI/NFPA 70 reference to NFPA 70.
- Power cord type: Detachable, type SVT or SPT-2, 18 AWG min., min. length 1.5m, max. length 4.5 m. One end with NEMA 5-15P. Other end with appliance coupler.

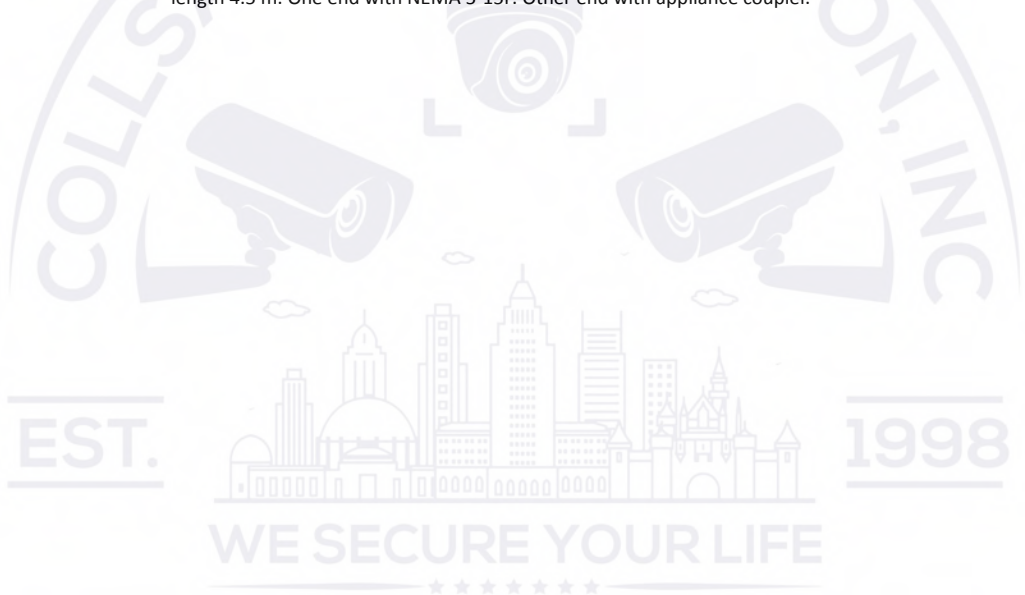

Table 3-1 DS-K2601-G Terminal Description

No.	DS-K2601-G		
A1	Lock Power	GND	Grounding
A2		+12V	Power Output of the Lock
A3	Card Reader Power	GND	Grounding
A4		+12V	Power Output of the Head Read
A5	Wiegand Card Reader 2	GND	Grounding
A6		W0	Wiegand Head Read Data Input Data0
A7		W1	Wiegand Head Read Data Input Data1
A8		BZ	Card Reader Buzzer Control Output
A9		ERR	Indicator of Card Reader Control Output (Invalid Card Output)
A10		OK	Indicator of Card Reader Control Output (Valid Card Output)
A11	Wiegand Card Reader 1	GND	Grounding
A12		W0	Wiegand Head Read Data Input Data0
A13		W1	Wiegand Head Read Data Input Data1
A14		BZ	Card Reader Buzzer Control Output
A15		ERR	Indicator of Card Reader Control Output (Invalid Card Output)
A16		OK	Indicator of Card Reader Control Output (Valid Card Output)
B1	Arming Region	Z1	Arming Region Access Terminal 1 (Only for Linkage of Alarm Relay Output)
B2	Input	GND	Grounding

DS-K2600 Series Access Controller

No.	DS-K2601-G		
B3		Z2	Arming Region Access Terminal 2 (Only for Linkage of Alarm Relay Output)
B4		Z3	Arming Region Access Terminal 3 (Only for Linkage of Alarm Relay Output)
B5		GND	Grounding
B6		Z4	Arming Region Access Terminal 4 (Only for Linkage of Alarm Relay Output)
B7	E-Lock	D1+	Door 1 Door Relay Input (Dry Contact)
B8		D1-	
B9	Door Contact Input	S1	Door 1 Door Contact Detector Input
B10		GND	Grounding
B11	Door Open Button	B1	Door 1 Door Open Button Input
B12		GND	Grounding
C1	Power	+12V	DC12V Cathode
C2		GND	DC12V Grounding Input
C3	Battery	BAT+	DC12V Battery Cathode
C4		BAT-	DC12V Battery Anode
C5	485 Card Reader	RS 485A+	Card Reader RS485+ Access
C6		RS 485A-	Card Reader RS485- Access
C7		GND	Grounding
C8		RS 485B+	Card Reader RS485+
C9		RS 485B-	Card Reader RS485-

DS-K2600 Series Access Controller

No.	DS-K2601-G		
C10		GND	Grounding
C11	Access Controller RS485 Interface	RS 485C+	Uplink RS485+Communication
C12		RS 485C-	Uplink RS485-Communication
C13		GND	Grounding
C14		RS 485D+	Reserved
C15		RS 485D-	
C16		GND	
C17	Alarm Output	NO/NC1	Alarm Relay 1 Output (Dry Contact)
C18		COM1	
C19		NO/NC2	Alarm Relay 2 Output (Dry Contact)
C20		COM2	
D1	Event Input	C2	Event Alarm Input 2
D2		GND	Grounding
D3		C1	Event Alarm Input 1

Table 3-2 DS-K2602-G Terminal Description

No.	DS-K2602-G		
A1	Power for	GND	Grounding
A2	E-Lock	+12V	Power Output of the Lock
A3	Power for	GND	Grounding
A4	Card Reader	+12V	Power Output of the Head Read
A5	Wiegand Card Reader 4	GND	Grounding
A6		W0	Wiegand Head Read Data Input Data0
A7		W1	Wiegand Head Read Data Input Data1
A8		BZ	Card Reader Buzzer Control Output
A9		ERR	Indicator of Card Reader Control Output (Invalid Card Output)
A10		OK	Indicator of Card Reader Control Output (Valid Card Output)
A11	Wiegand Card Reader 3	GND	Grounding
A12		W0	Wiegand Head Read Data Input Data0
A13		W1	Wiegand Head Read Data Input Data1
A14		BZ	Card Reader Buzzer Control Output
A15		ERR	Indicator of Card Reader Control Output (Invalid Card Output)
A16		OK	Indicator of Card Reader Control Output (Valid Card Output)
A17	Wiegand	GND	Grounding
A18	Card Reader	W0	Wiegand Head Read Data Input Data0

No.	DS-K2602-G		
A19	2	W1	Wiegand Head Read Data Input Data1
A20		BZ	Card Reader Buzzer Control Output
A21		ERR	Indicator of Card Reader Control Output (Invalid Card Output)
A22		OK	Indicator of Card Reader Control Output (Valid Card Output)
A23	Wiegand Card Reader 1	GND	Grounding
A24		W0	Wiegand Head Read Data Input Data0
A25		W1	Wiegand Head Read Data Input Data1
A26		BZ	Card Reader Buzzer Control Output
A27		ERR	Indicator of Card Reader Control Output (Invalid Card Output)
A28		OK	Indicator of Card Reader Control Output (Valid Card Output)
B1	Arming Region	Z1	Arming Region Access Terminal 1 (Only for Linkage of Alarm Relay Output)
B2		GND	Grounding
B3		Z2	Arming Region Access Terminal 2 (Only for Linkage of Alarm Relay Output)
B4		Z3	Arming Region Access Terminal 3 (Only for Linkage of Alarm Relay Output)
B5		GND	Grounding
B6		Z4	Arming Region Access Terminal 4 (Only for Linkage of Alarm Relay Output)
B7		E-Lock1	D1+

No.	DS-K2602-G		
B8		D1-	
B9	E-Lock2	D2+	Door 2 Door Relay Input (Dry Contact)
B10		D2-	
B11	Door	S1	Door 1 Magnetic Detector Input
B12	Magnetics Detector	GND	Signal Grounding
B13		S2	Door 2 Magnetic Detector Input
B14	Door Button	B1	Door 1 Door Button Input
B15		GND	Signal Grounding
B16		B2	Door 2 Door Button Input
C1	Power	+12V	DC12V Cathode
C2		GND	Grounding
C3	Battery	BAT+	DC12V Battery Cathode
C4		BAT-	DC12V Battery Anode
C5	Card Reader 485 Interface	RS 485A+	Card Reader RS485+ Access
C6		RS 485A-	Card Reader RS485- Access
C7		GND	Grounding
C8		RS 485B+	Card Reader RS485+
C9		RS 485B-	Card Reader RS485-
C10		GND	Grounding
C11	RS-485 Interface	RS 485C+	Uplink RS485+Communication
C12		RS 485C-	Uplink RS485-Communication

No.	DS-K2602-G		
C13		GND	Grounding
C14		RS 485D+	Reserved
C15		RS 485D-	
C16		GND	
C17	Alarm Output	NO/NC1	Alarm Relay 1 Output (Dry Contact)
C18		COM1	
C19		NO/NC2	Alarm Relay 2 Output (Dry Contact)
C20		COM2	
C21		NO/NC3	Alarm Relay 3 Output (Dry Contact)
C22		COM3	
C23		NO/NC4	Alarm Relay 4 Output (Dry Contact)
C24		COM4	
D1	Event Input	C4	Event Alarm Input 4
D2		GND	Grounding
D3		C3	Event Alarm Input3
D4		C2	Event Alarm Input 2
D5		GND	Grounding
D6		C1	Event Alarm Input 1

3.1.3 DS-K2604-G Terminal Description

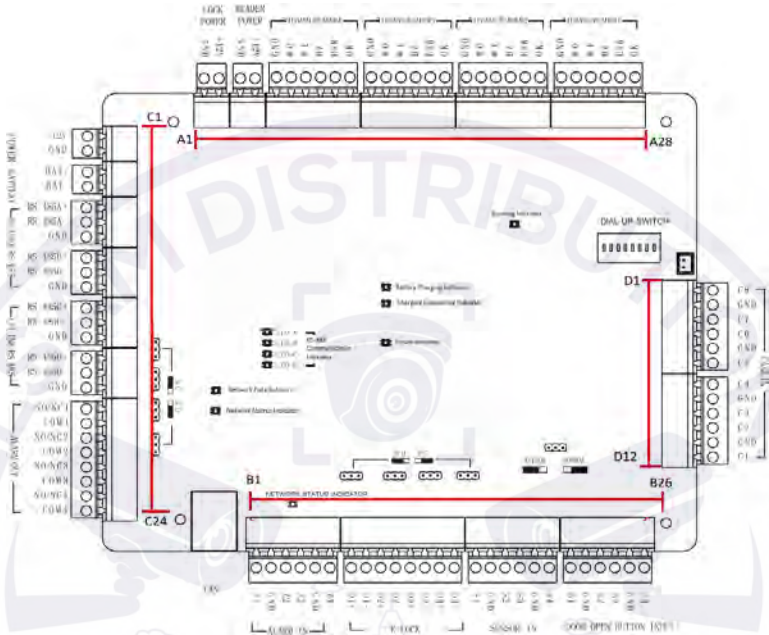

Figure 3-3 DS-K2604-G Access Controller Terminals

Table 3-3 DS-K2604-G Terminal Description

No.	DS-K2604-G		
A1	Power	GND	Grounding
A2	Supply of E-Lock	+12V	Power Supply of E-Lock Output
A3	Power	GND	Grounding
A4	Supply of Card Reader	+12V	Power Supply of Card Reader Output

No.	DS-K2604-G		
A5	Wiegand Card Reader 4	GND	Grounding
A6		W0	Wiegand Card Reader Data Input Data0
A7		W1	Wiegand Card Reader Data Input Data1
A8		BZ	Buzzer of Card Reader Control Output
A9		ERR	Cresset of Card Reader Control Output (Invalid Card Output)
A10		OK	Cresset of Card Reader Control Output (Valid Card Output)
A11	Wiegand Card Reader 3	GND	Grounding
A12		W0	Wiegand Card Reader Data Input Data0
A13		W1	Wiegand Card Reader Data Input Data1
A14		BZ	Buzzer of Card Reader Control Output
A15		ERR	Cresset of Card Reader Control Output (Invalid Card Output)
A16		OK	Cresset of Card Reader Control Output (Valid Card Output)
A17	Wiegand Card Reader 2	GND	Grounding
A18		W0	Wiegand Card Reader Data Input Data0
A19		W1	Wiegand Card Reader Data Input Data1
A20		BZ	Buzzer of Card Reader Control Output
A21		ERR	Cresset of Card Reader Control Output (Invalid Card Output)
A22		OK	Cresset of Card Reader Control Output (Valid Card Output)

No.	DS-K2604-G		
A23	Wiegand Card Reader 1	GND	Grounding
A24		W0	Wiegand Card Reader Data Input Data0
A25		W1	Wiegand Card Reader Data Input Data1
A26		BZ	Buzzer of Card Reader Control Output
A27		ERR	Cresset of Card Reader Control Output (Invalid Card Output)
A28		OK	Cresset of Card Reader Control Output (Valid Card Output)
B1	Arming Region Input	Z1	Arming Region Access Terminal 1 (Only for Linkage of Alarm Relay Output)
B2		GND	Grounding
B3		Z2	Arming Region Access Terminal 2 (Only for Linkage of Alarm Relay Output)
B4		Z3	Arming Region Access Terminal 3 (Only for Linkage of Alarm Relay Output)
B5		GND	Grounding
B6		Z4	Arming Region Access Terminal 4 (Only for Linkage of Alarm Relay Output)
B7	E-Lock 1	D1+	Door 1 Door Relay Input (Dry Contact)
B8		D1-	
B9	E-Lock 2	D2+	Door 2 Door Relay Input (Dry Contact)
B10		D2-	
B11	E-Lock 3	D3+	Door 3 Door Relay Input (Dry Contact)

No.	DS-K2604-G		
B12		D3-	
B13	E-Lock 4	D4+	Door 4 Door Relay Input (Dry Contact)
B14		D4-	
B15	Door Magnetics Input	S1	Door 1 Magnetic Detector Input
B16		GND	Signal Grounding
B17		S2	Door 2 Magnetic Detector Input
B18		S3	Door 3 Magnetic Detector Input
B19		GND	Signal Grounding
B20		S4	Door 4 Magnetic Detector Input
B21	Door Button	B1	Door 1 Door Button Input
B22		GND	Signal Grounding
B23		B2	Door 2 Door Button Input
B24		B3	Door 3 Door Button Input
B25		GND	Signal Grounding
B26		B4	Door 4 Door Button Input
C1	Power	+12V	DC12V Cathode
C2		GND	Grounding
C3	Battery	BAT+	DC12V Battery Cathode
C4		BAT-	DC12V Battery Anode
C5	Card Reader	RS 485A+	Card Reader RS485A+
C6		RS 485A-	Card Reader RS485A-
C7		GND	Grounding

No.	DS-K2604-G			
C8		RS 485B+	Card Reader RS485B+	
C9		RS 485B-	Card Reader RS485B-	
C10		GND	Grounding	
C11	Access Controller RS485	RS 485C+	Uplink RS485+Communication	
C12		RS 485C-	Uplink RS485-Communication	
C13		GND	Grounding	
C14		RS 485D+	Reserved	
C15		RS 485D-		
C16		GND		
C17	Alarm Output	NO/NC1	Alarm Relay 1 Output (Dry Contact)	
C18		COM1		
C19		NO/NC2	Alarm Relay 2 Output (Dry Contact)	
C20		COM2		
C21		NO/NC3	Alarm Relay 3 Output (Dry Contact)	
C22		COM3		
C23		NO/NC4	Alarm Relay 4 Output (Dry Contact)	
C24		COM4		
D1	Event Input	C8	Event Alarm Input 8	
D2		GND	Grounding	
D3		C7	Event Alarm Input 7	
D4		C6	Event Alarm Input 6	
D5		GND		Grounding

No.	DS-K2604-G	
D6	C5	Event Alarm Input 5
D7	C4	Event Alarm Input 4
D8	GND	Grounding
D9	C3	Event Alarm Input3
D10	C2	Event Alarm Input 2
D11	GND	Grounding
D12	C1	Event Alarm Input 1

Notes:

- The alarm input hardware interface is normally open by default. So only the normally open signal is allowed. It can be linked to the buzzer of the card reader and access controller, and the alarm relay output and open door relay output.
- Arming region alarm input is only for the alarm relay output linkage.
- RS485 card ID should be set as 1 to 8. For example, the ID of door 1 is 1 and 2 standing for in and out respectively.
- For single-door access controller, the Wiegand card reader 1 and 2 respectively correspond to the entering and exiting card readers of door 1. For two-door access controller, the Wiegand card reader 1 and 2 respectively correspond to the entering and exiting card readers of door 1, and the Wiegand card reader 3 and 4 respectively correspond to the entering and exiting card readers of door 2. For single-door access controller, the Wiegand card reader 1, 2, 3 and 4 respectively correspond to the entering card readers of door 1, 2, 3, and 4.

3.2 Card Reader Installation

3.2.1 External Terminal

DS-K2601-G External Terminals

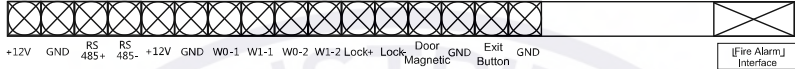

Figure 3-4 DS-K2601-G External Terminals

DS-K2602-G External Terminals

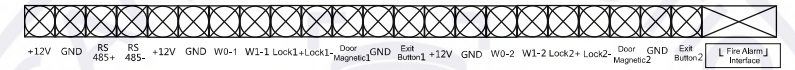

Figure 3-5 DS-K2602-G External Terminals

DS-K2604-G External Terminals



Figure 3-6 DS-K2604-G External Terminals

3.2.2 Card Reader Installation

The Connection of Wiegand Card Reader

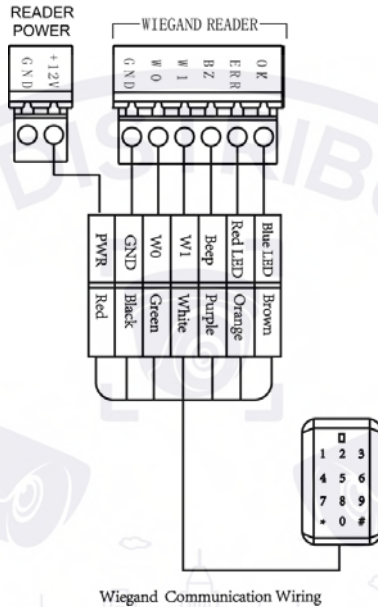

Figure 3-7 Wiring diagram of Wiegand card reader

Note: You must connect the OK/ERR/BZ, if using access controller to control the LED and buzzer of the Wiegand card reader.

RS-485 Card Reader Connection

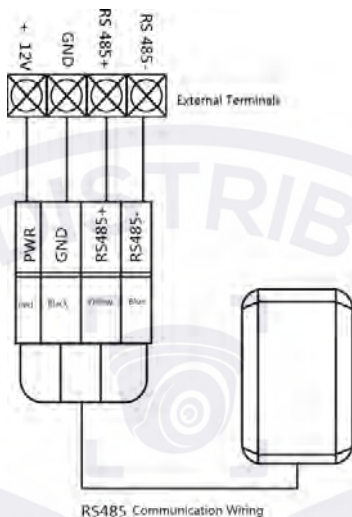

Figure 3-8 Wiring diagram of RS-485

Note: If the card reader is installed too far away from the access controller, you can use an external power supply.

3.3 Installing E-Lock

3.3.1 Installation of Cathode Lock

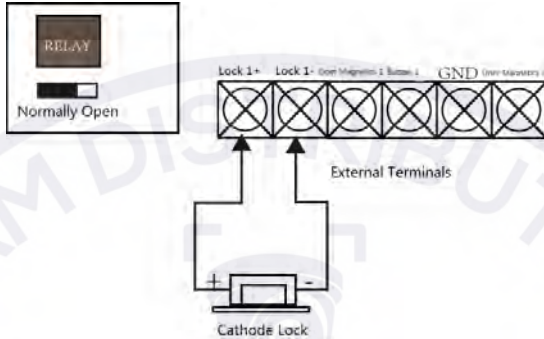

Figure 3-9 Wiring diagram of cathode lock

3.3.2 Installation of Anode Lock

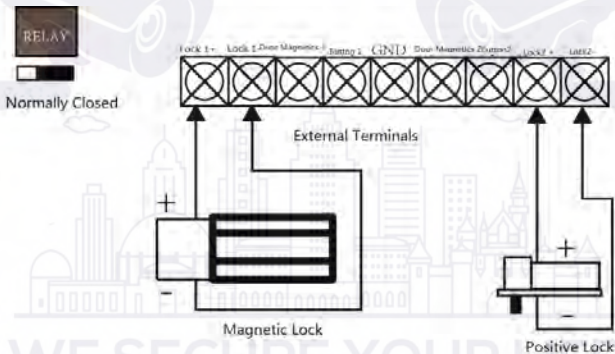

Figure 3-10 Wiring diagram of anode lock

3.4 Connecting the External Alarm Device

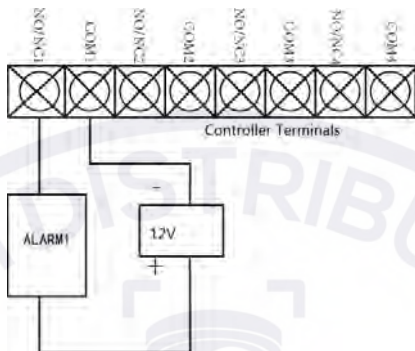

Figure 3-11 External Alarm Device Connection

3.5 Door Button Wiring Diagram

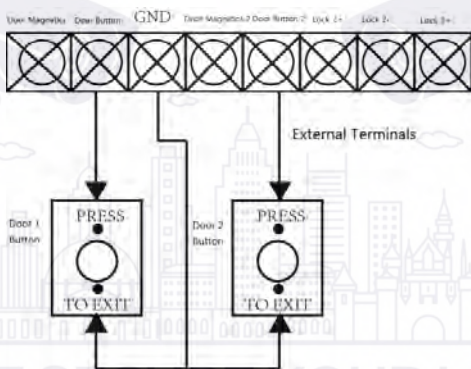

Figure 3-12 Power Button Connection

3.6 The Connection of Magnetics Detection

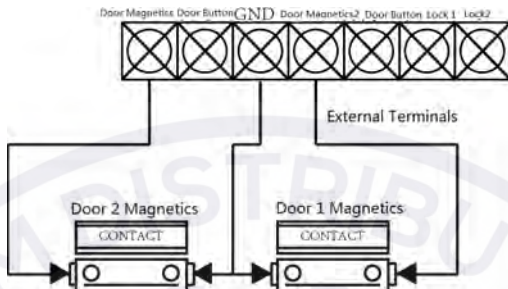

Figure 3-13 Magnetics Connection

3.7 Connecting Power Supply

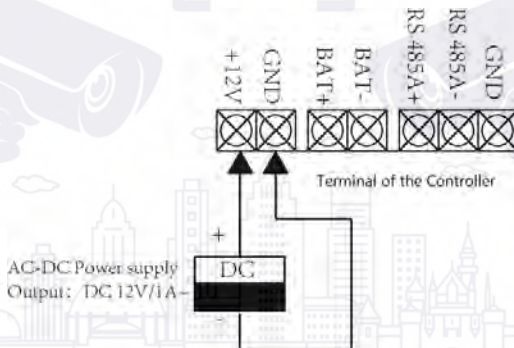

Figure 3-14 Power Supply Connection

3.8 Arming Region Input Terminal

3.8.1 Connecting Normally Open Detector

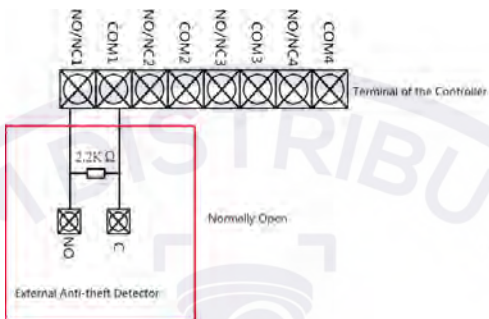

Figure 3-15 Normally Open Status

3.8.2 Connecting Normally Closed Detector

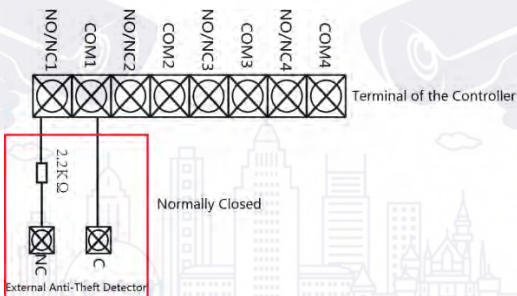

Figure 3-16 Normally Closed Status

3.9 Fire Alarm Module Wiring

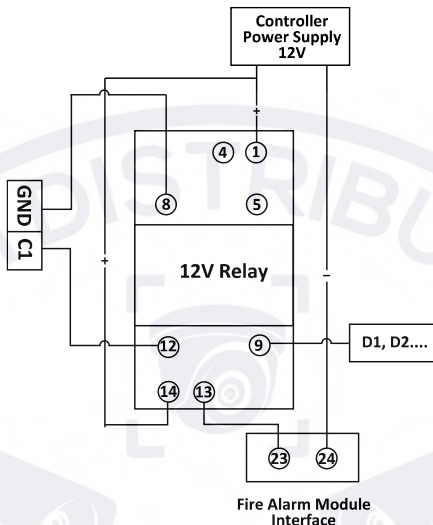

Figure 3-17 Fire Alarm Module Wiring



4 Settings

4.1 Initializing the Hardware

Option 1:

Steps:

1. Remove the jumper cap from the Normal terminal.
2. Disconnect the power and restart the access controller. The controller buzzer buzzes a long beep.
3. When the beep stopped, plug the jumper cap back to Normal.

Option 2:

Steps:

1. Jump the jumper cap from Normal to Initial.
2. Disconnect the power and restart the access controller. The controller buzzer buzzes a long beep.
3. When the beep stopped, jump the jumper cap back to Normal.

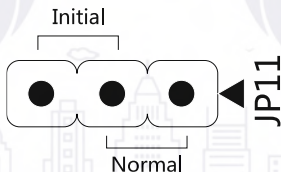

Figure 4-1 Initialization Dial-up

Note: The initializing of the hardware will restore all the parameters to the default settings and all the device events are wiping out.

4.2 Relay Input NO/NC

4.2.1 Lock Relay Output

Lock Relay Normally Open Status

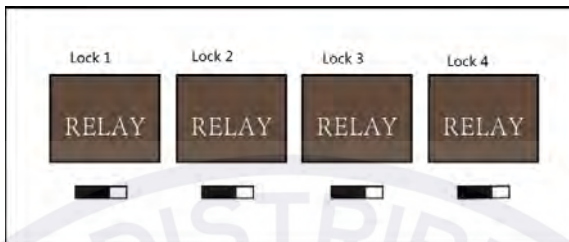

Figure 4-2 Normally Open Status

Lock Relay Normally Closed Status



Figure 4-3 Normally Closed Status

4.2.2 Alarm Relay Output Status

Alarm Relay Output Normally Open

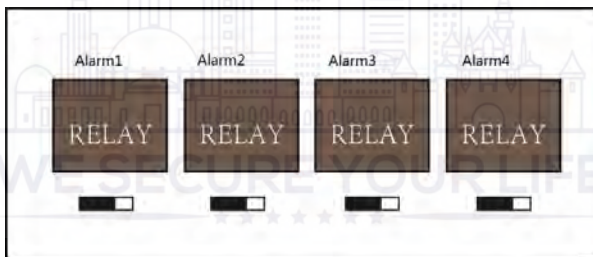

Figure 4-4 Alarm Relay Output Normally Open

Alarm Relay Output Normally Closed



Figure 4-5 Normally Closed Status

Work Flow of Software

For detailed information, see the user manual of the client software.

Refer to the following work flow:

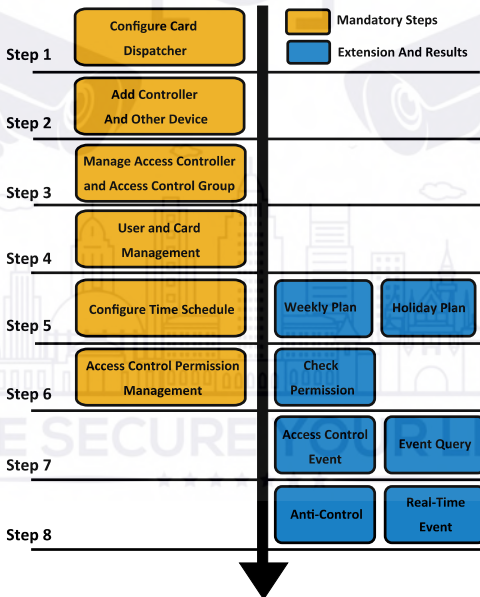

Figure 4-6 Software Client Work Flow

5 Activating Device

Purpose:

You are required to activate the control panel first before you can use the control panel.

Activation via SADP, and Activation via client software are supported.

5.1 Activation via SADP Software

SADP software is used for detecting the online device, activating the device, and resetting the password.

Get the SADP software from the supplied disk or the official website, and install the SADP according to the prompts. Follow the steps to activate the control panel.

Steps:

1. Run the SADP software to search the online devices.
2. Check the device status from the device list, and select an inactive device.

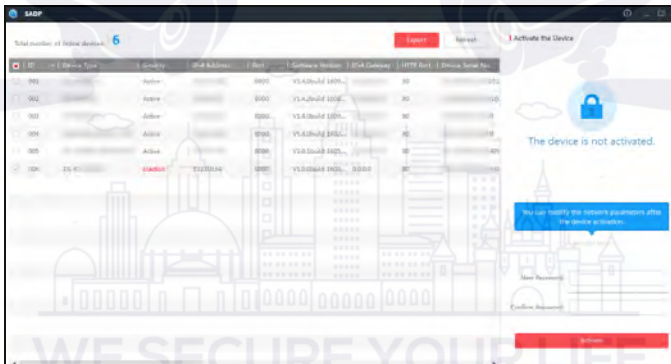

Figure 5-1 SADP Interface

3. Create a password and input the password in the password field, and confirm the password.



STRONG PASSWORD RECOMMENDED– We highly recommend you create a strong password of your own choosing (using a minimum of 8 characters, including upper case letters, lower case letters, numbers, and special characters) in order to increase the security of your product. And we recommend you reset your password regularly, especially in the high security system, resetting the password monthly or weekly can better protect your product.

4. Click **Activate** to activate the device.
5. Check the activated device. You can change the device IP address to the same network segment with your computer by either modifying the IP address manually or checking the checkbox of Enable DHCP.

Modify Network Parameters

Enable DHCP

Device Serial No.: [input field]

IP Address: [input field]

Port: 8000

Subnet Mask: [input field]

Gateways: [input field]

IPv6 Address: [input field]

IPv6 Gateway: [input field]

IPv6 Prefix Length: 0

HTTP Port: 80

Admin Password: [input field]

[Modify](#)

[Forgot Password](#)

Figure 5-2 Modify Network Parameters Interface

6. Input the password and click the **Modify** button to activate your IP address modification.

5.2 Activation via Client Software

The client software is versatile video management software for multiple kinds of devices.

Get the client software from the supplied disk or the official website, and install the software according to the prompts. Follow the steps to activate the control panel.

Steps:

1. Run the client software and the control panel of the software pops up, as shown in the figure below.

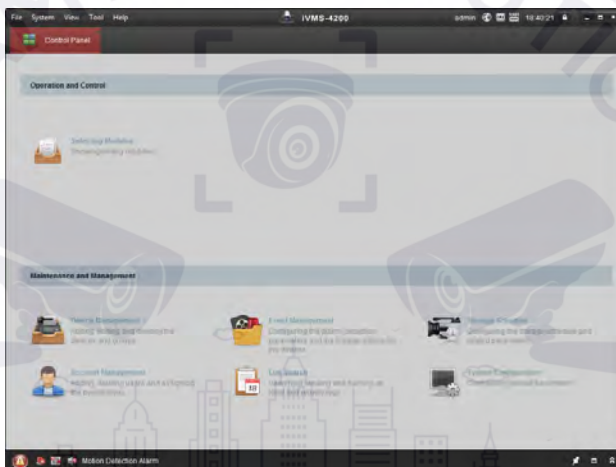

Figure 5-3 Control Panel Interface

2. Click the **Device Management** to enter the Device Management interface.
3. Check the device status from the device list, and select an inactive device.

The screenshot shows a table titled 'Online Device (19)'. The table has columns for IP, Device Type, Firmware Version, Security, Server Port, Device Serial No., and Start Time. The 'Security' column for the second device (IP 192.168.1.64) is highlighted with a red box and labeled 'Inactive'.

IP	Device Type	Firmware Version	Security	Server Port	Device Serial No.	Start Time
192.0.0.64			Active	8000		2017-01
192.168.1.64			Inactive	8000		2017-01

Figure 5-4 List Selecting Interface

4. Click the **Activate** button to pop up the Activation interface.
5. In the pop-up window, create a password in the password field, and confirm the password.



STRONG PASSWORD RECOMMENDED– *We highly recommend you create a strong password of your own choosing (using a minimum of 8 characters, including upper case letters, lower case letters, numbers, and special characters) in order to increase the security of your product. And we recommend you reset your password regularly, especially in the high security system, resetting the password monthly or weekly can better protect your product.*

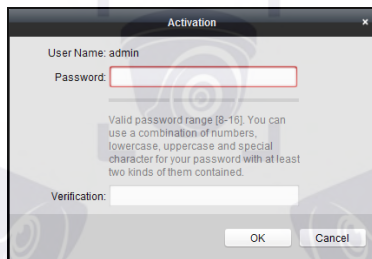

Figure 5-5 Password Interface

6. Click **OK** button to activate.
7. Click the **Modify Netinfor** button to pop up the Network Parameter Modification interface.
8. Change the device IP address to the same network segment with your computer by either modifying the IP address manually.
9. Input the password and click the **OK** button to save the settings.

020000001080505



UD09231B

Sales@collsam.com
(951)282-8707

[HTTPS://COLLSAM.COM](https://collsam.com)
Images May Not Reflect the Actual Product.
Design and specifications are subject to change without notice.

Support@collsam.com
(213)210-6744