



High Resolution Camera

User Manual

ACE-6020R/ACE-8020R
ACV-8080R/ACV-8081R
ACO-6020R/ACO-8020R



High Resolution Camera

User Manual

Copyright

©2023 Hanwha Vision Co., Ltd. All rights reserved.

Trademark

Each of trademarks herein is registered. The name of this product and other trademarks mentioned in this manual are the registered trademark of their respective company.

Restriction

Copyright of this document is reserved. Under no circumstances, this document shall be reproduced, distributed or changed, partially or wholly, without formal authorization.



Disclaimer

Hanwha Vision makes the best to verify the integrity and correctness of the contents in this document, but no formal guarantee shall be provided. Use of this document and the subsequent results shall be entirely on the user's own responsibility. Hanwha Vision reserves the right to change the contents of this document without prior notice.

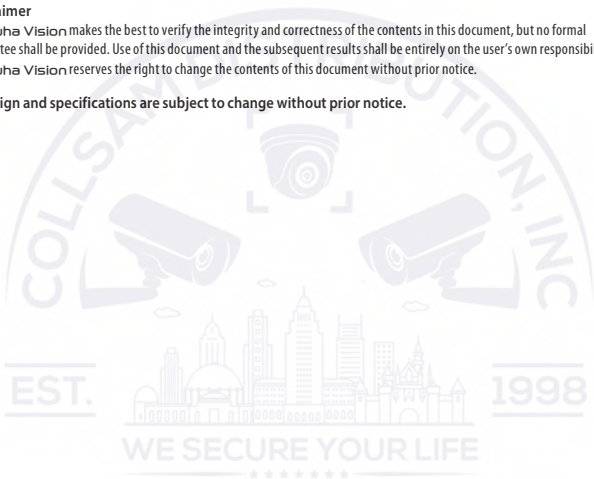
❖ Design and specifications are subject to change without prior notice.



safety information

	CAUTION RISK OF ELECTRIC SHOCK. DO NOT OPEN	
CAUTION: TO REDUCE THE RISK OF ELECTRIC SHOCK, DO NOT REMOVE COVER (OR BACK) NO USER SERVICEABLE PARTS INSIDE. REFER SERVICING TO QUALIFIED SERVICE PERSONNEL.		



This symbol indicates that dangerous voltage consisting a risk of electric shock is present within this unit.



This exclamation point symbol is intended to alert the user to the presence of important operating and maintenance (servicing) instructions in the literature accompanying the appliance.

WARNING

- To prevent damage which may result in fire or electric shock hazard, do not expose this appliance to rain or moisture.
- To prevent injury, this apparatus must be securely attached to the floor/wall in accordance with the installation instructions.

WARNING

1. Be sure to use only the standard adapter that is specified in the specification sheet. Using any other adapter could cause fire, electrical shock, or damage to the product.
2. Incorrectly connecting the power supply or replacing battery may cause explosion, fire, electric shock, or damage to the product.
3. Do not connect multiple cameras to a single adapter. Exceeding the capacity may cause abnormal heat generation or fire.
4. Securely plug the power cord into the power receptacle. Insecure connection may cause fire.
5. When installing the camera, fasten it securely and firmly. The fall of camera may cause personal injury.

safety information

6. Do not place conductive objects (e.g. screwdrivers, coins, metal parts, etc.) or containers filled with water on top of the camera. doing so may cause personal injury due to fire, electric shock, or falling objects.
7. Do not install the unit in humid, dusty, or sooty locations. doing so may cause fire or electric shock.
8. If any unusual smells or smoke come from the unit, stop using the product. in such case, immediately disconnect the power source and contact the service center. continued use in such a condition may cause fire or electric shock.
9. If this product fails to operate normally, contact the nearest service center. never disassemble or modify this product in any way. (Hanwha Vision is not liable for problems caused by unauthorized modifications or attempted repair.)
10. When cleaning, do not spray water directly onto parts of the product. doing so may cause fire or electric shock.

CAUTION

1. Do not drop objects on the product or apply strong shock to it. Keep away from a location subject to excessive vibration or magnetic interference.
2. Do not install in a location subject to high temperature (over 55°C), low temperature (below -30°C), or high humidity. Doing so may cause fire or electric shock.
3. If you want to relocate the already installed product, be sure to turn off the power and then move or reinstall it.
4. Remove the power plug from the outlet when there is a lightning. Neglecting to do so may cause fire or damage to the product.
5. Keep out of direct sunlight and heat radiation sources. It may cause fire.
6. Install it in a place with good ventilation.
7. Avoid aiming the camera directly towards extremely bright objects such as sun, as this may damage the CMOS image sensor.
8. Apparatus shall not be exposed to dripping or splashing and no objects filled with liquids, such as vases, shall be placed on the apparatus.
9. The Mains plug is used as a disconnect device and shall stay readily operable at any time
10. Do not expose the camera to radioactivity. Radioactivity exposure may damage the CMOS.

4_safety information

FCC Statement

This device complies with part 15 of the FCC Rules. Operation is subject to the following two conditions :

- 1) This device may not cause harmful interference, and
- 2) This device must accept any interference received including interference that may cause undesired operation.

CAUTION

This equipment has been tested and found to comply with the limits for a Class A digital device, pursuant to part 15 of FCC Rules. These limits are designed to provide reasonable protection against harmful interference when the equipment is operated in a commercial environment. This equipment generates, uses, and can radiate radio frequency energy and, if not installed and used in accordance with the instruction manual, may cause harmful interference to radio communications. Operation of this equipment in a residential area is likely to cause harmful interference in which case the user will be required to correct the interference at his own expense.



IC Compliance Notice

This Class A digital apparatus meets all requirements of the Canadian Interference.-Causing Equipment Regulations of ICES-003.



Correct Disposal of This Product (Waste Electrical & Electronic Equipment)

(Applicable in the European Union and other European countries with separate collection systems)

This marking on the product, accessories or literature indicates that the product and its electronic accessories (e.g. charger, headset, USB cable) should not be disposed of with other household waste at the end of their working life. To prevent possible harm to the environment or human health from uncontrolled waste disposal, please separate these items from other types of waste and recycle them responsibly to promote the sustainable reuse of material resources.

Household users should contact either the retailer where they purchased this product, or their local government office, for details of where and how they can take these items for environmentally safe recycling.

Business users should contact their supplier and check the terms and conditions of the purchase contract. This product and its electronic accessories should not be mixed with other commercial wastes for disposal.



Correct disposal of batteries in this product

(Applicable in the European Union and other European countries with separate battery return systems.)

This marking on the battery, manual or packaging indicates that the batteries in this product should not be disposed of with other household waste at the end of their working life. Where marked, the chemical symbols Hg, Cd or Pb indicate that the battery contains mercury, cadmium or lead above the reference levels in EC Directive 2006/66. If batteries are not properly disposed of, these substances can cause harm to human health or the environment.

To protect natural resources and to promote material reuse, please separate batteries from other types of waste and recycle them through your local, free battery return system.

English_5

important safety instructions

1. Read these instructions.
2. Keep these instructions.
3. Heed all warnings.
4. Follow all instructions.
5. Do not use this apparatus near water.
6. Clean only with dry cloth.
7. Do not block any ventilation openings. Install in accordance with the manufacturer's instructions.
8. Do not install near any heat sources such as radiators, heat registers, or other apparatus (including amplifiers) that produce heat.
9. Do not defeat the safety purpose of the polarized or grounding-type plug. A polarized plug has two blades with one wider than the other. A grounding type plug has two blades and a third grounding prong. The wide blade or the third prong is provided for your safety. If the provided plug does not fit into your outlet, consult an electrician for replacement of the obsolete outlet.
10. Protect the power cord from being walked on or pinched particularly at plugs, convenience receptacles, and the point where they exit from the apparatus.
11. Only use attachments/accessories specified by the manufacturer.
12. Use only with cart, stand, tripod, bracket, or table specified by the manufacturer, or sold with the apparatus.
13. Unplug this apparatus when a card is used. Use caution when moving the cart/ apparatus combination to avoid injury from tip-over.
14. Refer all servicing to qualified service personnel. Servicing is required when the apparatus has been damaged in any way, such as powersupply cord or plug is damaged, liquid has been spilled or objects have fallen into the apparatus, the apparatus has been exposed to rain or moisture, does not operate normally, or has been dropped.
15. This product is intended to be supplied by a UL Listed Power Supply Unit marked "Class 2" or "LPS" or "PS2" and rated from 12 Vdc 0.3 A. (ACE-6020R/ACO-6020R)
16. This product is intended to be supplied by a UL Listed Power Supply Unit marked "Class 2" or "LPS" or "PS2" and rated from 12 Vdc 0.45 A. (ACE-8020R/ACO-8020R)
17. This product is intended to be supplied by a UL Listed Power Supply Unit marked "Class 2" or "LPS" or "PS2" and rated from 12 Vdc 0.6 A. (ACV-8080R/ACV-8081R)
18. If you use excessive force when installing the product, the camera may be damaged and malfunction.
If you forcibly install the product using non-compliant tools, the product may be damaged.



6_ important safety instructions

important safety instructions

19. Do not install the product in a place where chemical substances or oil mist exists or may be generated. As edible oils such as soybean oil may damage or warp the product, do not install the product in the kitchen or near the kitchen table.
This may cause damage to the product.
20. When installing the product, be careful not to allow the surface of the product to be stained with chemical substance.
Some chemical solvents such as cleaner or adhesives may cause serious damage to the product's surface.
21. If you install/disassemble the product in a manner that has not been recommended, the production functions/performance may not be guaranteed.
Install the product by referring to "Installation & connection" in the user manual.
22. Installing or using the product in water can cause serious damage to the product.
23. The operating temperature of the product is -30°C to +55°C (-22°F ~ +131°F)



Apparatus shall not be exposed to dripping or splashing and no objects filled with liquids, such as vases, shall be placed on the apparatus



Hanwha Vision cares for the environment at all product manufacturing stages, and is taking measures to provide customers with more environmentally friendly products.

The Eco mark represents Hanwha Vision's devotion to creating environmentally friendly products, and indicates that the product satisfies the EU RoHS Directive.

English_7

contents

INTRODUCTION	9	Features
	10	Components and Accessories
	13	Component names and functions

INSTALLATION	16	Before Installation
	16	Installation (ACE-6020R/ACE-8020R)
	19	Installation (ACV-8080R/ACV-8081R)
	21	Installation (ACO-6020R/ACO-8020R)
	23	Adjusting the monitoring direction for the camera

CONNECTION	25	Connecting with other Device
-------------------	-----------	------------------------------

CAMERA OPERATION	28	Menu Configuration
	28	Menu Setup

TROUBLESHOOTING	35	Troubleshooting
------------------------	-----------	-----------------

introduction

FEATURES

- **High Resolution**
Supports up to 2 megapixel (1920 x 1080) resolution: : ACE-6020R/ACO-6020R
Supports up to 5 megapixel (2592 x 1944) resolution: ACE-8020R/ACO-8020R/
ACV-8080R/ACV-8081R
- **D-WDR**
If an object has a large variance between bright and dark areas, it will keep bright areas bright and make selected dark areas bright, so that the overall brightness can be maintained.
- **WDR(ACV-8081R)**
By adopting a proprietary high performance DSP chip, the camera delivers clear, high quality pictures even in backlight, by increasing exposure in dark areas while decreasing it in bright areas.
- **Day&Night**
This camera has a function that automatically selects the mode that is appropriate for day-time or night-time conditions. The COLOR mode operates in daytime conditions to provide optimum colors, and B/W mode operates in night-time conditions to enhance the definition of the image.
- **Miscellaneous Functions**
SSNR4, MIRROR, ROTATE, SHARPNESS functions are provided.
- **Communication**
Coaxial communication methods are supported.
- ACP(AHD Coax Protocol), TCP(TVI Coax Protocol), CCP(CVI Coax Protocol)
CVBS : Pelco-C(Coaxitron)
- **OSD**
The camera's OSD is complimented by 7 languages.
- English, German, Italian, French, Spanish, Portuguese, Japanese(ACE-8020R/ACO-8020R/
ACV-8080R/ACV-8081R only)

introduction

COMPONENTS AND ACCESSORIES

Check if the following items are included in the product package.

<ACE-6020R/ACE-8020R>

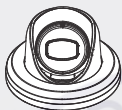

Camera



Quick Guide



Tapping Screws



Plastic Anchor



Template

10_introduction

<ACV-8080R/ACV-8081R>

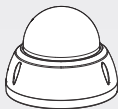

Camera



Quick Guide



Tapping Screws



Plastic Anchor



Hex. L wrench



Template

● INTRODUCTION

EST.



1998

WE SECURE YOUR LIFE

English_11

introduction

<ACO-6020R/ACO-8020R>

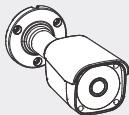

Camera



Quick Guide



Tapping Screws



Plastic Anchor



Hex. L wrench



Template

12_introduction

COMPONENT NAMES AND FUNCTIONS

ACE-6020R/ACE-8020R

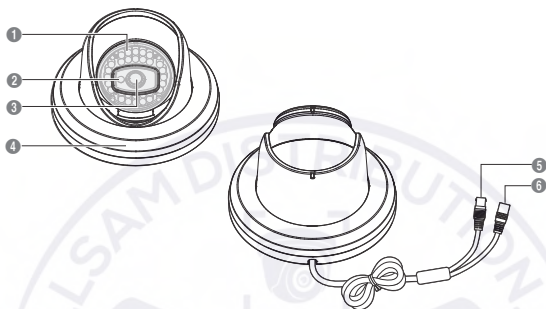

- 1 **IR LED** : These infrared LEDs are controlled by the illumination sensor.
- 2 **Illumination sensor** : Detects incoming light to control the IR LED.
- 3 **Lens Module**
- 4 **Middle Cover**
- 5 **Video Output Jack** : Video signals are output through this port. Connect this port to the Video IN port of a DVR.
- 6 **Power Input Connector (DC12V)**

introduction

ACV-8080R/ACV-8081R

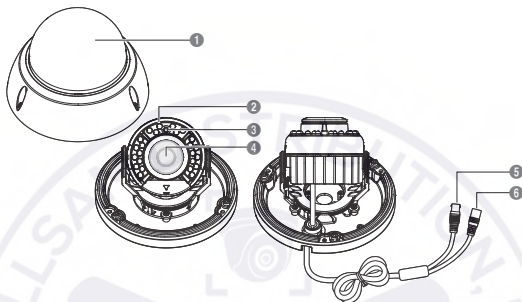

- 1 Dome Cover
- 2 IR LED : These infrared LEDs are controlled by the illumination sensor.
- 3 Illumination sensor : Detects incoming light to control the IR LED.
- 4 Lens Module
- 5 Video Output Jack : Video signals are output through this port. Connect this port to the Video IN port of a DVR.
- 6 Power Input Connector (DC12V)

14_introduction

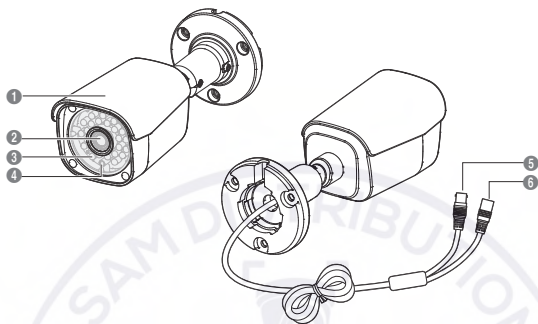

- 1 Camera Sunshield
- 2 Lens Module
- 3 IR LED : These infrared LEDs are controlled by the illumination sensor.
- 4 Illumination sensor : Detects incoming light to control the IR LED.
- 5 Video Output Jack : Video signals are output through this port. Connect this port to the Video IN port of a DVR.
- 6 Power Input Connector (DC12V)

Installation

BEFORE INSTALLATION

Ensure you read out the following instructions before installing the camera:

- You have to check whether the location (ceiling or wall) can bear five times the weight of your camera.
- Don't let the cable to be caught in improper place or the electric line cover to be damaged. Otherwise it may cause a breakdown or fire.
- Before installing your camera, you have to adjust the lens focus, zoom, and switch settings.
- When installing your camera, don't allow any person to approach the installation site.
- The installation should be done by qualified service personnel or system installers.
- If the ceiling material is not strong enough to hold the installation screws, the camera may fall off. Reinforce the ceiling as needed.

INSTALLATION(ACE-6020R/ACE-8020R)

Disassembling

1. Use one hand to hold the camera's bottom part and turn the middle cover counterclockwise with another hand to separate it.

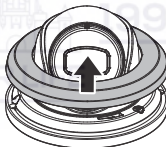
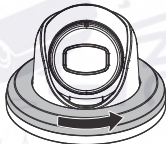

Installation

1. Attach the template for the installation and drill holes according to the template.

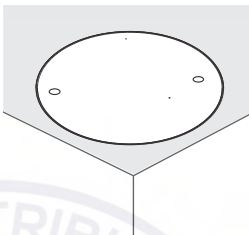

● INSTALLATION

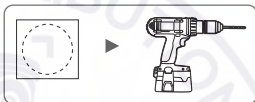

2. Insert plastic anchors into the installation holes and use 2 tapping screws to firmly place the camera.
3. After connecting the power and video cables, arrange the cables through the appropriate grooves. Be careful not to twist the cable.

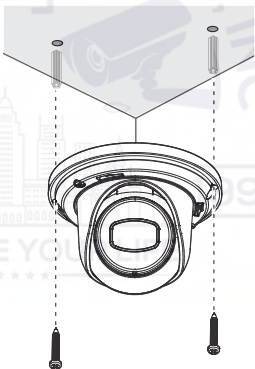

English_17

Installation

4. Use a Phillips screwdriver to loosen the screws of the bracket that fixes the inner cover.
5. Adjust the lens in a desired direction by referring to the **"Adjusting the monitoring direction for the camera"** section. (page 23)

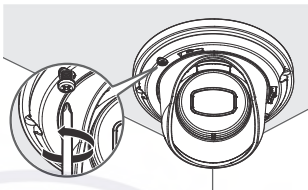

6. Put the middle cover back and rotate it clockwise until it is firmly in place.

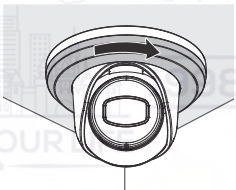
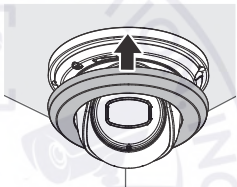

INSTALLATION(ACV-8080R/ACV-8081R)

Disassembling

1. Using the Torx L wrench provided, turn the 3 fastening bolts on the dome cover counter clockwise to remove the cover.

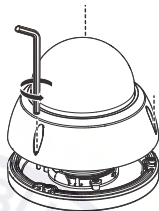

● INSTALLATION

Installation

1. Attach the template for the installation and drill holes according to the template.

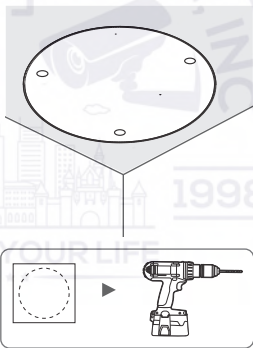

English_19

Installation

2. Insert plastic anchors into the installation holes and use 3 tapping screws to firmly place the camera.
3. After connecting the power and video cables, arrange the cables through the appropriate grooves. Be careful not to twist the cable.
4. Adjust the lens in a desired direction by referring to the **"Adjusting the monitoring direction for the camera"** section. (page 23)

5. Close the dome cover.
 - To ensure waterproofing, tight up the fixing bolts using the Torx L wrench.

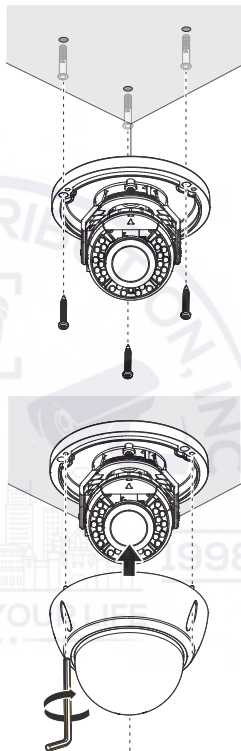

INSTALLATION(ACO-6020R/ACO-8020R)

Installation

1. Attach the template for the installation and drill holes according to the template.

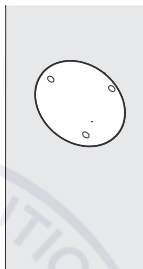

● INSTALLATION



2. Insert plastic anchors into the installation holes and use 3 tapping screws to firmly place the camera.
3. After connecting the power and video cables, arrange the cables through the appropriate grooves. Be careful not to twist the cable.

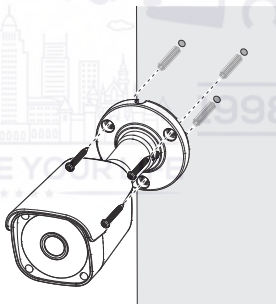

English_21

Installation

4. Adjust the camera direction using the Torx L wrench.
5. Adjust the lens in a desired direction by referring to the **"Adjusting the monitoring direction for the camera"** section. (page 24)

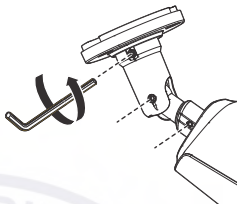

ADJUSTING THE MONITORING DIRECTION FOR THE CAMERA

<ACE-6020R/ACE-8020R>

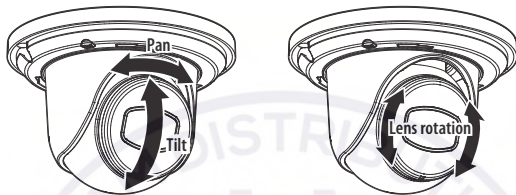

<ACV-8080R/ACV-8081R>

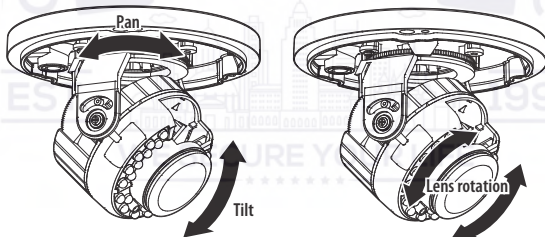

● INSTALLATION

English_23

Installation

<ACO-6020R/ACO-8020R>

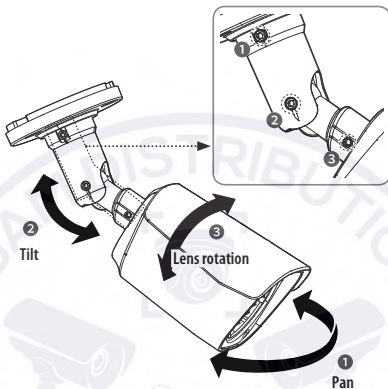

- **Adjusting the monitoring direction**
You can adjust the camera direction only when the camera is fixed on the ceiling. Where, rotating the camera unit to the left or right is called Pan, adjusting the tilt is called Tilt, and turning the lens on its axis is called Rotation.
- **Methods of adjustment**
 1. After installing the camera, adjust the panning angle in consideration of the monitoring direction.
 2. Adjust the view angle and focus for the video.
- For convenience of operation, adjust the rotation part to fix the lever.
 3. Set the horizontal angle so that the image is not reversed.
 4. Adjust the tilt angle so that the camera faces toward the monitoring object.

connection

CONNECTING WITH OTHER DEVICE

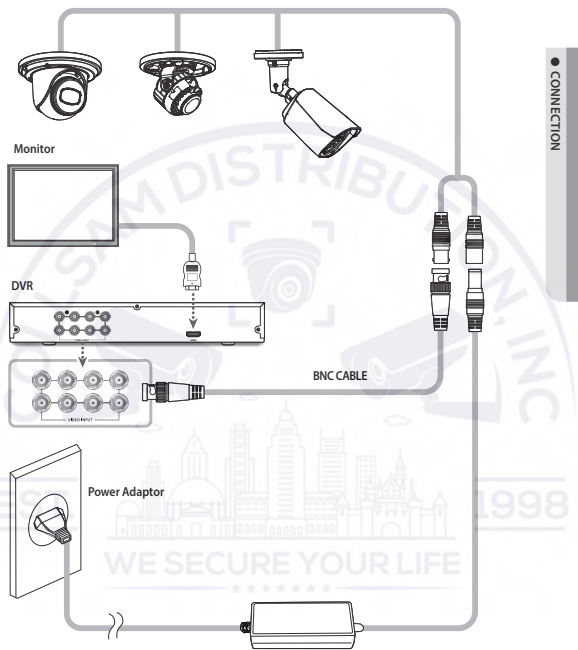

English_25

connection

Connecting to Monitor

1. Connect the video output port of the camera to the video input port of the DVR using a BNC cable.
2. Use an HDMI cable to connect the monitor and the DVR.



- As the connecting method varies with the instruments, refer to the manual supplied with the instrument.
- Only connect the cable when the power is turned off.
- This product supports 4 video output formats of AHD, TVI, CVI, CVBS. The default is AHD. Select the video output appropriate for your DVR.

- Video Cable

The camera's video output port is connected to the DVR with a BNC coaxial cable, shown below.

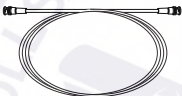

Distance	Recommended Cable Specification
300m	5C2V



- When controlling the camera through coaxial communication, use only video amplifiers exclusively for coaxial communication. When using a general video amplifier, coaxial communication signals are not transmitted.

Connecting to Power

1. Connect the power port of the camera to the power adaptor.
2. Connect the power adaptor cord to an outlet.



- Purchase and install an adaptor that meets the camera's power specifications.
- Be sure to connect power only after all the installation is complete.

- When the resistance value of copper wire is at [20°C(68°F)]

Copper wire size (AWG)	#24 (0.22mm ²)	#22 (0.33mm ²)	#20 (0.52mm ²)	#18 (0.83mm ²)
Resistance value(Ω/m)	0.078	0.050	0.030	0.018
Voltage Drop (V/m)	0.028	0.018	0.011	0.006

- As shown in the table above, voltage decreases as the wire gets longer. Therefore use of an excessively long adaptor output line for connection to the camera may affect the performance of the camera.
- ※ Standard voltage for camera operation : DC 12V±10%
- ※ There may be some deviation in voltage drop depending on the type of wire and the manufacturer.



camera operation

MENU CONFIGURATION

MAIN SETUP			
VIDEO FORMAT	• AHD • CVBS	• TVI	• CVI
WHITE BAL	• ATW	• AWC → SET	
EXPOSURE	• BRIGHTNESS • AGC • RETURN	• LENS • SSNR4	• SHUTTER • D-WDR
BACKLIGHT	• OFF	• BLC	• WDR (ACV-8081R)
SPECIAL	• LANGUAGE • RETURN	• IMAGE ADJ	• DAY/NIGHT
AF (ACV-8080R/ACV-8081R)	• AF MODE • LENS INIT	• ONE SHOT AF • POWER INIT	• TDN AF • RETURN
EXIT	• SAVE&END	• NOT SAVE	• RESET

MENU SETUP

The OSD can be controlled through the “Camera setup” menu of the DVR connected to the camera. Refer to the user manual of the connected DVR for how to use it.

MAIN SETUP	
▶ 1. VIDEO FORMAT	AHD ↵
2. WHITE BAL	ATW
3. EXPOSURE	↵
4. BACKLIGHT	OFF
5. SPECIAL	↵
6. AF	↵
7. EXIT	SAVE&END



- An item with the ↵ icon also has sub menus. To select a sub menu, select an item with the icon and press the ENTER button.
- An item with the --- icon is unavailable due to function settings.

VIDEO FORMAT

1. Select the <**VIDEO FORMAT**> item from the main setup screen and press the **ENTER** button.

- The video output can be selected from AHD/TVI/CVI/CVBS.

MAIN SETUP	
▶ 1. VIDEO FORMAT	AHD←↓
2. WHITE BAL	ATW
3. EXPOSURE	←↓
4. BACKLIGHT	OFF
5. SPECIAL	←↓
6. AF	←↓
7. EXIT	SAVE&END

WHITE BAL (WHITE BALANCE)

Use the White Balance function to adjust the screen color.

1. Select the <**WHITE BAL**> item from the main setup screen and press the **ENTER** button.

2. Select a mode that you want.

※ Select one of the following 2 modes, as appropriate for your purpose.

- **ATW**: Select this when the color temperature is between 2,300K and 10,500K.
- **AWC→SET**: When setting the menu, shine the camera light on a white paper to determine the most suitable state for the current lighting environment and wait for 3 seconds so that the current value can be saved. Readjust the value when the environment changes.

MAIN SETUP	
1. VIDEO FORMAT	AHD←↓
▶ 2. WHITE BAL	ATW
3. EXPOSURE	←↓
4. BACKLIGHT	OFF
5. SPECIAL	←↓
6. AF	←↓
7. EXIT	SAVE&END



- White Balance may not work properly under the following conditions. In this case select the AWC mode.

- ① Select this When the color temperature of environment surrounding the subject is out of the control range (e.g. clear sky, or sunset)
- ② When the ambient illumination of the subject is dim.

- If the camera is directed towards a fluorescent light or is installed in a place where illumination changes dramatically, the White Balance operation may become unstable.

English_29

camera operation

EXPOSURE

1. Select the <EXPOSURE> item from the main setup screen and press the **ENTER** button.

2. Set the submenus of the EXPOSURE settings.

- **BRIGHTNESS** : Adjusts the video brightness.
- **LENS**: Select the type of lens.
 - **DC**: Select the automatic diaphragm lens.
 - **MANUAL**: The shutter does not automatically move but is fixed to the maximal degree in this mode.
- **SHUTTER** : You can select the shutter.
 - **MIN** : 1/30~1/10000
 - **MAX** : 1/60~1/50000
 - **A.FLK**: Select this when you experience picture flicker, this happen when there is a clash with the installed lighting frequency.



- The greater the shutter value the brighter the screen is but the more the residual images of objects there are.
- If the min shutter value is large, it can cause noise, spots and white areas but still operate normally.
- Depending on the setting range of the minimal/maximal shutter, the screen exposure can become saturated.

- **AGC (OFF/LOW/MIDDLE/HIGH)** :
The higher the gain level, the brighter the screen - but the greater the noise.
- **SSNR4** : Remove noise from the image. The higher the level, the less the noises, but then the video might become fuzzy.
 - **2 DNR/3 DNR** : OFF/LOW/MIDDLE/HIGH
- **D-WDR(0 ~ 7)**: If an object has a large variance between bright and dark areas, it will keep bright areas bright and make selected dark areas bright, so that the overall brightness can be maintained. The higher the level, the greater the effect.

MAIN SETUP	
1. VIDEO FORMAT	AHD ₄ ↓
2. WHITE BAL	ATW
▶ 3. EXPOSURE	←↓
4. BACKLIGHT	OFF
5. SPECIAL	←↓
6. AF	←↓
7. EXIT	SAVE&END

IMAGE SETUP	
▶ 1. BRIGHTNESS	▬▬▬▬▬▬▬▬▬ 25
2. LENS	MANUAL
3. SHUTTER	←↓
4. AGC	MIDDLE
5. SSNR4	ON ₄ ↓
6. D-WDR	OFF
7. RETURN	RET ₄ ↓

BACKLIGHT

You can clearly see the subject and the background at the same time, even with the backlight.

1. Select the <BACKLIGHT> item from the main setup screen and press the **ENTER** button.

2. Set the backlight compensation function.

- **BLC** : Enables a user to select a desired area on a picture and view that area more clearly.

- **LEVEL** : Adjusts the brightness level of a monitoring area. (LOW/MIDDLE/HIGH)
- **BLC AREA** : Adjust the area to be enhanced. (POS / SIZE / RET / AGAIN)
- **RETURN** : Return to the MAIN SETUP menu.

- **WDR** :

(The <WDR> function is only supported in the ACV-8081R model.)
When there are both bright and dark areas at the same time, this mode makes both areas distinctive.

- **LEVEL** : You can adjust the brightness of the area that you want to monitor. (LOW/MIDDLE/HIGH)
- **RETURN** : Return to the MAIN SETUP menu.

MAIN SETUP	
1. VIDEO FORMAT	AHD ↵
2. WHITE BAL	ATW
3. EXPOSURE	↵
▶ 4. BACKLIGHT	OFF
5. SPECIAL	↵
6. AF	↵
7. EXIT	SAVE&END

BLC AREA	
▶ 1. LEVEL	MIDDLE
2. BLC AREA	↵
3. DEFAULT	↵
4. RETURN	RET ↵

WDR LEVEL	
▶ 1. LEVEL	MIDDLE
2. RETURN	RET ↵

camera operation

SPECIAL

1. Select the <**SPECIAL**> item from the main setup screen and press the **ENTER** button.
2. Set the submenus of the SPECIAL settings.

- **LANGUAGE**: Select the screen language. The initial value is set to <English>.

- **IMAGE ADJ**

- **COLOR GAIN** :

The setting range is 1 ~ 10. The smaller the setting value is the smaller the color gain gets and the more color blind it gets.

- **BLUE GAIN** : 1 ~ 10
- **RED GAIN** : 1 ~ 10

- **SHARPNESS** : Select a mode to adjust the thickness of an image's sharpness.

- **OFF** : Released state
- **ON** : Adjust the value so that it's appropriate for each video. (LOW/MIDDLE/HIGH)

- **MIRROR**

- **MIRROR**: Flip an image horizontally.
- **V-FLIP**: Flip an image vertically.
- **ROTATE**: Rotate the image.

- **RETURN** : Return to the SPECIAL menu.



- If you increase the SHARPNESS level too high, the picture may become distorted or noise may appear.

- **DAY/NIGHT**: You can display pictures in color or in black and white.

- **AUTO** : The mode is switched to <COLOR> in a normal environment, but switches to <B/W> mode when ambient illumination is low.

- **DURATION** : This function is used to select the brightness of light where switching occurs. (NORMAL/FAST/SLOW)

- **COLOR** : The picture is always displayed in color.

- **B/W** : The picture is always displayed in black and white.

MAIN SETUP	
1. VIDEO FORMAT	AHD _↓
2. WHITE BAL	ATW
3. EXPOSURE	↓
4. BACKLIGHT	OFF
▶ 5. SPECIAL	↓
6. AF	↓
7. EXIT	SAVE&END

IMAGE SETUP	
▶ 1. COLOR GAIN	↓
2. SHARPNESS	ON _↓
3. MIRROR	OFF
4. RETURN	↓

AF(AUTO FOCUS)

(The <AF> function is only supported in the ACV-8080R/ACV-8081R models.)

1. Select the <AF> item from the main setup screen and press the **ENTER** button.
2. Set the submenus of the AF settings.

- **AF MODE :**

- SEMI: Performs the AF function when power is turned ON/OFF, but does not perform AF after operation.
- MANUAL: Moves to WIDE when power is turned ON/OFF and does not perform the AF function.
- OFF: Does not perform the AF function.

- **ONE SHOT AF:** Select if you want to focus the video from the current position.

- **TDN AF:** Select whether to readjust focus after D/N conversion.

- **LENS INIT:** Initialize the location of the AF lens.

- **POWER INIT :**

- SAVE POSI: Remember the location prior to power OFF, move to the location, and perform AF.
- WIDE: Move to WIDE and perform AF when power is applied.
- OFF: Does not perform AF when power is applied.

MAIN SETUP	
1. VIDEO FORMAT	AHD _↓
2. WHITE BAL	ATW
3. EXPOSURE	↓
4. BACKLIGHT	OFF
5. SPECIAL	↓
▶ 6. AF	↓
7. EXIT	SAVE&END



camera operation

EXIT

- **SAVE&END** : Save the current settings and exit the MAIN SETUP menu.
- **NOT SAVE** : Do not save the current settings and exit the MAIN SETUP menu.
- **RESET** : Return the camera to its factory default state. However, the language settings and lens zoom position are not initialized.



troubleshooting

TROUBLESHOOTING

If you have trouble operating your camera, refer to the following table.
If the guidelines do not enable you to solve the problem, contact an authorized technician.

Problems	Troubleshooting
Nothing appears on the screen.	<ul style="list-style-type: none">• Check that the power cord and line connection between the camera and monitor are properly connected.• Check that you have properly connected BNC cable to the camera.
The image on the screen is dim.	<ul style="list-style-type: none">• Is lens stained with dirt? Clean your lens with soft, clean cloth.• Adjust the monitor status.• If the camera is exposed to very strong light, change the camera position.
The image on the screen is dark.	<ul style="list-style-type: none">• Adjust the contrast feature of the monitor or DVR.• If you have an intermediate device, set the 75Ω / Hi-z properly.
The camera is not working properly, and the surface of the camera is hot.	<ul style="list-style-type: none">• Check that you have properly connected the camera to an appropriate power source.
The DAY/NIGHT menu does not work.	<ul style="list-style-type: none">• Check that AGC of EXPOSURE setup menu is 'OFF'.
Color is not correct.	<ul style="list-style-type: none">• Check the setting of WHITE BAL setup menu
The screen flickers continually.	<ul style="list-style-type: none">• Ensure the camera is not pointing towards the sun.