



# NETWORK CAMERA

## Quick Guide

QNE-C9013RL  
QNE-C8013RL



Sales@collsam.com | [www.collsam.com](http://www.collsam.com)  
(951) 283-8707 | (613) 210-6744

Design and specifications are subject to change without notice.

### Important

Please check 'Manuals' from our website, before connecting to the Supply,  
<https://www.hanwhavision.com/en/download-data/>

### Warranty

Please check "Product warranty information" from our website.  
<https://www.hanwhavision.com/en/support/warranty/>

We recommend to use the officially compatible VMS version or latest Hanwha NVR version when integrating with VMS or Hanwha NVR.

The Risk Group 1 of a LEDs include in the equipment, so should be attached RG1 warning label at the end-product.



Hanwha Vision cares for the environment at all product manufacturing stages, and is taking measures to provide customers with more environmentally friendly products.  
The Eco mark represents Hanwha Vision's devotion to creating environmentally friendly products, and indicates that the product satisfies the EU RoHS Directive.



#### Correct Disposal of This Product (Waste Electrical & Electronic Equipment)

(Applicable in the European Union and other European countries with separate collection systems)  
This marking on the product, accessories or literature indicates that the product and its electronic accessories (e.g. charger, headset, USB cable) should not be disposed of with other household waste at the end of their working life. To prevent possible harm to the environment or human health from uncontrolled waste disposal, please separate these items from other types of waste and recycle them responsibly to promote the sustainable reuse of material resources.

Household users should contact either the retailer where they purchased this product, or their local government office, for details of where and how they can take these items for environmentally safe recycling. Business users should contact their supplier and check the terms and conditions of the purchase contract. This product and its electronic accessories should not be mixed with other commercial wastes for disposal.



#### Correct disposal of batteries in this product

(Applicable in the European Union and other European countries with separate battery return systems.)

This marking on the battery, manual or packaging indicates that the batteries in this product should not be disposed of with other household waste at the end of their working life. Where marked, the chemical symbols Hg, Cd or Pb indicate that the battery contains mercury, cadmium or lead above the reference levels in EC Directive 2006/66. If batteries are not properly disposed of, these substances can cause harm to human health or the environment.

To protect natural resources and to promote material reuse, please separate batteries from other types of waste and recycle them through your local, free battery return system.

Sales@colson.com COLSON.COM  
(951)286-8707 Not Reflect the Actual Product

Design and specifications are subject to change without notice.

## SAFETY INFORMATION

---



3

Sales@collsam.com | <https://collsam.com>  
(951) 283-8707 | Not Reflect the Actual Product

Design and specifications are subject to change without notice.

## COMPONENT

---

As for each sales country, accessories are not the same.

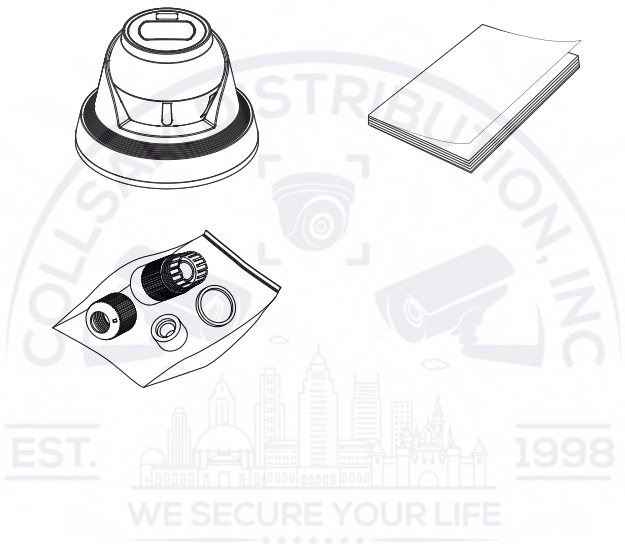

## INSTALLATION

1

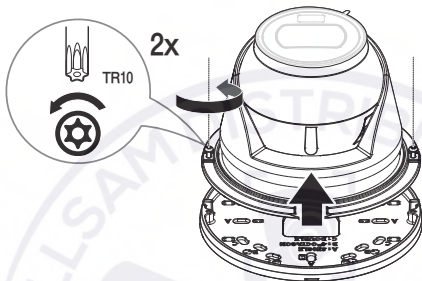

2-1

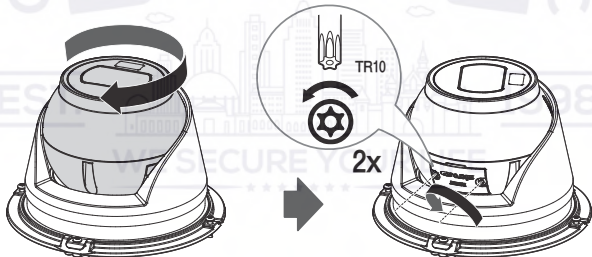

5

Sales@coltsam.com <https://coltsam.com> coltsam.com  
(951)283-8707 Not Reflect the Actual Product (213)210-6744

Design and specifications are subject to change without notice.

## INSTALLATION

- 2-2 • Not Included : Micro SD Card

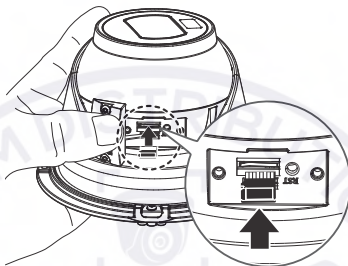

- 3 • Directly installing on wall/ceiling

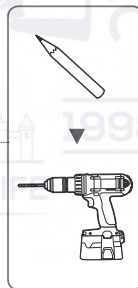
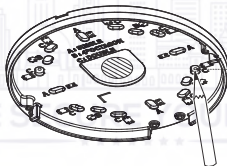

## INSTALLATION

4-1

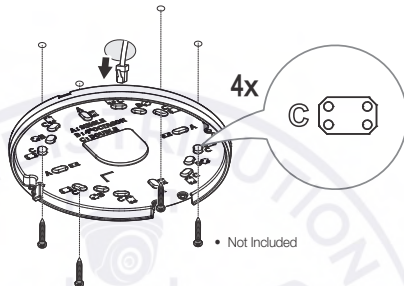

4-2

- When connecting the cable through the side

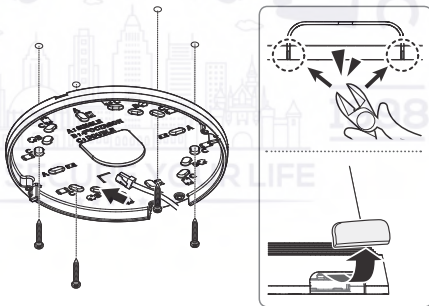

7

Sales@coltsam.com | <https://coltsam.com> | coltsam.com  
(951) 283-8797 | Not Reflect the Actual Product | (213) 210-6744

Design and specifications are subject to change without notice.

## INSTALLATION

5

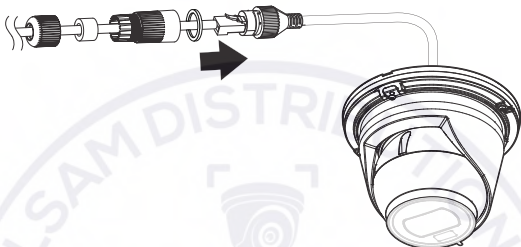

6

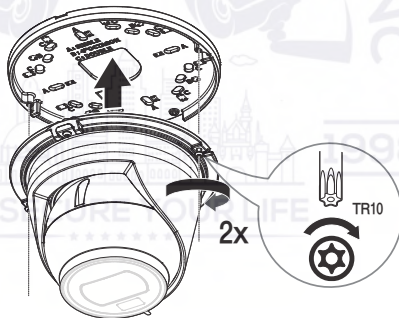

8

Sales@coltsam.com | <https://coltsam.com> | coltsam.com  
(951) 283-8797 | (913) 210-6744

Design and specifications are subject to change without notice.

## INSTALLATION

7

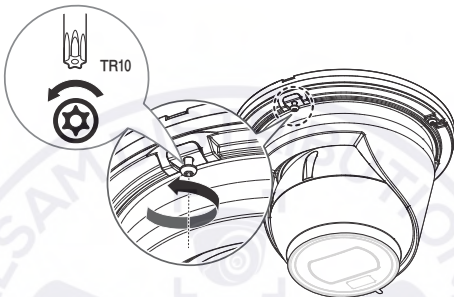

8



9

Sales@coltsam.com | <https://coltsam.com> | coltsam.com  
(951) 283-8707 | (951) 210-6744

Design and specifications are subject to change without notice.

# INSTALLATION

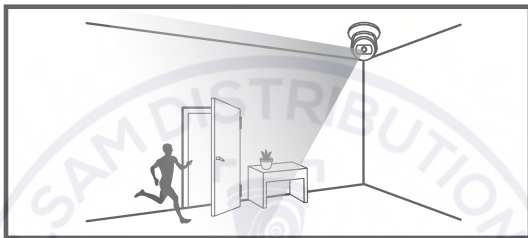

9

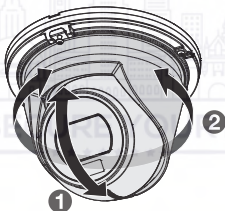

10

Sales@colsam.com | <https://colsam.com> | colsam.com  
(951) 283-8707 | (951) 210-6744

Design and specifications are subject to change without notice.

## INSTALLATION

10

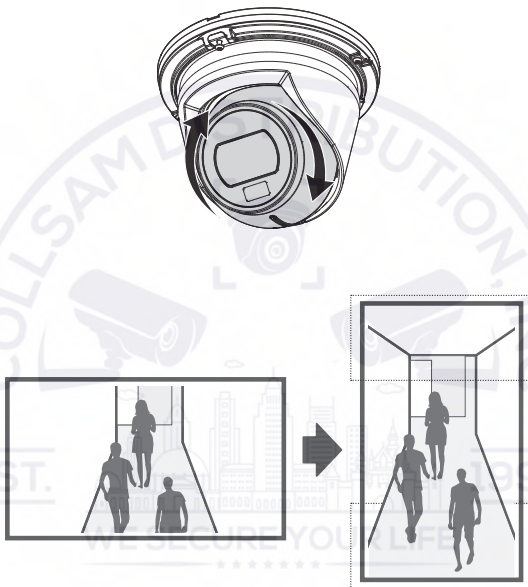

11

Sales@collsam.com | <https://collsam.com> | collsam.com  
(951) 283-8797 | (951) 210-6744

Design and specifications are subject to change without notice.

## INSTALLATION

11

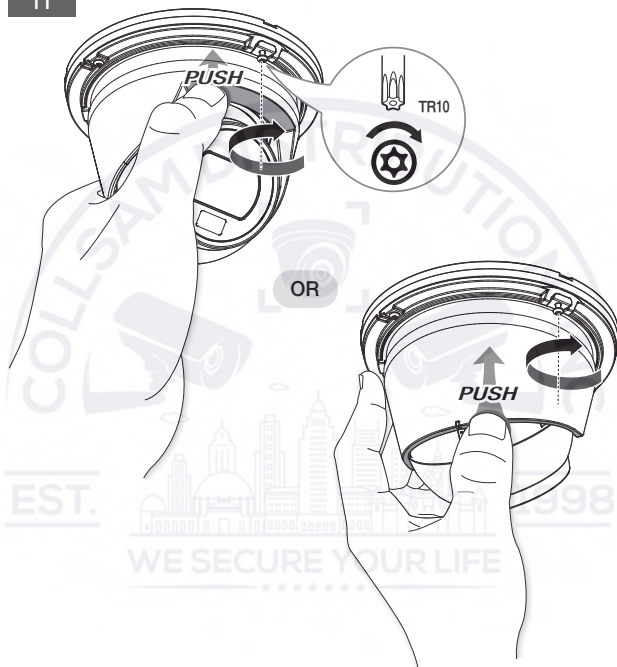



12

Sales@collsam.com | <https://collsam.com> | collsam.com  
(951) 283-8707 | Not Reflect the Actual Product

Design and specifications are subject to change without notice.

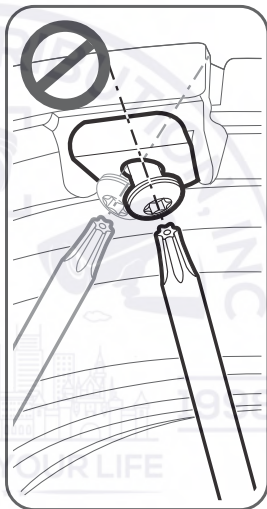
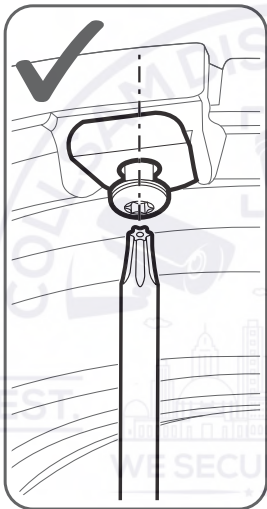
## INSTALLATION



 Don't install the screws at an angle.

## INSTALLATION

---

12



14

Sales@collsam.com | <https://collsam.com> | collsam.com  
(951) 283-8707 | (913) 210-6744  
Images May Not Reflect the Actual Product.

Design and specifications are subject to change without notice.

## PASSWORD SETTING

When you access the product for the first time, you must register the login password.



- For a new password with 8 to 9 characters, you must use at least 3 of the following: uppercase/lowercase letters, numbers and special characters. For a password with 10 characters or longer, you must use at least 2 types of those mentioned. (support up to 64 characters)
  - Special characters that are allowed. :  
~!@#\$%^&\*()\_+={}|~\:"'<>.,?/
- Space is not allowed for password.
- For higher security, you are not recommended to repeat the same characters or consecutive keyboard inputs for your passwords.
- If you lost your password, you can press the [RESET] button to initialize the product. So, don't lose your password by using a memo pad or memorizing it.

## LOGIN

Whenever you access the camera, the login window appears.

Enter the User ID and password to access the camera.

- Enter **"admin"** in the <User Name> input box.
- Enter the password in the <Password> input field.
- Click [Sign in].