

# Network Camera

Online help



XND-9082RV/XND-9082RF/  
XNV-9082R/XNO-9082R/  
XND-8082RV/XND-8082RF/  
XNV-8082R/XNO-8082R

EST.

1998



WE SECURE YOUR LIFE



## Live screen

You can check the live screen to view what is being captured by the camera and control screen capture, and other features. When you click the  button on the screen, the live screen will appear.

You can move to the live screen, playback screen or setup screen by clicking the buttons at the top.



-  (Live): Check the live screen to view what is being captured by the camera and control a variety of camera features.
-  (Playback): Search and playback a recorded image from an SD card or NAS.
-  (Setup): Change the camera settings.











### Note



- If a high resolution video is played on the live screen, a PLUGINFREE is automatically generated, which optimizes the high resolution video. The generated PLUGINFREE profile can be found in [Setup]>[Basic]>[Video profile].
- If you click the icon  at the top right of the live page, you can see the connected IP address and the authentication status. If successfully authenticated, the icon will be colored in green. If failed to be authenticated, it will be colored in red. If authentication is irrelevant due to the use of HTTP connection, dash (-) will be displayed.
- Connecting to the web viewer via Chrome, the record playback screen feature can be securely used.
- When playing a video on the live page, ghosting might occur under one of the following cases:
  - When the resolution changed after changing the profile
  - When the data transfer is delayed due to network delay after changing the profile
  - When the size or location of the web browser window changed

## Icons

The icons at the bottom of the live screen provide the following functions (Some functions may not work with a certain browsers or codecs.):

Icon	Description of function
 <u>Video setup</u>	You can check or change the profile applied to the current live screen. You can also change the display settings of the live screen.
 <u>PTZ</u>	You can control the Pan/Tilt/Zoom motions of the camera. PTZ operates only if the Video profile applied to the current live screen supports digital PTZ. To change to a digital PTZ control profile, select [Digital PTZ profile] from [Setup]>[Basic]>[Video profile]>[Video profile]>[Profile type].
 <u>Status</u>	Check the connection information for each profile and for connected users at the same time.

Icon	Description of function
 Full screen	View the live screen in full screen. To return to the size of the previous web browser, click the  icon in full screen mode or press the [Esc] key on the keyboard.
Size option	The size changes to the next size each time you click it. <ul style="list-style-type: none"> <li>•  (Fit): Fit the camera image to the size of the web browser.</li> <li>•  (Original Size): View the camera image at its actual resolution.</li> <li>•  (Aspect Ratio): View the live screen in the web browser by zooming in or out, while maintaining the aspect ratio of the camera image.</li> </ul>
 Capture	Capture and save the live screen as a PNG image file. A captured image file is saved in the default recording path of each browser.
 Record	You can record and save the live screen to a PC. Click the Record icon to start recording; click the icon again to stop recording. Recorded files are saved in .avi format and can be saved in the default path of the browser or a file path can be set in the 'Save as' window. To protect your video files with password, select ZIP from the list of the video recording file format and enter a password. You need to enter the password to play back downloaded videos. The password setup function for recorded videos is not available in some camera models.
 Pixel count	You can check the number of image pixels in an area selected by the mouse on the live screen. Click the Pixel count icon and click and drag the desired area with the mouse. The selected area will be displayed and the number of pixels in the image will be displayed. When you click the Pixel count icon again, the Pixel count function ends.
 Microphone	Use the microphone function. To use the microphone function, the [Audio in] function should be activated for the relevant profile. To activate the audio input function, select [Enable] from [Setup]>[Basic]>[Video profile]>[Audio in].
 Alarm output	When you click a desired alarm output number, the alarm will be outputted as previously set. The alarm can be set from the [Setup]>[Event]>[Alarm I/O] page. The number of alarm outputs varies depending on the camera.



Icon	Description of function
 Speaker	Adjust the audio volume of the live screen.  Click the icon to activate the audio and adjust the volume.
 Audio play/Audio stop	You can play or stop an audio clip of your choice after selecting it from the audio clip list. You can play audio of your choice while monitoring the live video. Go to [Setup]>[Video & Audio]>[Audio setup]>[Audio clip] to register an audio clip.

### To capture image

- In the scene to capture, click the capture icon().
- When the captured image is saved, a notification message will pop up. The capture image is saved to the path specified in each browser.

If image capture does not work in Windows 7 or later with the Internet Explorer browser, run the Internet Explorer browser as administrator.

### To record video

- Click the Record icon().
- To end the manual recording, click the Record icon() again.



The manual recording can be saved as an .avi file in your PC. Specify the path and save the video.

To protect video recordings with password

- Select ZIP from the list and enter a password.

Your video recordings will be saved as .zip in your PC. You need to enter the password to play back the videos. (The password setup function for recorded videos is not available in some camera models.)

### To switch to full screen

- Select the Full screen icon() to change the viewer mode to full screen.
- To exit the full screen mode, click the Full screen icon() again or the [Esc] key on the keyboard.

### To use microphone

- Click the microphone icon().

If no sound is heard when connecting or disconnecting the audio jack from the PC while playing the audio, click the microphone icon() and enable it.

The sound output from the camera may be inconsistent depending on the microphone device settings. If the sound is not well heard, turn off the improvement function of the microphone properties in the PC where the web viewer is operating, or adjust the microphone device volume.

### To use speaker

- Click the Speaker icon().

### To count the number of pixels

- Click the Pixel count icon().
- Drag the mouse over the video to set an area. From this area, the number of pixels will be counted and displayed on the screen.

### To play an audio clip

- Click the Play icon (▶) after selecting an audio clip of your choice from the audio clip list.
- To stop playing it, click the Stop icon (■).

## Video setup

### Profile

The name and detailed information of the Video profile applied to the current live screen will be displayed. When you press the [Profile] drop-down icon, a Video profile list that can be used from the current web viewer will appear; when you select the desired Video profile, it will be applied to the live screen immediately. You can check the resolution, codec, frame rate and target bitrate of the selected Video profile.

### Display

Set the contrast, brightness, sharpness and color level of the live screen; when you enter the setting, it will be applied to the live screen immediately. Click the ⌂ button if you want to reset all the display settings.

## PTZ

You can control Pan/Tilt/Zoom operation of the camera or move to a preset PTZ position and control group motion.

### **i** Note

- The PTZ function is available only when [Digital PTZ Profile] is selected in [Setup] > [Basic] > [Video profile] > [Profile type].
- Expand the camera image by clicking the ⊕ icon on the PTZ control screen and then you can adjust the camera views by clicking and dragging the ⊕ icon.
- When you click the 🔄 icon, a moving object on the screen will be tracked automatically. When you click the icon again, auto tracking will stop.

### Preset

Select a preset number and click the [Go] button to move the camera view to the PTZ preset position.

Select a desired preset number from the preset list and click the [Go] button to move to the desired preset position. To add a preset, click the [Set] button, enter a preset name, set its number, and then click the [Apply] button. You can also add or modify the preset list from [Setup] > [PTZ] > [Digital PTZ] > [Preset] tab.

### Group

Select a desired group number from the group list and click the [Start] button to activate the group operation. To stop the group operation, click the [Stop] button. The group list can be added or modified in the [Setup] > [PTZ] > [Digital PTZ] > [Group] tab.

### Status

#### Profile access

Check the connection status of all currently-set profiles or check the status of currently-connected users.

#### Current users

You can check the applied profile for each user, bitrate (kbps), network connection status and IP address of all users currently connected to the camera.

EST.

1998





## Playback screen

You can import and playback a recorded image from an SD card (or microSD card) or NAS.

When you click the  button on the screen, the recorded screen will appear. A time bar will appear at the bottom of the playback screen and an image recorded according to the set schedule or by an event is displayed on the time bar. You can search for a recorded image by event type or date, and capture or save it to a PC.

You can move to the live screen, playback screen or setup screen by clicking the buttons at the top.









-  (Live): Check the live image being captured by the camera and control various camera functions.
-  (Playback): Search and playback a recorded image from an SD card (or microSD card) or NAS.
-  (Setup): Change the camera settings.

### Note

- A video needs to be recorded first on the [Live] page before being able to play it.
- If there is no connection to an SD card (or microSD card) or NAS, the playback function cannot be used.
- Connecting to the web viewer via Chrome, the record playback screen feature can be securely used.

### Playback icons

The icons at the bottom of the playback screen provide the following functions:

Icon	Description of function
 Full screen	View the playback in full screen. To return to the previous size, click the  icon in full screen mode or press the [Esc] key on the keyboard.
 Size option	<ul style="list-style-type: none"> <li>• The size changes to the next size each time you click it.</li> <li>•  (Fit): View the camera image in the same size as the web browser viewing window.</li> <li>•  (Original Size): View the camera image at its actual resolution.</li> <li>•  (Aspect Ratio): View the playback screen in the web browser by zooming in or out while maintaining the aspect ratio of the camera image.</li> </ul>
 Capture	Capture and save a recorded image as a PNG image file. A captured image file is saved in the default recording path of each browser.
 Prev	Move to the previous frame.

Icon	Description of function
▶ /    Playback/Pause	Playback or pause an image.
▶   Next	Move to the next frame.
Playback speed	Set the playback speed of the screen.
🔊 Speaker	Adjust the audio volume of the playback screen. 🔊 Click the button to activate the audio and adjust the volume.

### Playback a recorded image through event search

You can search for a recorded image by event type. Also, if the time on the camera system has been adjusted and thus resulted in overlapping time, the video recorded during that overlapping hour can be searched.

#### To search by event and play back

1. Click the Show button on the Playback screen. If there is any video taken on the day of searching, it will be displayed on the time bar.
2. To search by event type, click the [All] button at the top of the time bar and select an event you want.
3. To search for recorded images during the overlapped time, select an overlapped section.
4. Click the [Apply] button to display the searched events on the time bar.
5. Click the Playback button.
6. To stop the playback, click the Pause button.

### Playback a recorded image through time search

Search for a recorded image by selecting a date and time on the calendar. When you click the [Today] button on the time bar, only images recorded today will be searched.

#### To search by time and play back

1. Click the Show button on the Playback screen. If there is any video taken on the day of searching, it will be displayed on the time bar.
2. Click a date on the time bar, select the date you want on the calendar, and set the start and end time.
  - When you select [All day], the start and end time will be set automatically from 00:00:00 to 23:59:59.
3. Click the [Apply] button.
4. Click the Playback button. The video of the selected time will play back.
  - If the video is already playing, the recorded time of the current video is displayed.
  - You can rewind or fast-forward the video and change the playback speed as necessary.
  - Click the left arrow button to go back by 1 frame. Click the right arrow button to go forward by 1 frame.
  - Click the Playback speed button to change the speed to 1x, 2x, 4x, 8x, -1x, -2x, -4x, or -8x. As the speed changes, you can set the desired playback speed.
  - Move the button along the time bar to play back the video of the desired time.

## Recorded video save

Recorded videos can be saved to files.

### To save a video

1. Click the [Export] button.
2. In [Time], set the Start time and End time for the video to save.
3. From [Type], select the file type you want.
  - AVI: Saves in .avi.
  - ZIP: Saves in .zip. You can set a password for your files. You need to enter this password to unzip those files in order to play videos. (The password setup function for recorded videos is not available in some camera models.)
4. Click the [Apply] button.

EST.

1998

WE SECURE YOUR LIFE



## Video profile

The user can add or delete a video profile, and change the profile properties. Set the video profile, frame rate and codec as 'Video profile' in advance and later change the video profile to stream or play back an image. When you finish the setting, click the [Apply] button at the bottom of the page.

### Video profile connection policy

After profile properties have been changed, you can set whether to output an image with the previous profile or with the changed profile.

When [Keep connection when Profile properties are changed] is selected, the image is outputted according to the previous profile properties even if the profile properties have been changed; when the web viewer is reconnected, the image is outputted with the changed profile. Border lines will appear on the edge of the live view of the [Live] screen until you connect to the web viewer again after changing the profile properties. [Keep connection when Profile properties are changed] is not selected, the image is outputted with the changed profile immediately when the profile properties are changed.

### Video profile

The user can select a video profile according to the service environment and circumstances of product use. In addition to the profiles provided by default, the user can add a new profile or delete an existing one. You can set the codec, profile type, resolution, frame rate, multicast, and other settings for each profile.

#### Profile list

The profile list is provided by default; all profiles added by the user are also displayed.

#### Adding a video profile

1. Click the [Add] button. A new item will be added to the profile list.
2. Enter the name of profile in the [Name] field. The entered name will appear in the profile list.
3. Set the profile items, including [Codec], [Profile type] and [Resolution].
4. Click the [Apply] button at the bottom of the page.
5. When the confirm window appears, click the [OK] button. The new profile will be added.

#### Changing a video profile property

1. Select the profile which you wish to change from the profile list.
2. Change the relative settings, including [Codec], [Profile type] and [Resolution].
3. Click the [Apply] button at the bottom of the page.
4. When the confirm window appears, click the [OK] button. The settings of the selected profile will change.

#### Deleting a video profile

1. Select the profile which you wish to delete from the profile list.
2. Click the [Delete] button.

3. When the confirm window appears, click the [OK] button. The selected profile will be deleted.

### Name

The name of the profile selected from the profile list will be displayed. You can enter a new profile name if creating a new profile.

### Codec

Select the codec which you wish to apply to the profile. The profile properties may vary according to the selected codec type.

### Profile type

Select a profile type to apply. The selected profile type will be displayed in the [Type] column of the profile list. The setup items may vary according to the selected codec type.

- Default profile: This is the default profile applied for streaming a live camera image. 'Default' is displayed in [Type] in the profile list.
- E-mail/FTP profile: This video profile is used for sending the captured screen of an image when an event is created. 'Event' is displayed in [Type] in the profile list. The E-mail/FTP profile option will appear only when MJPEG is set for the codec.
- Edge recording profile: This profile is applied for recording an image on an SD card or NAS. 'Record' is displayed in [Type] in the profile list.
- Digital PTZ profile: This profile is used for controlling PTZ motions. 'DPTZ' is displayed in [Type] in the profile list. The Digital PTZ profile option will appear only when H.264 or H.265 is set for the codec.
- Frame Lock profile: This is a profile applied to guarantee a certain level of video frame rate. 'FrameLock' is displayed in [Type] in the profile list. This 'Frame Lock profile' option appears only when [Codec] is set to [h.264] or [h.265].

### Audio in

When the camera has an internal microphone or an external microphone is connected, you can set external sounds to be inputted in the image.

To use the Microphone and Speaker functions on the Live page, [Enable] should be selected for [Audio in].

### Crop encoding

Crop encoding crops only a selected portion from the full screen and displays it according to the resolution set in the [Profile properties]. Only a resolution size smaller than the Crop encoding setting area can be set. To apply crop encoding to the current profile, select [Enable].

#### Setting a crop area

1. Set [Enable] for crop encoding and click the [Set area] button.
2. Set the area by dragging the mouse on the [Set crop area] preview screen. After selecting [Manual], select the area you want.
3. To complete the area setting, click the [OK] button.

### **i** Note

- If [Crop area setting] is set to a range you desire, the resolution that is most similar to the output resolution within the range set by you will be displayed.
- If you change the setting under [Video & Audio]>[Camera setup]>[Special]>[DIS], the crop area setting may change. If you have changed the DIS setting, please set the Crop encoding area again.

## Profile properties

Set the details for the current video profile.

### Resolution

Set the resolution of the camera image.

### **i** Note

- In order to stream a high-resolution image smoothly, it is recommended to connect to the web viewer using Google Chrome.

### Frame rate

Set the number of frames per second.

The range of frame rates available varies according to the frame rate value selected from [Video & Audio]>[Camera setup]>[Sensor].

### Compression

You can set the compression ratio.

### Maximum bitrate

Set the maximum bitrate of the image when [Bitrate control] is [VBR].

### Target bitrate

Fix the amount of image data to be sent if [Bitrate control] is [CBR].

## Advanced

If either [H.264] or [H.265] is set for [Codec] of the profile, all advanced setup items will be displayed. If [MJPEG] is selected for [Codec] of the profile, only the [Encoding priority] item will be displayed.

### Bitrate control

Set how to adjust the amount of image data.

- CBR: Constant Bitrate is for sending full-frame data of a constant size. When CBR is selected, the size of data to be sent is set by setting the target bitrate. CBR has a constant data size, making it is easy to predict the data size for the whole system, enabling the system to be operated stably.

- VBR: Variable Bitrate is for sending an image within the maximum bitrate without fixing the data size of the frame. VBR can use storage space capacity or bandwidth efficiently while maintaining the quality, but if an image suddenly becomes more complex, it may cause a strain on the network.

#### **i** Note

- When the Bitrate control is set to 'CBR (fixed bitrate)' and the priority on image quality mode is selected, the actually transferred frame rate may be different from the set frame rate in order to guarantee the best image quality under the set bitrate in consideration of the complexity on screen.

### Video compression

You can set the video compression ratio. [Profile properties] has the option of a [Compression] CBR. This is a function that sets the priority of encoding, which affects the amount of data transmission and video quality based on the video compression rate for VBR action.

The higher the value of [Video compression], the better the video compression rate. As the video compression rate increases, the amount of video data transmission decreases, but the video quality might be degraded as a result. If the video compression rate is lowered by setting a low value to [Video compression], the video quality improves, but the amount of video transmission could increase. If either [H.264] or [H.265] is selected for [Codec] of the profile, [Video compression] is activated only when [VBR] is set for [Bitrate control].

### Encoding priority

Set the priority between frame rate and image quality if the amount of image data exceeds the target bitrate.

If either [H.264] or [H.265] is selected for [Codec] of the profile, the user can select between [Frame rate] and [Compression]. If [Frame rate] is set as the high priority, the maximum frame rate is secured, but the image quality may be lowered. On the other hand, when [Compression] is set as the high priority, the image quality is secured, but some frames may be omitted, so that the image may be disconnected or seem unnatural. If either [H.264] or [H.265] is selected for [Codec] of the profile, [Encoding priority] is activated only when [CBR] is set for [Bitrate control].

If [Codec] of the profile is [MJPEG], you can select between [Frame rate] and [Bitrate].

### GOV length

GOV (Group of Video) is a group of image frames for H.264/H.265 video compression; it means the group of frames from one I-frame to the next I-frame. GOV contains both I-frame and P-frame. I-frame is the frame which becomes the basis of compression (also called the key frame); it has data for one complete image. P-frame has information of the changed area only, based on the front frame. For this reason, the number of I-frames is fewer as the GOV length is longer, making the image size small, while the number of I-frames is more as the GOV length becomes shorter, making for a larger image size. The maximum value of the GOV length varies according to the [Frame rate] in [Profile properties].

If H.264 or H.265 codec is selected for the recording file, GOV length becomes  $\text{framerate}/2$ .

## Profile

This menu becomes active only when the codec of the profile is H.264. The profile can be considered as a bundle of various compression technologies. The profiles supported in the Hanwha Techwin cameras include [Baseline], [Main] and [High]. The compression performance becomes higher and the quality becomes better as you move from Baseline to High, but a lot of system resources are used for compressing and decompressing and may create a strain on the playback equipment.

## Entropy coding

Set the type to reduce compression loss.

Two entropy coding types, CAVLC (Context Adaptive Variable Length Coding) and CABAC (Context Adaptive Binary Arithmetic Coding), are provided. However, only CAVLC coding type is available for the Baseline profile.

- CABAC: The CABAC data processing procedure is more complicated than CAVLC, so that it uses more system resources, but it has an excellent compression rate.
- CAVLC: The data processing procedure for CAVLC is simpler than CABAC, so that it uses fewer system resources, but the compression rate is relatively low.

## Smart codec

Set whether or not to use smart codec. Smart codec is a unique technology of Hanwha Techwin that reduces the compression rate for an area of interest to the user (to output in high quality), while it increases the compression rate for other areas, (to output in normal quality), thereby reducing the data size of the image as a whole. Smart codec is activated only when [Bitrate control] is [CBR].

The area for smart codec can be set from [Video & Audio]>[Smart codec].

## Dynamic GOV

To apply the Dynamic GOV function to the current profile, select [Enable].

Dynamic GOV is the function whereby the GOV length is changed automatically according to the image situation. In a video where little or no motion is detected, GOV operates based on the value set for [Dynamic GOV] by user, decreasing the bitrate of the whole video. Once motion is detected, I-frame is displayed immediately. Then, until the motion is not detected anymore, GOV operates based on the value set for [GOV length].

- Enter the maximum GOV length to apply when there is no motion in the image. The range of input value is displayed next to [GOV length]. The input value in [GOV length] becomes the minimum value, while the maximum value is 480; it varies according to the [Frame rate] in [Profile properties].

### **i** Note

- When the WiseStream function is used, if the dynamic GOV and dynamic FPS functions are used, the WiseStream performance is optimized. The WiseStream can be set in the [Video & Audio] > [WiseStream] menu.
- Dynamic GOV is enabled only when [Bitrate control] is set to [VBR]. If [Profile type] is set to [Edge recording profile], Dynamic GOV cannot be used.

## Dynamic FPS

Select [Enable] to apply the Dynamic FPS function to the profile currently being set. Dynamic FPS is a function that automatically changes FPS settings, from the minimum FPS setting to frame rate setting depending on the screen situation. In a nearly motionless video, FPS will function using the minimum FPS setting, which in turn reduces the overall screen bitrate. When a motion is detected, FPS will use an increased FPS value.

### Minimum FPS

Enter the minimum FPS value to be applied when Dynamic FPS is enabled. The [Minimum FPS] option is not displayed if the Minimum FPS value is set as 1.

#### **i** Note

- When the WiseStream function is used, if the dynamic GOV and dynamic FPS functions are used, the WiseStream performance is optimized. The WiseStream can be set in the [Video & Audio] > [WiseStream] menu.
- Dynamic FPS is enabled only when [Codec] is set to [H.264] or [H.265] and [Bitrate control] is set to [VBR]. If [Profile type] is set to [Edge recording profile], Dynamic GOV cannot be used.

### Multicast

Multicast is the method used to send data in one instance from the camera to multiple pieces of equipment. Set whether or not to use RTSP (Real Time Streaming Protocol) on the current profile and enter the detailed information.

#### Multicast (RTSP)

To send an image by using RTSP, select [Enable].

#### IP address

Enter an IPv4 address that can be connected from the IPv4 network. The range of multicast IP address is anywhere between 224.0.0.0 and 239.255.255.254. However, 255 cannot be used at the end.

#### Port

Set the port that controls sending of the image. The range of multicast RTSP ports is from 1024 to 65534, and only even numbers are allowed. (The 3702 port however, cannot be used.)

#### TTL

You can set the TTL of the RTSP packet. A value between 0 and 255 can be entered for the TTL value.

## User

Manages the user accounts connecting to the camera. Changing of the administrator password and guest settings, authentication setup and setting of current users are all available. When you finish the setting, click the [Apply] button at the bottom of the page.

**Change administrator info** You can change the administrator account ID and password. To reinforce security, create a password by combining random English uppercase and lowercase letters, numbers and special characters. You can change the administrator password. To reinforce security, create a password by combining random English uppercase and lowercase letters, numbers and special characters.

### ID

You can view or change the administrator ID that is currently used.

#### **i** Note

- Administrator ID must contain only alphanumeric characters with a maximum length of 8 characters.
- The default guest ID "guest" or the default user ID "user1", "user2"... "user10" cannot be used as the administrator ID.

### Current password

Enter the current password. To prevent the password from being changed by someone else, the administrator password can be changed only after entering the previous password.

### New password

Enter a new password.

### Confirm new password

This is the confirmation procedure to prevent incorrect input of a new password. Enter the new password again.

#### **i** Note

- To reinforce security, it is recommended to create a password by combining special characters, numbers, and uppercase and lowercase letters.
- It is recommended to change the password every three months.
- The password length and restrictions are as follows:
  - For password of 8 to 9 digits, you need to combine at least three different types of the following: uppercase and lowercase alphabets, numbers, and special characters.

- For password of 10 to 15 digits, you need to combine at least two different types of the following: uppercase and lowercase alphabets, numbers, and special characters.
- Password must be different from your ID. Also, we recommend not to use your ID string as part of the password.
- You cannot use four or more consecutive characters (e.g. 1234, abcd).
- You cannot use the same character four or more times in a row (e.g. !!!!, 1111, aaaa).
- Only ~!@#\$\$%^\*()\_-=+|{}[].?/ are allowed for special characters.
- After the factory reset, both the admin and user passwords will reset, and you need to create them again.
- When you access the camera web viewer for the first time, or access it after the initialization, you will be moved to the password setting menu.
- To use the web viewer menu, you need to set the new password in the password change menu and log in to the web viewer again with the changed password.
- When changing the admin password, if the current password is not matched, then you cannot set the new password.
- After changing the password, if there is a camera connected to a client, such as CMS or NVR, then you need to register the changed password before use. If you maintain the same connection, the client will use the previous password for authentication, so the account can be locked.
- When logging in to the web viewer, if you entered incorrect password more than five times, it will be locked for 30 seconds and you won't be able to access the web viewer.
- If connection is made from various places with the same ID, or the password is changed while a number of Internet browsers are open, the Internet browsers may malfunction. It is recommended that a password be changed only from one location or only through one Internet browser.

### Guest settings

When you select [Allow guest access], a guest can connect to a web viewer screen. When you connect with a guest account, you can see only the live screen on the web viewer. Guest ID and password are 'guest/guest' and these cannot be changed.

### Authentication setup

When you select [Allow RTSP connection without authentication], you can access the camera video using RTSP (Real Time Streaming Protocol) without the login authentication.

### Current users

You can set the connection information for user accounts other than the administrator, and set use permissions including audio in, audio out, alarm output and profile. When a registered user logs in, only the functions set for that user are enabled. 10 current user accounts are set by default; you can add or delete an account. Up to 10 current IP user accounts can be used.

#### **i** Note

- If you want to select the configured user that can use ONVIF, the use of the function may be restricted depending on the permission level set.

### Use

Select the check box to enable the selected user account.

## Name

Enter the ID

## Password

Enter the password. The password setting rule is same as the administrator password setting rule.

## Admin privilege

Authorize the selected users with admin privileges. Normal users can use only functions that their administrator allowed, but administrators can access and set any functions they want. However, even if admin privileges are given to users, they cannot change their admin ID or password.

## Audio in

Set the permission for accessing the inputted audio. If audio in is selected, a user who connects to the relevant account can watch the screen and listen to audio at the same time; if audio in is not selected, the user can watch only the image screen.

## Audio out

Set audio out permissions. When audio out is selected, a user who connects to a relevant account can send audio through the microphone.

## Alarm output

Set alarm output permissions. When an alarm has been set, a user who connects to a relevant account can output the alarm.

## Profile

When [Default] is set, the user can watch the image only in default mode; when [All] is set, the user can watch the image in all profiles.

### Inputting a current user

1. Select the radio button of the current user account you wish to use. The current user account is changed to a status where input is available.
2. Select the check box in the [Use] column.
3. Enter the ID and password in the [Name] and [Password] columns.
4. Select a function to allow in the [Audio in], [Audio out] and [Alarm output] columns respectively, and select the type of profile to allow in the [Profile] column.
5. When the input of the current user account is completed, click the [Apply] button at the bottom of the page.
6. When the confirm window appears, click the [OK] button.

### **i** Note

- If the number of current user accounts is less than 10, you can add a current user account by clicking the [Add] button.

### Modifying a current user

1. Select the radio button of the current user account you wish to modify.
2. Change the function settings and click the [Apply] button at the bottom of the page.
3. When the confirm window appears, click the [OK] button. The information of the user will be changed.

### Deleting a current user

1. Select the radio button of the current user account you wish to delete and click the [Delete] button.
2. Click the [Apply] button at the bottom of the page.
3. When the confirm window appears, click the [OK] button. The information of the selected current user will be deleted.

EST.



1998

WE SECURE YOUR LIFE



## Date & Time

You can check the current system time of the camera, change the time setting according to the local time zone, or set the system time through synchronization with an NTP server.

---

**Current system time** The current system time of the camera is displayed. The previously set system time is displayed.

---

**Time zone** The camera time is set based on standard time (GMT).

### Time zone

Select the desired time zone and click the [Apply] button below.

### Daylight saving time

When an area where daylight saving time is used is selected, the [Daylight saving time] menu will be displayed. The start and end time for daylight saving time in the selected time zone are displayed. When [Enable] is selected for [Daylight saving time], a time which is one hour ahead of the standard time of the relevant zone is displayed.

#### **i** Note

- Only when [Daylight saving time] is set to [Enable] will the time appearing on the timeline of the playback screen be displayed according to daylight saving time.
- If the clock function of the PC is set to automatically apply daylight saving time, the daylight saving time option is automatically selected in the camera web viewer, and cannot be changed by the user.

---

**System time setup** The user can set the camera time manually or by synchronizing it with an NTP server. When you complete the setting, click the [Apply] button at the bottom of the page.

---

### Manual

The user can enter the current time manually for the camera or synchronize it with the time of the PC with which it is currently being used.

- Set the system time by entering the time in [Y - M - D] and [h: m: s].
- When [Synchronize with PC viewer] is selected, the time of the PC viewer is synchronized with the system time. When [Synchronize with PC viewer] is selected, the same time zone should be separately set for both the PC and the camera.

# COLLSAM SECURITY

## Synchronize with NTP server

The NTP (Network Time Protocol) server time is synchronized with the system time. 5 NTP server addresses are entered by default. You can change an NTP server address by clicking the address input field.

EST.

1998

WE SECURE YOUR LIFE



## IP & Port

Enter IP address and port. You can set IPv4 and IPv6 on the [IP address] tab. You can set the port for each protocol on the [Port] tab. When you finish the setting, click the [Apply] button at the bottom of the page. When you click the [Apply] button, you will need to reconnect to the web viewer.

### IPv4 setup

You can check or change the IP type, MAC address, IP address, subnet mask, gateway, and DNS information used for the network communication using the IPv4 type.

#### IP type

Select the IP connection type. If a fixed IP address is used, set [Manual] and enter the information. If a dynamic IP is used, set [DHCP] and enter the DNS address only.

- Manual: Enter and set the IP address, subnet mask, gateway, DNS1 and DNS2 directly.
- DHCP: Set DNS1 and DNS2.

#### MAC address

The MAC address of the camera is displayed.

#### IP address

The current IPv4 address is displayed. You can change the IP address by setting [Manual] for [IP type].

#### Subnet mask

The subnet mask of the current IP address is displayed. You can change the subnet mask by setting [Manual] for [IP type].

#### Gateway

The gateway of the current IP address is displayed. You can change the gateway by setting [Manual] for [IP type].

#### DNS setting by DHCP

This is displayed when [DHCP] is set for [IP type]. If you select Enable, the DNS address is automatically assigned.

#### DNS1/DNS2

The address of the DNS (Domain Name Service) server is displayed.

## Host name

Host name is the name to retrieve the host name which is used in ONVIF GetHostname command. The first character must be alphabetic and only alphanumeric characters can be entered. Up to 63 characters can be entered. Name of the camera is input as default; does not need to be set as it is not a required value.

## MTU

Set the maximum transmission unit (MTU) at which data can be transferred from the network interface. The MTU value can be set from 1280 octets to 1500 octets. If the value is set too low, the video playback may be delayed. Therefore, the MTU value should be set according to the user's network environment.

## IPv6 setup

IPv6 is a next-generation Internet address system with data processing speed, concurrent data processing capacity and Internet address system which are more expanded than IPv4. To use IPv6, select [Enable]. You can set the IP type, IP address, Prefix and gateway. When you select a camera model from the IP installer, you can select either IPv4 or IPv6 address and connect by entering the appropriate address directly in the web browser.

### IP type

Select the IP connection type. The default value is [Default]. If DHCP is not detected, the value will automatically be changed to the previous setting.

- DHCP: The IPv6 address assigned through DHCP is displayed.
- Manual: The user can enter an IPv6 address of choice.
- Default: The current IPv6 address is displayed.

#### **i** Note

- After changing the setting, click the [Apply] button to close the web browser window. After a moment, access the changed IP address again.

### IP address

Enter the IPv6 address.

### Prefix

This value sets the IP range. If [IP type] is [Default], [Prefix] value is 64. If it is [Manual], you can change the [Prefix] value.

### Gateway

Gateway is displayed when [Manual] is set for [IP type]. The user enters the gateway address directly.

## Port

A port is the location used for sending and receiving data. Click [Port] tab, set the relevant items, and then click the [Apply] button at the bottom of the page. It is recommended to use HTTPS and RTSP to reinforce image security.

### Note

- When setting the port number, you cannot use 3702, 4520, 49152 or any number between 0 and 1023.

### HTTP

The HTTP port is used for connecting to the camera using a web browser. The default value is 80 (TCP). When the HTTP port is changed, the web browser window will be closed. Enter the new HTTP port at the end of the IP address to reconnect. If the HTTP port is 80, the port number can be omitted. (e.g.: Camera IP address: 192.168.1.100, HTTP port In case of 8080 -> http://192.168.1.100:8080)

### HTTPS

HTTPS has increased security over HTTP. This can be used when HTTPS mode is set in SSL, and the default value is 443 (TCP). The available range is between 1024 and 65535.

### RTSP

This is the port for sending an image in RTSP (Real Time Streaming Protocol); the default value is 554.

### Timeout

To use the timeout, select [Enable]. If there is no response for a certain period of time when connection is made in RTSP, reset the port connection.

## Digital PTZ

You can set the camera views to move after digital zoom is executed, rather than having the camera view change by physically moving the camera up and down (tilt) or left and right (pan). You can set a preset or change the camera views by setting a group of presets. When you complete the setting, click the [Apply] button at the bottom of the page.



### **i** Note

- [Digital PTZ profile] should be selected from [Video profile]>[Profile type] in order to set digital PTZ.

## Adjusting the PTZ

You can adjust the pan, tilt, and zoom actions of the camera.





### Adjusting the PTZ

- When you drag the icon  with the mouse, the camera moves to the pan and tilt.
- Select an image magnification by clicking the icon  to zoom the screen in or clicking the icon  to zoom the screen out from the zoom bar.

## Preset

Preset means the setting of the camera views. 128 presets can be set.

### Setting a preset

1. Expand the camera image by clicking the icon  on the PTZ control screen, and then
  - adjust the camera views by clicking and dragging the icon .
  - select an image magnification by adjusting the zoom bar, or click the icon  to zoom the screen in or click the icon  to zoom the screen out.
2. Select a preset number from [Number].
3. Enter the relevant preset name in [Name].
4. Click the [Add] button.

When you click the icon , a moving object on the screen will be tracked automatically. When you click the button again, auto tracking will stop.

### Moving to a preset

1. Select a preset number from [Number].
2. When you click the [Go] button, the camera views will move to the set location.

### Deleting a preset

1. Select the preset number you wish to delete from [Number].
2. When you click the [Remove] button, the preset will be deleted.

## Group

You can group a number of presets and access presets placed in a group sequentially.

### Setting a group

1. Select a group number from [Group No.].
2. Click the [Add] button in [Preset list]. When the preset list is displayed, select a number from [Preset No.] and enter the length of time (in seconds) to stay in the relevant preset in [Dwell time].
3. Enter two or more preset numbers by repeating step No. 2.
4. When you complete the setting, click the [Apply] button at the bottom of the page.

### Running a group

1. Select a group you wish to run from [Group No.].
2. When you click the [Start] button, the presets for the relevant group will change according to the dwell time.
3. When you click the [Stop] button, the presets running as a group will stop.

### Deleting a group

1. Select a group you wish to delete from [Group No.].
2. When you click the [Remove] button, the group will be deleted.

EST.

1998

WE SECURE YOUR LIFE



## Video setup

You can set a privacy area in the camera's image or flip it in reverse directions (vertically or horizontally). Once you have completed the setting, click the [Apply] button at the bottom of the page.

### Privacy area

To prevent a possibility of privacy invasion in the camera's image, you can set a privacy area. To use the privacy area function, click [Enable privacy area]. To deactivate a privacy area, deselect [Enable privacy area], then you can check the full camera's image without anything hidden due to privacy. The set privacy areas are not deleted and they can be checked in the privacy area list.

#### Pattern

Select the mosaic pattern to apply to a privacy area. Select [Solid] to apply the color set in the privacy area window. If you select the pattern, it will be applied to all the areas.

#### Setting a privacy area (except for a zoom or PTZ camera)

1. Select [Enable privacy area] and click the [Apply] button at the bottom of the page.
2. Click on 4 corners with the mouse on the camera video screen.
3. In the [Privacy area] window, set the following:
  - Enter the name of the privacy area in [Name], select the color to cover the image in [Color].
4. In the [Privacy area] window, click the [OK] button.
5. A new privacy area is added to the list of privacy areas. The color set in the camera's image screen is used to display a privacy area.

#### **i** Note

- Only English letters, numbers, dash (-) and period (.) can be entered for the name of a privacy area.

#### Deleting a privacy area

1. Select a privacy area to delete from the list of privacy areas. The selected area is displayed on the camera's image screen.
2. Click the [Delete] button. The selected area will be deleted.

### Video rotation

If the screen is displayed upside down after installing the camera, you can correct this through the flip mode and mirror mode functions.

The [Hallway view] feature provides a long vertical view of the screen which allows the user to operate the surveillance area more efficiently in a corridor or alley.

#### **i** Note

- If you change the video rotation setting, the video will be flipped in four directions or changed. To help you analyzing the changed video and accumulate the statistics, change the analysis and statistics setting. The settings can be changed in the [Analytics] and [Statistics] menus.

### Flip

You can flip the camera image upside down. To flip the camera image, select [On].

### Mirror

You can mirror the camera image. To mirror the camera image, select [On].

### Hallway view

By rotating the camera image in an environment where a general camera cannot properly monitor the narrow aisles or hallways, you can magnify the vertical monitoring areas. You can rotate it 90 deg (Clockwise) or 270 deg (Clockwise) or set it to 0 deg to return to the original image.

#### **i** Note

- In order to set the hallway view, you need to set the installed camera to 0 degree, or rotate to 90 degrees clockwise or 270 degrees clockwise, and select the same angle in [Hallway view].
- When you set [Hallway view], the web browser will close automatically. You will need to reconnect to the web viewer.

## Video output

You can select the method of displaying camera video output.

### USB

To display a camera image by using the USB, click [Enable].

Using the Wi-Fi dongle and smartphone app from Hanwha Techwin, you can access your camera over Wi-Fi. This is useful when you are trying to install a network camera for the first time or change the angular field of view or position of your camera, since you can see the camera screen on your smartphone without the hassle of getting an additional monitor to check the installation.

### CVBS

To display a video by connecting a cable to the CVBS terminal, click [Enable].

It is useful since you can set it while checking the lens position or focus when installing the camera.

### CVBS type

To use CVBS, select the CVBS video output type.

- NTSC: NTSC (National Television System Committee) is the US standard for color TVs. The number of frames per sec is 30 and the number of horizontal projection

beam is 525, Since the number of frames per sec is high, the screen looks very natural. It is mostly used in USA, Japan, and Canada.

- PAL: PAL (Phase Alternation Line) method was proposed by Germany and it is similar to NTSC but differs in the way it handles the color signals. It is mostly used in Europe. Compared to NTSC, the number of frames per sec is lower but the number of horizontal beams is higher (625). Thus, the resolution is higher, the color deformation is less, and the broadcasting facility does not require high specifications.

**i Note**

- To prevent degradation of the camera performance, turn off the video output function after installing a camera.

EST.



1998

WE SECURE YOUR LIFE

## Audio setup

You can connect a microphone and speaker to a network camera and listen to the sound at a remote location where the camera is installed, or output audio from the camera to the location. When you complete the setting, click the [Apply] button at the bottom of the page.

### Audio in

You can input audio into an image through a microphone connected to the camera. Input audio by selecting a source that fits the usage environment.

#### Source

Select an alarm input type.

- Internal microphone: This is the internal microphone included with the camera.
- External microphone: An external microphone can be connected to the camera and used instead of the internal microphone. When you select [Apply power to Ext. Mic.], the camera supplies power to an external microphone.
- Line: Connect to sound equipment through a cable. For example, connect sound equipment such as an MP3 player and a camera through a cable, and select the MP3 player when you input recorded audio from it into the camera.

#### Codec

Select an audio codec.

- G.711: This is the standard audio codec for ITU-T, which is mainly used in telephone communication; the audio quality is low. It is also called the pulse code modulation of sound frequency; soundwaves can be delivered digitally in PSTN or through PBX.
- G.726: This is the standard audio codec for ITU-T, which is mainly used in telephone communication; the audio quality is low. It is possible to change and compress 64 Kbps PCM to 16, 24, 32 or 40 Kbps through Adaptive Differential Pulse Code Modulation (ADPCM).
- AAC: AAC (Advanced Audio Coding) is the international standard that succeeds MP3. It is more efficient than MP3 and has sound quality similar to an original copy of a CD. AAC enables the use of audio of a higher sampling rate than is the case when using the previous G.711 and G.726 codecs.

#### Note

- When an image is streamed through Firefox or Edge, the AAC codec is not supported even if the desired codec has been set in the audio setup page.

### Sampling rate

This refers to the number of samplings per second when an analog sound source is converted to a digital sound source; as this value is higher, the sound quality is better. The sampling rate is fixed for each audio codec, and cannot be changed by the user.

The sampling rate of the G.711 and G.726 codecs is 8 KHz, while the sampling rate of the AAC codec is 16 KHz.

### Bitrate

The bitrate of the G.711 codec is 64 Kbps and cannot be changed. The bitrate of the G.726 codec is 16, 24, 32 and 40 Kbps; the compression ratio can be changed. Only 48 Kbps can be selected for the AAC codec.

### Gain

Sets the amplification value of audio in. If the input sound is too low, you can increase the gain value to amplify the input audio signal. The range of gain value is from 1 to 10; a larger value means higher amplification.

### Noise reduction

Select Noise Reduction if the surrounding noise is too strong to hear the sound of interest.

Noise reduction may not work properly if noise is indistinguishable from the surrounding voice sound, or if the sound pressure is high.

- Sensitivity: You can set the noise reduction sensitivity based on the level of ambient noise.

### Audio out

You can output audio through the built-in speaker.

### Audio out

To use audio out, select [Enable].

### Gain

Sets the amplification value of audio out. If the output sound is too low, you can increase the gain value to amplify the output audio signal. The range of gain value is from 1 to 10; a larger value means a louder audio out. Gain is activated only when [Enable] is selected for audio out.

#### Note

- If an excessive audio level or gain value is set, a deterioration of sound quality or a howling sound may occur.

### Audio clip

You can register or delete an audio clip file. You can also set up the schedule to play the audio clip only at a specific time.

You need to click the [Apply] button after file registration to display the audio file in the audio clip list on the [Live] or [Event setup] page. Up to 5 audio clips can be registered within the total capacity limit of 6 MB.

After registering your audio clips, you can set a clip of your choice to be triggered by an event or play the clip by selecting it while monitoring camera video on the [Live] screen.

## Upload

Registers an audio file. Only .WAV format is supported.  
Click the [Upload] button and then select a file.

### **i** Note

- Sampling rate of 48,000 KHz or less is recommended.
- For bits per sample (bps), 8/16 bit is recommended.
- Only PCM encoding format is supported.

## Record

Recorded audio can be registered as an audio clip.

### Recording audio

1. Click the [Record] button.
2. Set the [Record] dialog box as follows:
  - Enter a name for the audio clip file in the [Name] field. Only alphanumeric characters are allowed.
  - Click the [Start] button to start audio recording.
  - To stop recording, click the [Stop] button. Then the time available for recording and the length of the recorded audio are displayed.
  - Click the [Play] button to listen to the recording.
3. In the [Record] dialog box, click the [OK] button.

### **i** Note

- This audio recording function is only available for browsers that support audio recording.
- If you see this message—"HTTP mode does not support audio recording. Please change to the HTTPS secure access mode.", then you have to access the camera web viewer using the HTTPS secure mode. To access in the secure mode, select [HTTPS (Secure connection mode using a unique certificate)] or [HTTPS(Secure connection mode using the public certificate)] in the [Network]>[HTTPS]>[Secure connection system], and then retry accessing the web viewer.

## Delete

After selecting the radio button of a clip to delete in the audio clip list, click the [Delete] button to delete the selected audio clip.

## Audio clip list

The list of registered audio clips is displayed.

To select a clip, click its radio button.

- Name: The name of the audio clip is displayed.
- Play: Clicking the Play button (▶) allows you to play and preview the audio file.
- Gain: You can set the audio output amplification value. If your sound output is not loud enough, you can raise the gain value to amplify the audio signal output. The higher the value, the louder the audio output.
- Download: You can download an audio clip file.

### Schedule

You can set the schedule for your registered audio clips to play automatically. You can set a different schedule for each audio clip.

You need to register an audio clip first to activate the Schedule option.

#### Setting the schedule for audio clip playback

1. Select an audio clip from the audio clip list to play it at a specific time.
2. Check the [Enable] box under [Schedule].
3. Specify the time to play.
  - If you want to play it daily at a specific time, select [Daily] and the specific time you want.
  - If you want to play it on a day of the week at a specific time, select [Weekly] and the specific day of the week and time you want.

EST.

1998

WE SECURE YOUR LIFE



## Camera setup

You can change the camera settings to capture the best image in the environment where the camera is installed. Image presets suitable for various environments are provided by default; the user can also specify camera settings directly. You can check on the camera preview screen how the camera image is displayed according to the settings. When you complete the setting, click the [Apply] button at the bottom of the page. If the time-out time (240 seconds) has passed without clicking the [Apply] button after changing the setting, the previous setting will be restored.

### Comparison view

You can see the videos of before and after changing camera video setting values all at once in the [Before] and [After] panels.

In the case of PTZ camera, if you click [PTZ control], a PTZ adjustment panel rather than camera video screen is shown in the place of the [Before] panel. Also, if you click [Refresh], it updates the source video in the [Before] panel with values most recently applied.

### Sensor mode

Set how many frames per second the CMOS sensor of the camera will capture.

#### **i** Note

- Changing the sensor mode will reset the whole camera setting.
- Sensor mode value cannot be set differently for each image preset. Frame rate applies identical to all image presets.
- The maximum value of [Basic]>[Video profile]>[Frame rate] varies according to the number of frames set for the sensor mode.

### Image preset mode

Various image presets are provided for specific purposes. Select an image preset that best suits your camera environment.

- User-defined preset 1: Used for displaying the image as set by the user.
- User-defined preset 2: Used for displaying the image as set by the user.
- Outdoor daytime: Used to display a clear and smooth video taken outdoor in daytime.
- Outdoor night time: Used to reduce the level of noises for video taken outdoor at night with low brightness and lighten up dark areas.
- Indoor backlight: Used to display a video where indoor and outdoor are both identifiable with indoor backlight.
- Indoor bright scenes: Used to provide clear picture quality and reduce flickering in an illuminated indoor environment.
- Number plates: Used to improve the ability to identify the license plate of a car in daytime and at night.
- Vivid video: Used to improve color and clarity.

#### Note

**i** After selecting an image preset mode, change the detailed settings of camera image, such as white balance and night/day modes, and click [Apply] to save the changed value as the image preset value. To reset it to default, click the [Reset] button.

## SSDR

SSDR increases the brightness of a dark area to reveal an image in an environment where there is a significant difference between a dark area and a bright area.

### SSDR

To use SSDR, select [Enable].

#### Level

Adjust the level of dynamic range. As the level goes higher, a dark area becomes brighter.

#### D-Range

Select the amplitude area of the dynamic range.

## White balance

You can make corrections to show the color white correctly and other colors normally, in any lighting environment.

### Mode

Select the white balance mode according to the environment where the camera is being used.

- Manual: You can adjust red gain and blue gain manually. If more red color is shown, lower the red gain, and if more blue color is shown, lower the blue gain. If more green color is shown, raise both the red and the blue values.
- ATW: Corrects the camera color automatically.
- Outdoor: The colors of the camera are corrected to be optimized for an outdoor environment.
- Indoor: Correction is made to optimize colors for an indoor environment.
- AWC: Screen correction is made to optimize the colors for the current lighting environment. When you aim the camera at white paper and press the [Set] button, the red gain and blue gain will be adjusted and applied to the image. The white balance value continues to be applied to the currently displayed video. If the environment changes, this should be adjusted again.
- Narrow ATW: Auto-corrects camera color in 2800 K ~ 9000 K environment. [ATW]The color temperature range is narrower than Mode.
- MERCURY: Screen correction is made to optimize the colors for the mercury lighting environment.
- SODIUM: Screen correction is made to optimize the colors for the sodium lighting environment.

### Red gain

Adjust the red gain. If the red gain is high, more red color is shown on the screen. If too much red is shown, lower the red gain.

### Blue gain

Adjust the blue gain. If the blue gain is high, more blue color is shown on the screen. If too much blue is shown, lower the blue gain.

#### **i** Note

- In any of the following cases, white balance may not operate normally. In such case, adjust the white balance through the [AWC] mode.
  - If the surrounding environment exceeds the color temperature correction range, such as a clear sky or sunset
  - If the surrounding environment is dark
  - If the camera faces directly toward a fluorescent light or if there is a significant illumination change.

### Backlight

An image captured against the light can be corrected. Select from among Off, BLC, HLC, or WDR in [Mode] and change the setting according to the selected backlight mode.

#### BLC

The BLC (Back Light Compensation) mode selects and corrects a specific area on a dark image captured against the light, to show an object in a selected area more clearly.

#### BLC level

Move the slide bar to adjust the BLC level. The higher the level, the brighter the set area.

#### HLC

The HLC (High Light Compensation) mode blocks strong lighting such as a streetlight or the headlights of a vehicle, to prevent failures to detect a neighboring object, such as a car license plate, due to saturation of strong lights.

#### HLC level

Set the level of exposures and adjust the highlight areas.

The higher the level, the higher the correction and the bigger the difference is for highlight-blocked area.

#### Mask

Select whether or not to apply the mask.

- Off: Does not create blocked area.
- On: Always blocks areas of brightness above a certain level.
- All day: Blocks areas except during very bright or dark time.

- Night only: Blocks areas until it gets really dark.

#### Mask color

Sets the color of the blocked area.

#### Mask tone

Sets the tone of the blocked area.

#### Dimming

Detects the strongly illuminated area on the screen and adjusts brightness to reduce the size of the saturated areas.

#### **i** Note

- At night, it only operates when the size of a highlight goes over the threshold in a dark environment.
- At night, HLC does not operate when it is overall too bright or dark. In daytime, HLC does not operate when it is too dark.
- When setting up HLC, there are minimum and maximum sizes to prevent malfunction of HLC.

#### WDR

The WDR (Wide Dynamic Range) mode shows both a dark area and a bright area clearly in a backlight environment. This method captures once with a fast shutter to show a bright area clearly and again with a slow shutter to show a dark area clearly, using the dual shutters of the camera, and then combines only the parts shown clearly from the two images into one image. If the WDR mode is used, noise may occur between the bright area and the dark area.



WDR mode off

WDR mode on

#### WDR level

Adjusts the intensity of backlight correction.

#### WDR control

Sets the WDR action option.

- Always use: the WDR mode is enabled at all times.
- Auto: Video is analyzed and WDR mode is automatically turned on when backlight correction is necessary.
- Turn off in low light: The WDR mode is automatically turned off in a low-light environment.

- Turn off in B/W: The WDR mode is automatically turned off when the B/W mode operates.

### **i** Note

- When WDR mode is selected, the shutter value will be reset. The screen will become bright and then become dark.
- When WDR mode is used, the frame rate is reduced by half.
- It is recommended to use the WDR mode when a camera is installed indoor and there is very strong backlight.
- If the WDR mode is used, noise may occur between the bright area and the dark area.
- If the WDR mode is used, noise may occur in the motion detection area.
- Please turn off the WDR mode because, depending on the lighting condition in WDR mode, the following problems could occur:
  - When there are unnatural color changes and/or unnatural symptoms on the screen.
  - When there is noise on the bright part of the screen.
- The WDR performance may vary depending on the size of bright areas on the screen, so adjust the installation angle properly for the best WDR performance.
- If you set the WDR level too high, the screen may exhibit unnatural symptoms.
- For the best WDR performance, it is recommended to set the exposure iris to [Auto].

## **Exposure**

Change the exposure according to the environment of the camera. If the background is darker than the subject, the subject will be shown normally only when the exposure is decreased. Conversely, if the background is brighter than the subject, the subject will be shown normally only when the exposure is increased.

## **Brightness**

The brightness of the screen can be adjusted. The higher the number, the brighter the screen.

## **Minimum shutter**

The shutter can set the sensor exposure automatically according to the environment; the electronic shutter operates at a range of between minimum shutter and maximum shutter. Minimum shutter means the minimum value of the possible range for exposure time and sets a long exposure time.

If the selected minimum shutter value is smaller than the fps value of [Sensor] mode, the frame rate can be reduced in the dark.

## **Maximum shutter**

Maximum shutter means the maximum value of the possible range for exposure time and sets a short exposure time.

## **Prefer shutter**

Set the proper exposure time that has a high priority in operation within the range of exposure time.

## **Anti flicker**

Prevents screen flickering that occurs due to inconsistency in the lighting in the capturing environment.

## SSNR

Remove noise from the image.

- On/Off: Sets whether or not to use the SSNR function. When [On] is selected, the SSNR level can be adjusted.
- Wise NR: When a moving object is in the image, the noise reduction level is adjusted automatically to improve object discrimination.

## SSNR level

Set the SSNR level. The level can be set when [On] is selected for [SSNR]. The higher the level, the less the noises, but then the video might become fuzzy.

## SSNR 2D Level

SSNR 2D reduces noise on the image using adjacent pixels in one frame. Set the SSNR 2D level. The level can be set when [On] or [Wise NR] is selected for [SSNR].

The higher the level, the less the noises, but then the video might become fuzzy.

## SSNR 3D Level

SSNR 3D reduces noise on the image using the pixels of various frames. Set the SSNR 3D level. The level can be set when [On] or [Wise NR] is selected for [SSNR].

The higher the level, the less the noises, but then the video might lag.

## Iris

Select the iris type

- DC (Auto): Automatically adjusts the iris depending on the optical intensity of the surroundings.
- Manual: Manually adjusts the iris's F number.
- P-Iris: Adjusts the iris through the step motor. A large depth of field can be secured so that a number of objects at various distances can be brought into focus at the same time.

## Iris F-No

Activated when [Iris] mode is set to [Manual], and it sets the iris f-number.

## AGC

AGC (Auto Gain Control) adjusts the brightness by controlling the sensitivity of image gain when capturing an object in dim light.

- Off: Disables the AGC function that brightens dark image by amplifying gain from video signal. When this option is selected, [SSNR] and [Day/Night] do not work.
- Manual:: Manually adjusts the AGC value.
- Max gain: Sets the max gain that can be auto-controlled depending on the brightness of the surrounding.

### Level (manual)

Sets the AGC level value manually as desired. The higher the level value, the higher the gain value, which results in a brighter screen even in a dark environment. If [Manual] is selected under [AGC], [Level (manual)] is enabled.

### Level (max gain)

Sets the max gain value. : Controls the max gain that is set based on the brightness of the surrounding. The higher the level value, the higher the max gain. If [Max gain] is selected under [AGC], [Level (max gain)] is enabled.

#### **i** Note

- The screen exposure can be saturated depending on the max/min range of shutter settings.
- It may take a while until the effect is applied or canceled after setting the Wise NR mode (SSNR 2D and SSNR 3D).
- The level of noise might go up despite the improved video detection ability after setting the Wise NR mode (SSNR 2D and SSNR 3D).
- In the bright environment with less noises, the effect of Wise NR (SSNR 2D and SSNR 3D) can be little.
- Since the motion detection function is used internally when the Wise NR (SSNR 2D and SSNR 3D) is enabled to detect motion in video, it is detected according to the operational condition of motion detection event. For the detailed motion detection settings, go to [Analysis] > [Motion Detection].
- As the usage of AGC increases, the SSNR 3D value for SSNR also increases, which could lead to stuttering in the video.
- AGC action increases screen noise.
- If AGC mode option is set to [Off] or [Manual], or if [Max gain] value is set to below 30 db, [Day/Night] cannot be set to [Auto].

### Day/Night

Change the image to color or b/w according to the camera's environment. When the dwell time is set, the image can be changed to color or b/w according to preference. When switching to Day/Night, a motion detection event or image analysis event cannot be detected.

### Mode

Selects the mode which changes the camera to color or b/w.

- Color: Outputs an image in color.
- B/W: Outputs an image in b/w.
- Auto: Switch to color mode during the daytime and b/w at night or in low light. However, if [AGC] under [Exposure] is set to [Off] or [Manual], or if [Max gain] is set below "below 30 dB", [Day/Night] cannot be set to [Auto].
- External: When an alarm input terminal is linked with external equipment, color and b/w can be controlled.
- Schedule: Day/Night is changed to the schedule set from [Activation time (Color)].

#### **i** Note

- [External]Options can be set when there is more than one alarm inputs. Select [Event]> [Alarm I/O] to set the alarm I/O.

### Dwell time

Changes to color or b/w when [Auto] is selected for Day/Night and the brightness condition is maintained for the set dwell time.

### Duration

Sets the time interval when switching to color or b/w occurs. Selecting [Customize] allows you to manually set the duration.

### Alarm input

Set the image to color or b/w according to the opening and closing status of the alarm sensor.

### Activation time (Color)

Sets the schedule for operation in color mode. When [Everyday] is selected and the time is set, color mode is activated at the relevant time every day, and b/w mode is activated at all other times. If you wish to not have color mode set for the same time every day, you can deselect [Everyday] and set the activation time to Mon., Tue., Wed., Thu., Fri., Sat. or Sun., respectively.

#### **i** Note

- When switching between night and day modes, the motion detection event will not take place. In other words, even if you 'Enable' the motion detection event, it will not detect when switching between night and day modes occurs. You can enable or disable the motion detection event in [Analytics] > [Motion Detection].

### Special

You can adjust an image for sharpness, contrast, and color level.

### DIS

When the camera is shaking due to external impacts, such as wind, DIS (Digital Image Stabilization) corrects the video automatically and stabilizes the screen.

#### **i** Note

- If you change the DIS setting, the video screen may be reduced or enlarged. Change the analytics and statistics settings so that you can analyze the video or accumulate the statistical data according to the changed video. These settings can be changed in the [Analytics] menu and [Statistics] menu.

### Sharpness

Adjust the overall sharpness of the image.

### **Sharpness level**

Adjust the overall sharpness of the image. You can set the sharpness level by setting [On] for [Sharpness].

The higher the sharpness level is, the stronger and clearer the video sharpness is.

### **Gamma control**

When set to [On], the brightness distribution of video is analyzed and its brightness level is adjusted.

### **Gamma**

Adjust the contrast of the image. This means the gap between the brightest part and the darkest part in an image; a higher gamma value means a clearer display of the difference in brightness.

### **Contrast**

Adjust the shade contrast of the image.

### **Local contrast**

Local contrast more clearly shows the subtle difference in brightness of video.

### **Local contrastLevel**

This is enabled by setting [Local contrast] to [Enable]. The higher the level value, the higher the contrast of video, which means a clearer image. However, this also increase the level of noise on the screen, and a warped form of the duplicated image might be more visible around the edges.

### **Color level**

Adjust the intensity of color in the image.

### **Defog**

Correct the image when it is foggy or cloudy. When [Auto] is set, the surrounding environment is detected and the image is corrected automatically. When [Manual] is set, the user can see the surrounding environment and set the correction level directly.

The default value is set to [Off].

### **Defog level**

Activated when [Manual] is set for [Defog]; it adjusts the defog level. A higher defog level displays the image more clearly. If the fog level is low and a high defog level is set, the screen may look darker.

### **i** Note

- If you set the Defog mode to [Auto], as the amount of fog decreases, the level of defog function is also lowered. If you want to maintain the same effect of the function despite a decrease in the fog, then set the Defog mode to [Manual].
- If the fog level is low and a manual high defog level is high, the screen may look darker.

## LDC

LDC (Lens Distortion Correction) corrects image distortion at the edge of a wide angle lens.

- Off: LDC (image distortion correction) function is not used.
- Manual: Adjusts the distortion correction level manually.
- AutoAdjusts the image distortion automatically.
- Fill (Manual): Corrects the video using the Fill mode. The correction values can be manually adjusted in [LDC level].
- Fill (Auto): Corrects the video using the Fill mode. The correction values are automatically set. Since Fill mode maintains the screen's top and bottom angular fields of view, the left and right end of the video could be cropped.
- Stretch (Manual): Corrects the video using the Stretch mode. The correction values can be manually adjusted in [LDC level].
- Stretch (Auto): Corrects the video using the Stretch mode. The correction values are automatically set. Since Stretch mode maintains the screen's top/bottom/left/right angular fields of view, none of the areas in the original video recording is lost, but the aspect ratio of the video is not maintained.

## LDC Level

Adjusts the distortion correction level. It is enabled by setting [LDC] to [Manual], or setting [Manual] to [Manual]. The higher the level value, the flatter the curved corners. The lower the level value, the less the changes to the curved corners.

## OSD

Display the camera title or the date and time, and set the location, size, color and transparency of the characters.

### Camera title

Sets whether or not to display the camera title. When [Enable] is selected, the [Add]/[Delete] buttons will be activated.

When you click the [Add] button, a field where a camera title can be entered will be added to the list. Enter the title of your camera, and move the cursor to set its location. Up to 5 camera titles can be added.

To delete a camera title, select the title to delete and click the [Delete] button. To preview how the camera title is displayed on the screen after entering it, enter the camera title and click the [Preview] button.

In the [Position] column, click the [Move] button. Then, OSD position is displayed as a triangular shaped icon on the preview video screen. You can move the icon to adjust the position of the OSD.

### Date & Time

To display the date and time on the screen, select [Enable]. Select the date display type and set the position to display the date and time by moving the cursor.

### Size

Adjust the size of OSD.

### Color

Set the color of OSD.

### Transparency

Set the transparency of OSD.

### Overlay image

The image you want can be displayed at the top left of the screen. [Upload image] menu allows you to upload images.

### Upload image

[...]button can be clicked to search files in bitmap format. Click the [Upload] button to upload image files. To delete image files applied to the screen, click the [Delete] button. The allowed image spec is 16-bit (RGB565 not supported) or 24-bit bitmap file. Its size should be a fixed 128x128 pixels, and the file size should be 52 KB or less.

#### **i** Note

- In case of the item with a location that can be adjusted(camera title, date & time), if it overlaps with other fixed OSD items, the screen may fail to display it properly.

### IR

### Mode

In the B/W mode when the IR LED is turned on, the saturation at the center of screen is prevented, so it is possible to identify a nearby object.

- Off: Disables the IR mode.
- Auto: Automatically adjusts the IR brightness depending on the brightness of object at the center of screen.
- Auto 1: Automatically adjusts the IR brightness depending on the brightness of object at the center of screen.
- Auto 2: Automatically adjusts the IR brightness depending on the brightness of object at and around the center of screen.
- Manual: Manually adjusts the IR brightness.

### Level

Set the IR level.

The IR level is enabled when [Manual] is selected in [Mode].

### Activation time

The camera always operates at a specific preset time. Set and use a desired image preset at the desired time.

### Off

The camera operates at the time selected in the image preset.

### Only scheduled time

You can set to allow a user to execute a desired image preset at a specific time. Select an image preset and set the start and end time. Set the image preset for each hour according to the usage of the camera.

The date from Sunday to Saturday, based on the current camera time, is displayed on the time table shown when [Only scheduled time] is selected. You can set the time by clicking or dragging on the time table with the mouse. The set activation time is executed repeatedly on the relevant weekday and time.

You can change the time view unit by clicking the [1 min], [30 min] or [1 h] button.

When you click the [Reset] button, all set event activation times will be deleted. To confirm or change the camera time, refer to [Basic]>[Date & Time].

## Smart codec

Smart codec is a technology that reduces the size of image data by setting an area desired by the user as an area of specific quality, while managing other areas at normal quality. When you complete the setting, click the [Apply] button at the bottom of the page.

### Manual ROI area

The user can set the area on the camera image screen. When you click and drag on the screen with the mouse, a square-shaped area will be created. 5 areas can be set, but overlapping is not allowed. When you click the [Clear] button, all set areas will be deleted.

#### **i** Note

- A smart codec can be set for each video profile. If you set [CBR] for [Bitrate control] in [Basic]>in [Basic]>[Video profile] and set [Disable] in [Smart codec] then the smart codec function will not operate in the profile.

### Smart codec setup

#### Quality

Select the quality level of an area set by the user. You can check an area in set quality level. The adjusted quality level of an area is always higher than normal quality.

EST.



1998

## Focus setup

The user can set the focus of the screen manually, or automatically through Simple Focus. The focus can also be reset to the default through [Initialize Focus].

### Focus setup

#### Initialize focus

To initialize focus, click the [Initialize focus] button. The focus will be adjusted to the default location.

When you use the camera for the first time, it is recommended to reset the focus.

#### Focus

Click the Focus button on the screen and adjust the focus manually. If auto focus control is not possible with simple focus, control the focus manually. The value displayed on the button refers to the focus moving interval. '1' means moving the focus by a factor of 1, while '10' means moving the focus by a factor of 10; '100' means moving the focus by a factor of 100. '-' moves the focus area nearer and '+' moves the focus area farther away.

#### Zoom

Manually adjusts the zoom magnification. The value displayed on the button refers to the zoom moving interval. '1' means moving the zoom by a factor of 1, '10' means moving the zoom by a factor of 10, and '100' means moving the zoom by a factor of 100. '-' means zoom out (wider) and '+' means zoom in (closer).

#### Simple Focus

The focus is adjusted automatically, based on the location designated by the user.

When you set the focus location by clicking and dragging on the screen with the mouse and then click the [Simple Focus] button, N (Near) and <->F (Far) are displayed on the screen and the focus is controlled automatically, based on the location designated by the user.

#### **i** Note

- The simple focus function may not operate properly;
  - if there is a sudden change (sudden movement, disappearance) in the subject
  - if there is a sudden change in luminance
  - if there is a sudden brightness change
  - if the image is low-contrast
  - if there is a strong light source in the vicinity
- In this case, if it is out of focus after simple focus operation, then use the Zoom button (-100, -10, -1, 1, 10, or 100) to manually adjust the focus.
- If it is hard to perform a simple focus operation in the environment, it is recommended to manually adjust the focus.

## WiseStream

WiseStream is a function that, by analyzing the complexity of an image, can effectively reduce the data size while still maintaining the quality. It reduces image size and saves on bandwidth by increasing the compression rate, if many motions are not created on the image being captured by the camera. If motion increases, the image returns to its previous status, preventing image information loss. This function is not suitable in an environment with much motion, as the screen may malfunction. When you complete the setting, click the [Apply] button at the bottom of the page.

### WiseStream

#### Mode

You can select how much the image will be compressed with WiseStream.

- Off: The WiseStream function is not used.
- Low~High: The WiseStream function allows you to set the level of reduction for the bitrate to be applied.

#### **i** Note

- To optimize the performance of the WiseStream, set [Dynamic GOV] and [Dynamic FPS] to [Enable] in the [Basic] > [Video Profile] menu. With [Dynamic GOV] and [Dynamic FPS] functions, you can achieve both the video quality and the number of frames per second.
- In any of the following cases, the WiseStream function may not operate properly:
  - If you switch the screen all of sudden, the screen display might not function properly.
  - In an environment with a lot of changes on the screen, use of the WiseStream function is not adequate.

EST.

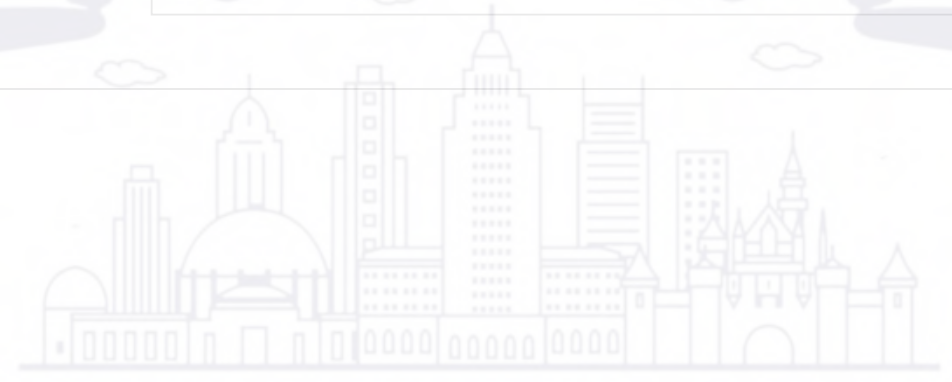

1998

WE SECURE YOUR LIFE



## DDNS

If you use DDNS (Dynamic Domain Name Service), you can set the IP address of the camera to be changed to a general host name which can be easily remembered by the user. If the IP address of the camera is 198.160.0.100, you can connect to the camera by entering a host name such as <http://ddns.hanwha-security.com/camera1> instead of the IP address. It is convenient since the user can connect to the camera with the DDNS address even if the IP address of the camera is changed.

The exclusive Wisenet DDNS for Hanwha Techwin or public DDNS can be used for DDNS. Enter the desired DDNS information and click the [Apply] button at the bottom of the page. If the connection to the selected DDNS is made, 'Successful' message will be displayed, and if the connection is not made, 'Failed' message will be displayed.

### **i** Note

To use the DDNS service, the setup of port forwarding for the DDNS and the router need to be done together. For the port forwarding setup method for the router, see the instruction manual shipped together with the product. When UPnP discovery function is enabled, DDNS cannot be used. UPnP discovery will be activated when the [UPnP discovery] option is set to [Enable] on [Network]>[Auto IP configure].

## DDNS

Off

Select if you wish not to use DDNS.

### Wisenet DDNS

Select when you use DDNS server provided by Hanwha Techwin. To use Wisenet DDNS, sign up for the membership at the Wisenet DDNS homepage (<http://ddns.hanwha-security.com> (<http://ddns.hanwha-security.com>)) and register the product at [My DDNS]>[Register Product].

- Server: Enter DDNS server name which you intend to use.
- Product ID: Enter ID of the product registered on Wisenet DDNS server. If [Quick connect] is selected when a router which supports the UPnP (Universal plug and play) function is used, it supports automatic opening of the port in case of connection from the outside.

### **i** Note

- If the router does not support the UPnP function or to use DDNS server without using [Quick connect], set manual for the port forwarding of the router. For the port forwarding setup method for the router, refer to the instruction manual included in the product.

### Public DDNS

Select it when you use DDNS server provided by a public website. Use it after signing up for the service at the relevant website.

- Server: Select public DDNS server which you intend to use.
- Host name: Enter a host name registered on DDNS server.
- User name: Enter the user name for DDNS server.
- Password: Enter the password for DDNS server.

## IP filtering

You can prepare an IP address list to allow or reject the connection for a specific IP. IP addresses are managed separately between IPv4 and IPv6. When you complete the setting, click the [Apply] button at the bottom of the page.

### Filtering type

[Deny registered IP] and [Allow registered IP] filtering conditions apply to all registered IP addresses.

- Deny registered IP: Denies access for a registered IP.
- Allow registered IP: Allows access for a registered IP

#### **i** Note

- When an access-authorized IP is registered, the IP currently connected to the camera should also be registered. Especially, when [Enable] is selected for [Basic]>[IP & Port]>[IPv6 setup], all IPv4 and IPv6 addresses of the IP addresses currently connected should be added.
- A currently-connected IP address cannot be registered as [Deny registered IP].

### IPv4

This is the address list for IPv4 types; an IP address can be added or deleted. Up to 10 IP addresses can be entered.

#### Adding an IPv4 address

1. Click the [Add] button. A field where an IPv4 address can be entered will be created.
2. Enter the IP and Prefix information. The filtering range for the entered information will be displayed.
3. Filtering for the relevant range is possible only after the [Use] box is checked.
4. Clicking the [Apply] button at the bottom of the page will save all information added to the list.

#### Deleting an IPv4 address

1. Select an IPv4 address you wish to delete.
2. Click the [Delete] button.
3. Click the [OK] button on the delete confirm window. The IPv4 address will be deleted.

#### **i** Note

- Addresses from 224.0.0.0 to 239.255.255.254, which are used for multicast, are not available.

### IPv6

This is the address list for IPv6 types; an IP address can be added or deleted. Up to 10 IP addresses can be entered.

#### **Adding an IPv6 address**

1. Click the [Add] button. A field where an IPv6 address can be entered will be created.
2. Enter the IP and Prefix information. The filtering range for the entered information will be displayed.
3. Filtering for the relevant range is possible only after the [Use] box is checked.
4. Clicking the [Apply] button at the bottom of the page will save all information added to the list.

#### **Deleting an IPv6 address**

1. Select an IPv6 address you wish to delete.
2. Click the [Delete] button.
3. Click the [OK] button on the delete confirm window. The IPv6 address will be deleted.



**EST.**

**1998**



**WE SECURE YOUR LIFE**



## HTTPS

You can select a secure connection system or install a public certificate. When you complete the setting, click the [Apply] button at the bottom of the page.

**Secure connection system** Select an appropriate secure connection system in consideration of the security level. HTTPS (Hypertext Transfer Protocol over Secure Socket Layer) sends and receives data through the process of encoding/decoding users' page requests over SSL sub layer under hypertext transport agreement layer. Therefore, this mode is safer than HTTP mode in terms of security. In the secure HTTPS mode, you can select to use either Proprietary certificate or Public certificate.

### HTTP (Do not use a secure connection)

Select when sending data without encryption

### HTTPS (Secure connection mode using a unique certificate)

Establishes a secure connection by using a unique certificate provided by the camera. When you select [HTTPS (Secure connection mode using a unique certificate)] and click the [Apply] button at the bottom of the page, a secure connection will be made in HTTPS mode.

### Change host name

Selecting [Change host name] option changes the camera's host name to the common name in the certificate. Some security check tools may see that the product's security is vulnerable if the camera's host name is different from the common name set in the certificate.

You can view the host name under [Basic]>[IP & Port]>[IP address]>[IPv4 setup]>[Host name].

### Mutual authentication

To proceed with mutual authentication for enhanced security, select[Mutual authentication].

As you proceed with mutual authentication, you can choose an option for allowing access.If [Allow all connections]is selected, all access attempts that tried mutual authentication are allowed for connection regardless of the success/failure of mutual authentication. This means that even without mutual authentication, camera access is granted. If [Allow only mutually authenticated connections] is selected, camera access is granted upon the success of mutual authentication only.

### HTTPS (Secure connection mode using the public certificate)

Establishes a secure connection using the public certificate. You can select this after installing the public certificate. When you select [HTTPS (Secure connection mode using the public certificate)] and click the [Apply] button at the bottom of the page, a secure connection will be made in HTTPS mode.

## TLS settings

Sets Cipher mode or TLS version to use for encrypted communication.

### Cipher mode

Provides cipher suites by combining various algorithms to use for TLS-encrypted communications, such as key exchange, authentication, and encryption. To use only cipher suites with a high level of security, select [Secure cipher suites only]. To use cipher suites with backward compatibility although less secure, select [All compatible cipher suites]. [All compatible cipher suites] includes both secure and not secure cipher suites.

### Version

Selects the TLS protocol version to use for encrypted communication.

If [Secure cipher suites only] is selected for [Cipher mode], you can select only TLS 1.2 or TLS 1.3. If [All compatible cipher suites] is selected, you can select any option you want out of all TLS versions.

## Install a public certificate

To select [HTTPS (Public Certificate in use)] in [Secure connection system], you need to install a public certificate first.

- Name for the certificate: Enter the name of the certificate to install.
- Certificate file: Select the path to the certificate to install.
- Key file: Select the path to the key file to install.

### **i** Note

- You cannot install or delete a public certificate when [HTTPS (Public Certificate in use)] mode is in effect. After changing to [HTTP (Secure Access not in use)] or [HTTPS (Private Certificate in use)] mode, be sure to install or delete the certificate.

### Installing a public certificate

1. Enter the name of the certificate to install in [Name for the certificate].
2. Click the [...] button in [Certificate file], select a certificate file in the Open window, and then click the [Open] button.
3. Click the [...] button in Key file, select a key file from the open window and click the [Open] button.
4. Click the [Install] button. Installation of the certificate is complete.

### Deleting a public certificate

Click the [Delete] button under [Install a public certificate].

## 802.1x

You can select whether or not to use the 802.1x protocol when connecting to a network, and install the certificates. When you complete the setting, click the [Apply] button at the bottom of the page.

### IEEE 802.1x Setup

#### IEEE 802.1x

To use IEEE 802.1x protocol for connecting to the network, select [Enable]. IEEE 802.1x is a part of the network protocol group called IEEE 802.1 and is the IEEE standard regarding port-based Network Access Control (PNAC). IEEE 802.1x is mainly used for reinforcing security in a wireless LAN (Wi-Fi) environment.

#### EAP Type

EAP (Extensible Authentication Protocol) is an authentication mode regulated in wireless networks and Point-to-Point protocols, and is designed for easy extension. The LEAP mode is a security-vulnerable authentication mode, so is recommended only for environments where EAP-TLS cannot be used.

- EAP-TLS: EAP-TLS (Transport Layer Security) carries out mutual authentication that requires a client certificate with the server; a dynamic WEP key is used for security after connection is made.
- LEAP: LEAP (Lightweight Extensible Authentication Protocol) does not require certificates and uses only a dynamic WEP key, so a strong password should be used.

#### EAPOL version

Select [1] or [2] for the version of the [EAPOL] (EAP over LANs) used in the network switch.

#### ID

Enter the client certificate ID for [EAP-TLS] and the user ID for [LEAP].

#### Password

Enter the client private key for [EAP-TLS] and the user password for [LEAP]. This is not necessary if an unencrypted key is used in [EAP-TLS].

#### **i** Note

- If the connected network equipment does not support 802.1x, it may not operate properly even if [Use] is set for 802.1x.

## Certificates

Certificates are necessary only when [EAP-TLS] is used. You can install or delete the relevant certificates and keys.

- CA certificates: Select if CA certificates include an open key.
- Client certificate: Select if CA certificates include a client authentication key.
- Client private key: Select if CA certificates include a client private key.

### Installing a Certificate

1. Click the [...] button, select a certificate or key and then click the [Open] button.
2. Click the [Install] button. When certificate installation is complete, a message saying 'Installed' is displayed.

### Deleting a Certificate

Click the [Delete] button beside the installed certificate or key. When a certificate or key is deleted, a message saying 'Not available' is displayed.



## QoS

QoS (Quality of Service) is the function that sets the priority of data transmission and secures the data transmission quality according to set priorities when overload (simultaneous traffic increase, network failure, etc.) occurs on the network. A QoS IP address can be entered in IPv4 or IPv6. When you finish the setting, click the [Apply] button at the bottom of the page.

### IPv4

A QoS IP address can be added or deleted in IPv4. The default values are 32 for Prefix and 63 for DSCP.

- Prefix: This value can set the IP range, and a value from 1 to 32 can be set in IPv4.
- DSCP: The QoS priority is DSCP (Differentiated Services Code Point). A value of 0 to 63 can be set for the DSCP value; as the value gets closer to 0, the priority becomes lower.

#### **i** Note

- Addresses from 224.0.0.0 to 239.255.255.254, which are used for multicast, are not available.

#### Adding an IPv4 address

1. Click the [Add] button. A field where an IPv4 address can be entered will be created.
2. Enter the IP, Prefix and DSCP information.
3. QoS can be applied to the relevant IPv4 address only after the [Use] check box is selected.
4. Clicking the [Apply] button at the bottom of the page will save all information added to the list.

#### Deleting an IPv4 address

1. Select an IPv4 address you wish to delete.
2. Click the [Delete] button.
3. Click the [OK] button on the delete confirm window. The IPv4 address will be deleted.

### IPv6

A QoS IP address can be added or deleted in IPv6. The default values are 128 for Prefix and 63 for DSCP.

- Prefix: This value can set the IP range; a value from 1 to 128 can be set in IPv6.
- DSCP: The priority for QoS is DSCP (Differentiated Services Code Point). A value of 0 to 63 can be set for the DSCP value; as the value gets closer to 0, the priority becomes lower.

#### Adding an IPv6 address

1. Click the [Add] button. A field where an IPv6 address can be entered will be created.
2. Enter the IP, Prefix and DSCP information.
3. QoS can be applied to the relevant IPv6 address only after the [Use] check box is selected.

4. Clicking the [Apply] button at the bottom of the page will save all information added to the list.

### Deleting an IPv6 address

1. Select an IPv6 address you wish to delete.
2. Click the [Delete] button.
3. Click the [OK] button on the delete confirm window. The IPv6 address will be deleted.



## SNMP

SNMP (Simple Network Management Protocol) is a network management protocol which can collect information from the equipment on the network, and manage the network. When you finish the setting, click the [Apply] button at the bottom of the page.

### SNMP v1/v2c

SNMP v1 protocol is not encrypted and has almost no security function. It also tends to use excessive bandwidth, so if there is much equipment, it may be difficult to manage the network. An algorithm has been added to SNMP v2c protocol for data and authentication security, allowing for more efficient bandwidth than with SNMP v1.

#### SNMP v1

To use SNMP v1, select [Enable].

#### SNMP v2c

To use SNMP v2c, select [Enable]. When [SNMP v2c] is selected, the Read community and Write community will be enabled.

#### Read community

Enter the read-only community name to access SNMP information. The default value is public.

#### Write community

Enter the write-only community name to access SNMP information. The default value is write.

### SNMP v3

SNMP v3 authentication has stronger security than v1 and v2c; transmission without data transformation is possible. The packet is also encrypted to block unauthorized users from accessing data.

#### SNMP v3

To use SNMP v3, select [Enable].

#### Password

Set the user password for SNMP v3. Passwords must be between 8 and 16 characters. The default password is weak, so changing it to a new password is highly recommended immediately after installing the product. Users are responsible for security and other issues due to continued use of the default password.

**i Note**

- To use SNMP v3, the 'Secure connection system' needs to be set to '[HTTPS]' mode. Go to [Network] > [HTTPS] (ssl.html) > [Secure connection system] and then select [HTTPS (Secure connection mode using a unique certificate)] or [HTTPS (Secure connection mode using the public certificate)].
- Failure to use SNMP v3 may result in security issues.

## SNMP traps

The SNMP Trap is a function that delivers specific events in the equipment on the network to the management system.

### SNMP traps

To use SNMP Trap, select [Enable].

### Community

Enter the name of the trap community that receives the message.

### IP address

Enter the IP address of the user sending the message.

- Authentication failure notification: Set whether or not to deliver an event to the management system when community information is incorrect.
- Network connection notification: Set whether or not to deliver an event to the management system when the disconnected network is reconnected.

EST.

1998

WE SECURE YOUR LIFE



## Auto IP configure

You can set the camera IP automatically. You can assign an IP address that can connect to an additional camera on the same local network or set the camera IP to check for a camera connected to the network on Windows or Mac OS. When you finish the setting, click the [Apply] button at the bottom of the page.

---

**Link-Local IPv4 address** You can assign an additional IP that can connect to a camera from the same local network.

### Auto configure

To use auto configuration of a Link-local IPv4 address, select [Enable].

- IP address: The assigned IP address is displayed.
- Subnet mask: The subnet mask of the assigned IP address is displayed.

---

**UPnP discovery** You can search for a camera automatically from clients and OS that support the UPnP (Universal Plug and Play) protocol.

### UPnP discovery

To use UPnP discovery, select [Enable].

- Friendly name: The camera name is displayed. The friendly name is displayed in order of WISENET - model name - MAC address.

---

## Bonjour

You can search for a camera automatically from clients and OS that support the Bonjour protocol. Connected cameras are displayed on the Bonjour bookmark of the Safari web browser on Mac OS, which supports Bonjour by default.

### Bonjour

To use Bonjour, select [Enable].

- Friendly name: The camera name is displayed. The friendly name is displayed in order of WISENET - model name - MAC address.

#### **i** Note

- If the bookmark is not displayed, check Bookmarks in the 'Preferences' menu.

## Event setup

You can manage events and event action settings supported by the camera in one location. When you change event action settings on the current page, the event action settings on the detailed configuration page for each event will also be changed. When you complete the setting, click the [Apply] button at the bottom of the page.

### Event list

- Use: When check boxes in the [Use] column are selected, only the selected event(s) will operate.
- Type: Selecting an event name in the [Type] column will take you to the detailed setup page for the relevant event.
- Event action settings: Determines which event action settings will be carried out by the camera when an event is created.
  - FTP: To capture and send an image screen to an FTP server, select the check box in the [FTP] column. Detailed settings for FTP can be done from [Event]>[FTP/E-mail].
  - E-mail: To capture and send an image screen by e-mail, select the check box in the [E-mail] column. Detailed settings for e-mail can be done from [Event]>[FTP/E-mail].
  - Record: To record an image, select the check box in the [Record] column. Detailed settings for storage can be done from [Event]>[Storage].
  - Alarm output: Select [Off] if you wish no alarm when an event is created; select the appropriate time if you wish to output an alarm. You can set a continuous alarm until turned off by the user by selecting [Always] or set the alarm for 5, 10 or 15 seconds. Detailed settings for alarm output can be done from [Event]>[Alarm I/O].
  - Audio clip: Select an audio clip to play when an event occurs. You can set a different audio clip for each event type. Go to [Video & Audio]>[Audio setup]>[Audio clip] to register an audio clip.

#### **i** Note

- Depending on the alarm output setup, [Alarm output] columns may look different. If there is no alarm output, [Alarm output] columns are not displayed. If there is more than one alarm output, the columns are displayed as [Alarm output 1], [Alarm output 2], and so on. Select [Event]>[Alarm I/O] to set the alarm I/O.

## Handover

Handover is a function that the receiver camera moves to the PTZ preset position when an event occurs. On this page, you can set the camera and preset position to move to the preset position. When you complete the setting, click the [Apply] button at the bottom of the page.

### Receiver camera

You can add or delete PTZ cameras for receiving. Up to 32 receiver cameras can be registered.

Information of cameras registered as the receiver camera is displayed.

#### How to add a receiver camera

1. Click the [Add] button.
2. In the [Add Camera] window, enter the PTZ camera information to receive the handover.
  - No.: Set the receiver camera number. In the [Analytics] submenu, the receiver camera number is used when setting the handover receiver camera.
  - IP type: Set the IP address type between IPv4 and IPv6.
  - HTTP/HTTPS: Select which communication type to use between HTTP and HTTPS.
  - IP address: Enter the IP address of the receiver camera.
  - Port: Enter the port number of the receiver camera.
  - User: Enter the access ID to access the receiver camera.
  - Password: Enter the password to access the receiver camera.
  - Preset no.: Enter the preset position number to which the receiver camera will move. The preset number should be set in advance in the PTZ camera for reception. In the handover menu, enter the preset PTZ number.
3. Click [Apply].

#### How to delete a receiver camera

1. Click a check box in the list of receiver cameras, and select the camera you want to delete.
2. Click the [Delete] button, and when the confirmation window appears, click [OK].

EST.

1998

WE SECURE YOUR LIFE



## FTP / E-mail

When an event is created while the camera is capturing an image, the captured image can be sent to an FTP server or by e-mail. Enter the appropriate FTP server and e-mail configuration information to be used.

When you enter FTP server or e-mail server information and click the [Apply] button at the bottom of the page, an FTP server connection test or an e-mail test will be carried out. If an incorrect FTP server address or e-mail server address is entered, a message saying 'Failed' will be displayed. If the test is successfully done, the message saying 'Successful' will be displayed

---

### FTP configuration

#### Server address

Enter the IP address for the FTP server where an event creation image will be sent.

#### ID

Enter the ID for the FTP server login account.

#### Password

Enter the password for the FTP server login account.

#### Upload directory

Enter the directory of the FTP server where an event creation image will be recorded.

#### Port

Enter the port value of the FTP server. The default port value of the FTP server is 21, which can be changed according to the FTP server settings. The port can be changed within a range of 1 to 65535.

#### Passive mode

Select [Enable] when connection in passive mode is necessary due to firewall or FTP server configuration.

---

### E-mail configuration

#### Server address

Enter the e-mail SMTP server address for sending an event creation image by e-mail.

#### Authentication

Select whether or not to authenticate with an ID and password each time an e-mail is sent.

**TLS**

Set whether or not to use TLS. Select [Enable] if using an e-mail server that requires security.

**ID**

Enter the ID for the login account connected to the e-mail SMTP server.

**Password**

Enter the password for the login account connected to the e-mail SMTP server.

**Port**

Enter the port value of the e-mail SMTP server. The default port value of the e-mail server is 25; the port value when using TLS is 465.

**Recipient**

Enter the email address of the e-mail recipient.

**Sender**

Enter the email address of the e-mail sender. If the address of the sender is not correct, the intended recipient may not receive the e-mail.

**Subject**

Enter the subject of the e-mail to be sent when an event is created.

**Message**

Enter the body information for the e-mail to be sent when an event is created. When an event is created, the captured image will be sent as an e-mail attachment.

COLLSAM SECURITY

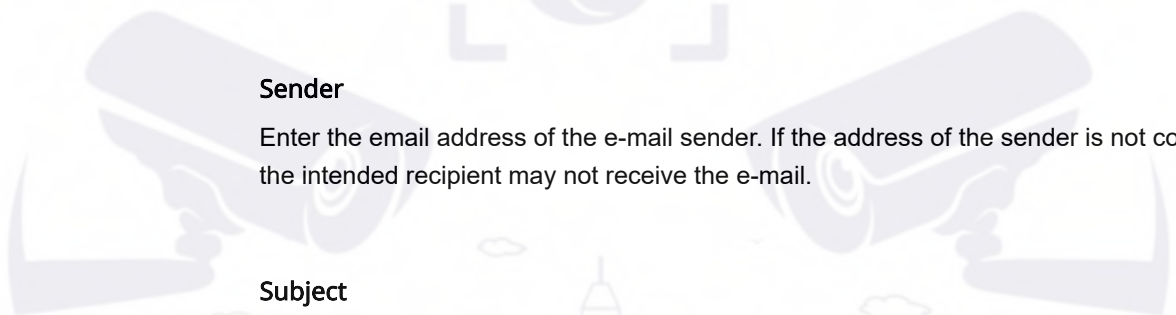

EST.

1998

WE SECURE YOUR LIFE



## Storage

You can select a device to capture a camera image and set the recording conditions. When you complete the setting, click the [Apply] button at the bottom of the page.

### Storage action setup

Selecting a recording device and selecting [On] allows you to change the setting for the relevant device.

If data is being recorded on the device, 'Recording' is displayed in [Status] in the device list. When 'Error' is displayed in [Status], check if the recording device is connected properly.

When [On] is set for an SD card and NAS at the same time, NAS is processed by priority.

- SD: You can set whether or not to use an SD card. When an SD card is recognized, the free space, total capacity and status are displayed. To format the SD card, click the [Format] button.
- NAS: You can set whether or not to use NAS (Network Attached Storage). When a connection to NAS is established, the free space, total capacity and status are displayed. To format the default folder on NAS, click the [Format] button.

### Overwrite

Sets whether or not to use the overwrite function of an SD card or NAS. When the device capacity has been reached, new data will be recorded over the oldest data.

When the device capacity has been reached, a message saying 'Full' is displayed in [Status] in the device list.

### Auto delete

Sets whether or not to use the auto delete function. The most recent data for the set number of days is kept and the rest will be deleted. The number of auto delete days can be set from 1 to 180. The [Auto delete] function is activated only when [Enable] is set for [Overwrite].

#### **i** Note

- When 'Error' is displayed in [Status] in the device list, check whether the recording device is connected properly, whether the file system of the recording device is damaged or not, and whether the recording device is physically damaged. If the 'Error' message persists after checking the recording device, format or replace the device.
- Recording may not be possible due to temporary network disconnection when NAS is used, so it is recommended to use an SD card also.
- When resolution, bit rate and frame rate are set at high, the amount of image data also increases. If the amount of data increases, a frame skip may occur even if set to full frame. If frame skipping occurs, then at least one image is saved per second.
- Before removing the (Micro) SD card, first switch to [Off]. If you remove it on your own or power up the camera with a unstable source of electricity without switching to [Off], it can damage the (Micro) SD card.
- If you use the (Micro) SD memory card below the recommended speed, it can cause frame skipping. If you use the (Micro) SD memory card with too large capacity, it can slow down the format speed.

- If you use NAS, auto deletion is supported only when the NAS capacity is above the recommended specifications.
- Deleted data cannot be restored.

## SD File System

This menu is displayed only when [SD card] is selected in the [Device] column of [Storage action setup], allowing you to select the file system on the SD card. SD cards support VFAT and EXT4 file systems, so select the file system according to the SD card of the camera you are using. If the file system of the SD card is EXT4, Windows OS can recognize it only when a separate application is installed.

### Type

Select either VFAT or EXT4 for the file system of the SD card. When the setting is changed, all existing data will be formatted. Be sure to back up data before changing the setting.

#### Note

- High Endurance SD Cards are recommended. For detailed information, refer to the Hanwha Techwin website.
- It can take up to 10 minutes to format the (Micro) SD card with the EXT4 file system.

## Encryption

SD card encryption allows you to save video data in your encrypted SD card (or microSD card). This keeps your SD card safe and secured even when you lost it. The SD card encryption option appears when you select [SD] for [Device] under the [Storage action setup] column.

#### Note

- If you change the SD card setting to encrypt or decrypt it, all of its data will be deleted and the SD card will be formatted.

### SD card encryption

Selecting [Enable] encrypts the SD card while deselecting [Enable] decrypts it.

#### Encrypting SD card

1. Select [Enable] under [Encryption].
2. Enter your [New password] in the field, and enter the same password again in the [Confirm new password].
3. Click the [Apply] button at the bottom of the screen.
4. If SD card encryption is working properly, the 'Encrypted' message will appear.

#### Decrypting SD card

1. Deselect [Enable] under [Encryption].
2. Click the [Apply] button at the bottom of the screen. If SD card encryption is disabled, so the SD card data is not encrypted, 'Unencrypted' message will appear.

## Changing password

You can change the password for SD card encryption.

If the password of the encrypted SD card and the password entered by user do not match, 'Password error' message will appear in the [Status] column of [Storage action setup].

1. Click the [Change password] button.
2. Enter the current password in the [Current password] field.
3. Enter the new password in the [New password] and [Confirm new password] fields.
4. Click the [Apply] button at the bottom of the screen.

### **i** Note

- Once forgotten or lost, your password cannot be recovered. You can reset your password instead, but then the SD card will be formatted and all of its data will be deleted.
- The password length and restrictions are as follows:
  - For password of 8 to 9 digits, you need to combine at least three different types of the following: uppercase and lowercase alphabets, numbers, and special characters.
  - For password of 10 to 15 digits, you need to combine at least two different types of the following: uppercase and lowercase alphabets, numbers, and special characters.
  - You cannot use four or more consecutive characters (e.g. 1234, abcd).
  - You cannot use the same character four or more times in a row (e.g. !!!!, 1111, aaaa).
  - Only ~!@#\$\$%^\*()\_-=+{|}[].?/ are allowed for special characters.

## NAS connection setup

This menu is displayed only when [NAS] is selected in the [Device] column of [Storage action setup] and the NAS access information is entered. Enter NAS information and click the [Test] button to see if the connection to NAS is established. If a connection is made, a 'Success' message is displayed. If a connection is not made, a 'Failure' message is displayed.

### IP address

Enter the NAS IP address.

### ID

Enter the ID for the account registered on NAS.

### Password

Enter the password for the account registered on NAS.

### Default folder

Designate the default folder where NAS will record image data.

### **i** Note

- If a failure message is displayed when you test after entering NAS information, check the following items:
  - Check if the IP address, ID, password, and default NAS folder are entered correctly.
  - Check if the IP address type of NAS and the IP address type of the camera are identical. (e.g.: The default value of NAS and the camera is 255.255.255.0. If the IP address is

192.168.20.32, the NAS IP address should be between 192.168.20.1 and 192.168.20.255.)

- For the NAS default folder, only one folder should be used in one camera, with no duplication.
- Check if the device is recommended NAS equipment. Refer to 'Recommended NAS specifications' in the user's manual.
- If [Overwrite] in the storage setup for NAS is not used and the free space for NAS is less than 20%, images will be recorded on the SD card.
- If an SD card which was used in another camera is inserted while data is being recorded on NAS, images may not be recorded.
- If the NAS setup is changed while data is being recorded on NAS, the change will not apply immediately.
- If NAS equipment is removed or the network connection is terminated while data is being recorded on NAS, the NAS recording action may be terminated.
- When resolution, bitrate and frame rate are set at high, the amount of image data also increases. If the amount of data increases, a frame skipping may occur even if set to full frame rate. If frame skipping occurs, then at least one image is saved per second.
- Check if you are trying to access as another user without formatting the default folder that is saved or used already.

## Record setup

### Edge recording profile

The name of the video profile which will be used for recording is displayed. The profile set as 'Edge recording profile' from [Basic]>[Video profile] > [Profile type] is displayed.

### Continuous recording

Sets for normal recording with no event; Video is saved with a fixed frame rate at all times in an ordinary situation without an event.

- None: No camera image is recorded.
- I-Frame: Records I-Frame only for continuous recording.
- Full frame: Records full frame for continuous recording.

### Event recording

Sets the recording type when an event occurs.

- I-Frame: Records only I-Frame when an event occurs.
- Full frame: Records full frame when an event occurs.

### Pre event duration

Sets the image recording time before an event occurs. An image can be recorded at 1 second, 3 seconds and 5 seconds prior to the occurrence of an event.

### Post event duration

Sets the image recording time span after an event. An image can be recorded for 5 seconds, 10 seconds, 30 seconds, 60 seconds or 120 seconds after the occurrence of an event.

### Record file type

Sets the file format for recording an image. When the file recording format is changed, the existing data will be erased.

- STW: This is the unique file type for Hanwha Techwin.
- AVI: This is an AVI file.

---

## Continuous recordingSchedule

You can set the time to record an image on the recording device.

### Always

Always records an image on the recording device.

### Only scheduled time

Records an image only at the scheduled time. The date from Sunday to Saturday, based on the current camera time, is displayed on the time table shown when [Only scheduled time] is selected. You can set the time for recording by clicking or dragging on the time table with the mouse. The set time is executed repeatedly on the relevant weekday and time.

You can change the time view unit by clicking the [1 min], [30 min] or [1 h] button. When you click the [Reset] button, all set event activation times will be deleted. To confirm or change the camera time, refer to [Basic]>[Date & Time].



EST.

1998

WE SECURE YOUR LIFE



## Alarm I/O

The I/O port of a camera can be set either as an input or output port as desired. After selecting it to be either an input or output port, you can set the details of each Alarm I/O. When you complete the setting, click the [Apply] button at the bottom of the page.

### **i** Note

If you use all alarm ports as output, the [External] mode of [Day/Night] will be disabled. If it is already set to [External], it will be changed to the [Auto] mode. You can select [Video & Audio]>[Camera setup]>[Day/Night] to check the External mode of Day/Night.

### Alarm I/O

After selecting a port number, decide whether to use the port as an input or output port. After selecting input or output, click the [Apply] button. If [Input] is selected, [Input device setup], [Event action settings], and [Event schedule] can be set. If [Output] is selected, [Alarm output] can be set. The number of supported alarm inputs/outputs may differ by camera.

### Input device setup

Sets whether or not to use an alarm input device and the type to activate an alarm event when an alarm input is given.

#### Input device setup

To use an alarm input device, select [Use].

#### Type

Select the alarm input type.

### Event action settings

Sets your camera's behavior when an alarm input event occurs.

#### FTP

To save an image on an FTP server when an alarm input event is created, select [Enable]. Detailed settings for FTP can be done from [Event]>[FTP/E-mail].

#### E-mail

To send an image by e-mail when an alarm input event is created, select [Enable]. Detailed settings for e-mail can be done from [Event]>[FTP/E-mail].

## Record

To save an image on an SD card or NAS when an alarm input event is created, select [Enable]. Detailed settings for storage can be done from [Event]>[Record].

## Alarm output

You can set the alarm output for a specific alarm number when an alarm input event is created. After selecting an alarm output number, select [Off] if you wish no alarm, or select the output time if you wish to output an alarm. You can set a continuous alarm until turned off by the user by selecting [Always] or set the alarm for 5, 10 or 15 seconds.

Depending on the number of output alarms supported by your camera, the display of Alarm output option will vary. For example, if there are 2 alarms for output, the option will display 'Alarm output 1' and 'Alarm output 2'.

## Goto preset

You can set the position of camera view to move to a preset number when an alarm input event is created. The camera preset can be set in [PTZ]>[Digital PTZ] or [Preset] of [External PTZ].

## Audio clip

This enables playback of a specific audio clip when an alarm input event occurs. Once you select a file from your audio clip list, the clip will start to play when the event occurs. To disable the audio clip from playing when an event occurs, select [Off]. Clicking the Play button (▶) allows you to play and preview an audio file. Go to [Video & Audio]>[Audio setup]>[Audio clip] to register an audio clip.

## Event activation time

This sets the event action settings from [Event action settings] to always operate, or only at the set time when an alarm input event is created.

### Always

The event action settings are always executed when an alarm input event is created.

### Only scheduled time

The event action settings are executed when an alarm input event is created during the set time. The date from Sunday to Saturday, based on the current camera time, is displayed on the time table shown when [Only scheduled time] is selected. You can set the time for event action settings by clicking or dragging on the time table with the mouse. The set event activation time is executed repeatedly on the relevant weekday and time.

You can change the time view unit by clicking the [1 min], [30 min] or [1 h] button. When you click the [Reset] button, all set event activation times will be deleted. To confirm or change the camera time, refer to [Basic]>[Date & Time].

## Alarm output

Sets how to control an alarm when an alarm is outputted by the user or when an event is created.

The setting on the alarm output event applies to [Alarm output] in [Event]>[Event setup] pages equally.

When changing the type of alarm output, the Alarm output button on the Live page and the type of alarm output in the Event setup are changed.

### Type

Selects the alarm output type.

- N.O. (Normal Open): The alarm output sensor is open by default and when it is closed, an alarm is outputted.
- N.C. (Normal Close): The alarm output sensor is closed by default and when it is open, an alarm is outputted.

### Mode

Sets the control type when an alarm is outputted.

- Pulse: An alarm is outputted for the time set in [Duration] and the alarm turns off automatically.
- Active/Inactive: When you press the alarm output button on the monitoring screen, an alarm will turn on; when you press the button again, the alarm will turn off.

### Duration

Sets the alarm output time when [Pulse] is selected in [Mode].

COLLSAW SECURITY

EST.

1998

WE SECURE YOUR LIFE



## Time schedule

The time schedule event can send an image file according to the event action settings in the transfer interval. When you complete the setting, click the [Apply] button at the bottom of the page. The setting on the time schedule event applies to [Time schedule] in [Event]>[Event setup] pages equally.

---

**Event setup schedule** To use the event schedule, select [Enable].

---

**Transfer interval** Sets the transfer interval of an image. This sets for how many seconds or minutes each image is created as an event. Click the drop-down menu and select a number and a unit.

**Note**

- Image can be transmitted only if the transfer interval is set lower than the operation interval in the event action settings.

---

**Event action settings** **FTP**  
To save an image on an FTP server when a time schedule event is created, select [Enable]. Detailed settings for FTP can be done from [Event]>[FTP/E-mail].

---

**Event activation time** This sets the event action settings in [Event action settings] to always operate, or only at the set time when a time schedule event is created.

**Always**

The event action settings are always executed when a time schedule event is created.

**Only scheduled time**

Periodically performs a specific operation at the predetermined time and day. The date from Sunday to Saturday, based on the current camera time, is displayed on the time table shown when [Only scheduled time] is selected. You can set the time for event action settings by clicking or dragging on the time table with the mouse. The set event activation time is executed repeatedly on the relevant weekday and time.

You can change the time view unit by clicking the [1 min], [30 min] or [1 h] button. When you click the [Reset] button, all set event activation times will be deleted. To confirm or change the camera time, refer to [Basic]>[Date & Time].

---



## Network disconnection

When network connection is terminated, an event can be created. When you complete the setting, click the [Apply] button at the bottom of the page. The setting on the network disconnection event applies to [Network disconnection] in [Event]>[Event setup] pages equally.

---

**Network disconnection** To use the network disconnection event, select [Enable].

---

### Event action settings

#### Record

To save an image on an SD card or NAS when a network disconnection event is created, select [Enable]. Detailed settings for storage can be done from [Event]>[Storage].

#### Alarm output

You can set the alarm output at a specific alarm number when a network disconnection event is created. After selecting an alarm output number, select [Off] if you wish no alarm, or select the output time if you wish to output the alarm. You can set a continuous alarm output, until the user stops the alarm, by selecting [Always] or set the alarm output for 5, 10 or 15 seconds.

Depending on the alarm output setup, [Alarm output] options may look different. If there is no alarm output, [Alarm output] options are not displayed. If there is more than one alarm output, they are displayed as [Alarm output 1], [Alarm output 2], and so on.

Select [Event]>[Alarm I/O] to set the alarm I/O.

#### Goto preset

You can set the position of camera view to move to a preset number when a network disconnection event is created. The camera preset can be set in [PTZ]>[Digital PTZ] or [Preset] of [External PTZ].

---

### Event activation time

Sets the event action settings in [Event action settings] to always operate, or only at the set time when a network disconnection event is created.

#### Always

The event action settings are always executed when a network disconnection event is created.

### Only scheduled time

The event action settings are executed only when a network disconnection event is created during the set time. The date from Sunday to Saturday, based on the current camera time, is displayed on the time table shown when [Only scheduled time] is selected. You can set the time for event action settings by clicking or dragging on the time table with the mouse. The set event activation time is executed repeatedly on the relevant weekday and time.

You can change the time view unit by clicking the [1 min], [30 min] or [1 h] button. When you click the [Reset] button, all set event activation times will be deleted. To confirm or change the camera time, refer to [Basic]>[Date & Time].

COLLSAM SECURITY



EST.

1998



WE SECURE YOUR LIFE



## App event

An event can be created according to the rules defined in the application installed from [\[Open platform\]](#). When you complete the setting, click the [\[Apply\]](#) button at the bottom of the page. The setting on the app event applies to [\[App event\]](#) in [\[Event\]>\[Event setup\]](#) pages equally.

---

**App event** To use the app event, select [\[Enable\]](#).

---

**Event action settings**

**FTP**

To save an image on an FTP server when an app event is created, select [\[Enable\]](#). Detailed settings for FTP can be done from [\[Event\]>\[FTP/E-mail\]](#).

**E-mail**

To send an image by e-mail when an app event is created, select [\[Enable\]](#). Detailed settings for e-mail can be done from [\[Event\]>\[FTP/E-mail\]](#).

---

**Event activation time** This sets the event action settings in [\[Event action settings\]](#) to always operate, or only at the set time when an app event is created.

**Always**

The event action settings are always executed when an app event is created.

**Only scheduled time**

The event action settings are executed when an app event is created during the set time. The date from Sunday to Saturday, based on the current camera time, is displayed on the time table shown when [\[Only scheduled time\]](#) is selected. You can set the time for event action settings by clicking or dragging on the time table with the mouse. The set event activation time is executed repeatedly on the relevant weekday and time.

You can change the time view unit by clicking the [\[1 min\]](#), [\[30 min\]](#) or [\[1 h\]](#) button. When you click the [\[Reset\]](#) button, all set event activation times will be deleted. To confirm or change the camera time, refer to [\[Basic\]>\[Date & Time\]](#).

---

## Shock detection

If a shock or vibration is detected on the camera or a change in physical position is detected, a shock detection event can be generated. When the setting is completed, click the [Apply] button at the bottom of the page. The settings for shock detection events are the same for [Shock detection] on the [Event]> [Event Setup](#) page.

---

### Shock detection

#### Enable shock detection

To enable shock detection events, select [Enable shock detection].

#### Level of detection

Set the level value that is the basis of shock detection. If a shock is detected above the set level value, a shock event is generated.

When a shock or vibration is detected, a graph showing the shock or vibration value applied to the camera is displayed, and when a shock detection event occurs, the graph color changes.

#### Sensitivity

The higher the sensitivity, the more sensitive the detection level graph will be.

---

### Event action settings

#### FTP

To save an image on an FTP server when a shock detection event is created, select [Enable]. Detailed settings for FTP can be done from [Event]>[FTP/E-mail](#).

#### E-mail

To send an image by e-mail when a shock detection event is created, select [Enable]. Detailed settings for e-mail can be done from [Event]>[FTP/E-mail](#).

#### Record

To save an image on an SD card or NAS when a shock detection event is created, select [Enable]. Detailed settings for storage can be done from [Event]>[Storage](#).

#### Alarm output

It is possible to set the alarm output number for a specific alarm when a shock detection event is created. After selecting an alarm output number, select [Off] if you wish no alarm, or select the output time if you wish to output an alarm. You can set a continuous alarm until turned off by the user by selecting [Always] or set the alarm for 5, 10 or 15 seconds.

Depending on the alarm output setup, [Alarm output] options may look different. If there is no alarm output, [Alarm output] options are not displayed. If there is more than one alarm output, they are displayed as [Alarm output 1], [Alarm output 2], and so on. Select [Event]>[Alarm I/O] to set the alarm I/O.

### Goto preset

You can set the position of camera view to move to a preset number when a tampering detection event is created. The camera preset can be set in [PTZ]>[Digital PTZ] or [Preset] of [External PTZ].

### Audio clip

This enables playback of a specific audio clip when a shock detection event occurs. Once you select a file from your audio clip list, the clip will start to play when the event occurs. To disable the audio clip from playing when an event occurs, select [Off]. Clicking the Play button (▶) allows you to play and preview an audio file. Go to [Video & Audio]>[Audio setup]>[Audio clip] to register an audio clip.

### Event activation time

This sets the event action from [Event action settings] to always operate, or only at the set time when a shock detection event is created.

#### Always

The event action settings are always executed when a shock detection event is created.

#### Only scheduled time

The event action settings are only executed when a shock detection event is created during the set time. The date from Sunday to Saturday, based on the current camera time, is displayed on the time table shown when [Only scheduled time] is selected. You can set the time for event action settings by clicking or dragging on the time table with the mouse. The set event activation time is executed repeatedly on the relevant weekday and time.

You can change the time view unit by clicking the [1 min], [30 min] or [1 h] button. When you click the [Reset] button, all set event activation times will be deleted. To confirm or change the camera time, refer to [Basic]>[Date & Time].

## Motion detection

A motion detection event can be created when a motion detection area and the exclude area are set and a motion is detected from inside the area set by the user. When you complete the setting, click the [Apply] button at the bottom of the page.

The setting on the motion detection event applies to [Motion detection] on the [Event]>[Event setup] pages equally.

### Motion detection

#### Enable motion detection

To use the motion detection event, select [Enable motion detection].

#### **i** Note

- The motion detection area and the exclude area are set and used according to the size range of the motion.
- In any of the following cases, the performance of the motion detection event may deteriorate and a malfunction may occur:
  - If an object is similar in brightness or color to the background on the screen
  - If a small motion occurs near the edge of the screen
  - If an overall change on the screen occurs continuously at random due to factors such as scene changes and sudden illumination changes
  - If a moving object comes too close to the camera
  - When one object hides another object
  - When the motion of an object is too fast
  - When reflection, blurring or shading occur due to strong light such as direct sunlight, high illumination or headlights from a vehicle
  - In cases of severe snow, rain or wind, or sunset or sunrise.

### Area

The area designated by the user is set as the motion detection area.

#### Setting an area

When you select 4 corners of an image with the mouse, it is set as the motion detection area and the color of the number buttons in [Area] changes.

Up to 8 areas can be set and the level, sensitivity, and minimum duration can be set separately for each motion detection area.

#### Changing an area

You can change the size of a motion detection area by moving a corner of the motion detection area. To move a motion detection area, click and drag the relevant area with the mouse.

#### Deleting an area

To delete a motion detection area, click the right mouse button at the relevant area on the screen and click the [OK] button on the delete confirm window.

### Area

When a motion detection area is added, the color of the number buttons in [Area] will change. When you click the number button, the relevant motion detection area will appear from the preview screen.

### Level of detection

This sets the standard level of motion detection. You can set the level for each motion detection area in [Area], and when a motion is larger than the set level, a motion detection event will be created.

Also, as a motion in each area is detected, a motion graph will appear, and when a motion event is created, the color of the graph will change.

### Sensitivity

This sets the motion detection sensitivity for each area. Set a lower sensitivity for an environment where the background and an object are clearly distinguishable and a higher sensitivity for an environment where the background and an object are not clearly distinguishable.

### Minimum duration (s)

Minimum duration (s): Sets the minimum amount of time to trigger an event after detection. When the movement lasts longer than the set period of time, the event is triggered.

### Exclude area

The area designated by the user is set as the exclude area.

#### Setting an exclude area

When you select 4 corners of an image with the mouse, it is set as the exclude area, and the color of the number buttons in [Area] changes. Up to 8 exclude areas can be set.

#### Changing an exclude area

You can change the size of an exclude area by moving a corner of the exclude area. To move an exclude area, click and drag the relevant area with the mouse.

#### Deleting an exclude area

To delete an exclude area, click the right mouse button at the relevant area on the screen and click the [OK] button on the delete confirm window.

### Area

When an exclude area is added, the color of number buttons in [Area] will change. When you click the number button, the relevant exclude area will appear from the preview screen.

### Common

Sets the min and max sizes of an object to detect.

### Size

Click the bottom right corner and drag the mouse to change the size. Changing the size also changes the [Minimum] and [Maximum] values under [Size].

**i Note**

- If the ROI and Exclude areas are identical or overlap each other, the Exclude area has priority over the other.
- Any movement smaller than the specified minimum size or larger than the specified maximum size will not be detected. please determine the best values for the minimum/maximum detection sizes that are appropriate for the installation environment in order to avoid any false detection arising out of small and/or large noises. Remember that the same movement in the same spot does not always result in the same detection size. Therefore, it is recommended to allow small/big enough rooms for your minimum/maximum size limits in consideration of the deviation in detected sizes.

---

**Handover**

**Handover**

Select a handover receiver camera number. Select [Off] if you don't want to use the handover function.

Handover is a function that the receiver camera moves to the PTZ preset position when a motion detection event occurs. The handover receiving camera can be set in the [Event] > [Handover] menu.

**i Note**

- You can set the handover receiver camera for each ROI area. The handover function can be used after setting the ROI area first.

---

**Overlay**

Click [Enable] to overlay the detected area on the video screen.

---

**Event action settings**

**FTP**

To save an image on an FTP server when a motion event is created, select [Enable]. Detailed settings for FTP can be done from [Event]>[[FTP/E-mail](#)].

**E-mail**

To send an image by e-mail when a motion detection event is created, select [Enable]. Detailed settings for e-mail can be done from [Event]>[[FTP/E-mail](#)].

**Record**

To save an image on an SD card or NAS when a motion detection event is created, select [Enable]. Detailed settings for storage can be done from [Event]>[[Storage](#)].

**Alarm output**

It is possible to set the alarm output number for a specific alarm when a motion detection event is created. After selecting an alarm output number, select [Off] if you wish no alarm, or select the output time if you wish to output an alarm. You can set a continuous alarm until turned off by the user by selecting [Always] or set the alarm for 5, 10 or 15 seconds.

Depending on the alarm output setup, [Alarm output] options may look different. If there is no alarm output, [Alarm output] options are not displayed. If there is more than one alarm output, they are displayed as [Alarm output 1], [Alarm output 2], and so on. Select [Event]>[Alarm I/O] to set the alarm I/O.

### **Goto preset**

You can set the position of camera view to move to a preset number when a motion detection event is created. The camera preset can be set in [PTZ]>[Digital PTZ] or [Preset] of [External PTZ].

### **Audio clip**

This enables playback of a specific audio clip when a motion detection event occurs. Once you select a file from your audio clip list, the clip will start to play when the event occurs. To disable the audio clip from playing when an event occurs, select [Off]. Clicking the Play button (▶) allows you to play and preview an audio file. Go to [Video & Audio]>[Audio setup]>[Audio clip] to register an audio clip.

---

### **Event activation time**

This sets the action settings set from [Event action settings] to always operate, or only on the set time when a motion detection event is created.

#### **Always**

The set event action settings are always executed when a motion detection event is created.

#### **Only scheduled time**

The event action settings are executed when a motion detection event is created during the set time. The date from Sunday to Saturday, based on the current camera time, is displayed on the time table shown when [Only scheduled time] is selected. You can set the time for event action settings by clicking or dragging on the time table with the mouse. The set event activation time is executed repeatedly on the relevant weekday and time.

You can change the time view unit by clicking the [1 min], [30 min] or [1 h] button. When you click the [Reset] button, all set event activation times will be deleted. To confirm or change the camera time, refer to [Basic]>[Date & Time].

---

## Tampering detection

A tampering detection event can be created when the screen is blocked or the camera position is changed. When you complete the setting, click the [Apply] button at the bottom of the page. The setting on the tampering detection event applies to [Tampering detection] in [Event]>[Event setup] pages equally.

### Tampering detection

#### Enable tampering detection

To use the tampering detection event, select [Enable tampering detection].

#### Level of detection

This sets the standard level of tampering detection. A tampering detection event is created when a tampering of the set level is detected.

Also, when a tampering is detected, a graph showing the level of tampering will appear, and when a tampering detection event is created, the color of the graph will change.

#### Sensitivity

Higher sensitivity results in a more sensitive response of the detection level graph.

#### Minimum duration (s)

This sets the minimum time to detect a tampering and create an event. A tampering detection event is created only when tampering persists for the minimum duration.

#### Except dark images

To exclude a sudden decrease in brightness on the screen, as such in the case of a sudden extinction of lights or blocking of lights, from the tampering detection event, select [Enable].

#### **i** Note

- The detection performance may deteriorate on a uniform background, or in a night-time, low-light environment.
- If the camera shakes too much or if there is sudden change in light, the tampering detection may not function properly.
- It may take up to 5 seconds for a tampering detection event to be created after a tampering occurs.
- When a camera tampering is detected, the function will restart after stabilizing for approximately 5 seconds, and any tampering will not be detected during the stabilization process.
- When an incorrect event is repeatedly being created, errors can be minimized by gradually lowering the level.
- If you set the level of detection too low, then it is possible to trigger an alarm out of quite small changes on the screen, but it can also lead to false detection cause by objects in motion or change in brightness.

---

## Handover

### Handover

Select a handover receiver camera number. Select [Off] if you don't want to use the handover function.

Handover is a function that the receiver camera moves to the PTZ preset position when a tampering detection event occurs. The handover receiving camera can be set in the [Event] > [Handover] menu.

---

## Event action settings

### FTP

To save an image on an FTP server when a tampering detection event is created, select [Enable]. Detailed settings for FTP can be done from [Event]>[FTP/E-mail].

### E-mail

To send an image by e-mail when a tampering detection event is created, select [Enable]. Detailed settings for e-mail can be done from [Event]>[FTP/E-mail].

### Record

To save an image on an SD card or NAS when a tampering detection event is created, select [Enable]. Detailed settings for storage can be done from [Event]>[Storage].

### Alarm output

It is possible to set the alarm output number for a specific alarm when a tampering detection event is created. After selecting an alarm output number, select [Off] if you wish no alarm, or select the output time if you wish to output an alarm. You can set a continuous alarm until turned off by the user by selecting [Always] or set the alarm for 5, 10 or 15 seconds.

Depending on the alarm output setup, [Alarm output] options may look different. If there is no alarm output, [Alarm output] options are not displayed. If there is more than one alarm output, they are displayed as [Alarm output 1], [Alarm output 2], and so on. Select [Event]>[Alarm I/O] to set the alarm I/O.

### Goto preset

You can set the position of camera view to move to a preset number when a tampering detection event is created. The camera preset can be set in [PTZ]>[Digital PTZ] or [Preset] of [External PTZ].

### Audio clip

This enables playback of a specific audio clip when a tampering detection event occurs. Once you select a file from your audio clip list, the clip will start to play when the event occurs. To disable the audio clip from playing when an event occurs, select [Off]. Clicking the Play button (▶) allows you to play and preview an audio file. Go to [Video & Audio]>[Audio setup]>[Audio clip] to register an audio clip.

---

**Event activation time**

This sets the event action from [[Event action settings](#)] to always operate, or only at the set time when a tampering detection event is created.

**Always**

The event action settings are always executed when a tampering detection event is created.

**Only scheduled time**

The event action settings are only executed when a tampering detection event is created during the set time. The date from Sunday to Saturday, based on the current camera time, is displayed on the time table shown when [[Only scheduled time](#)] is selected. You can set the time for event action settings by clicking or dragging on the time table with the mouse. The set event activation time is executed repeatedly on the relevant weekday and time.

You can change the time view unit by clicking the [1 min], [30 min] or [1 h] button. When you click the [[Reset](#)] button, all set event activation times will be deleted. To confirm or change the camera time, refer to [[Basic](#)]>[[Date & Time](#)].



EST.

1998

WE SECURE YOUR LIFE



## Defocus detection

A defocus detection event can be created when defocus of the camera lens is detected. When you complete the setting, click the [Apply] button at the bottom of the page. The setting on the defocus detection event applies to [Defocus detection] on [Event]>[Event setup] page equally.

### Defocus detection

#### Enable defocus detection

To use the defocus detection event, select [Enable defocus detection].

#### Level of detection

This sets the standard level of defocus detection. A defocus detection event is created when defocus beyond the set level is detected.

When defocus is detected, a graph showing the level of defocus will appear, and when a defocus event is created, the graph color will change.

#### Sensitivity

The higher the sensitivity, the higher the level graph is for the same image.

#### Minimum duration (s)

This sets the minimum length of time of defocus for an event to be created. A defocus detection event is created only when a defocus condition persists for the minimum duration.

#### **i** Note

- In order to receive an alarm indicating defocus detection after it has occurred previously, the status must return to the stable status at least once. Instances of returning to the stable status are as follows.
  - When [Enable defocus detection] is deselected
  - When simple focus operates so that an image can be distinguishable
  - When an object in the image moves to a defocus position so that it can be distinguishable
- In any of the following cases, the defocus detection performance may deteriorate, or a malfunction may occur.
  - Monitoring an environment with a monotonous background, at night time, and/or in a low light environment
  - Sudden illumination change (e.g. an indoor light is turned off)
  - Blocked lens or appearance of a large object which covers the most of the screen
  - The object of focus is changed due a change of the camera position

To save an image on an FTP server when a defocus detection event is created, select [Enable]. Detailed settings for FTP can be done from [Event]>[FTP/E-mail].

### E-mail

To send an image by e-mail when a defocus detection event is created, select [Enable]. Detailed settings for e-mail can be done from [Event]>[FTP/E-mail].

### Record

To save an image on an SD card or NAS when a defocus detection event is created, select [Enable]. Detailed settings for storage can be done from [Event]>[Storage].

### Alarm output

It is possible to set the alarm output number for a specific alarm when a defocus detection event is created. After selecting an alarm output number, select [Off] if you wish no alarm, or select the output time if you wish to output an alarm. You can set a continuous alarm until turned off by the user by selecting [Always] or set the alarm for 5, 10 or 15 seconds.

Depending on the alarm output setup, [Alarm output] options may look different. If there is no alarm output, [Alarm output] options are not displayed. If there is more than one alarm output, they are displayed as [Alarm output 1], [Alarm output 2], and so on. Select [Event]>[Alarm I/O] to set the alarm I/O.

### Goto preset

You can set the position of camera view to move to a preset number when a defocus detection event is created. The camera preset can be set in [PTZ]>[Digital PTZ] or [Preset] of [External PTZ].

### Audio clip

This enables playback of a specific audio clip when a defocus detection event occurs. Once you select a file from your audio clip list, the clip will start to play when the event occurs. To disable the audio clip from playing when an event occurs, select [Off].

Clicking the Play button (▶) allows you to play and preview an audio file.

Go to [Video & Audio]>[Audio setup]>[Audio clip] to register an audio clip.

### Simple Focus

Simple focus is executed to adjust the focus automatically when a defocus detection event is created. Simple focus is executed only once when an event is created.

---

### Event activation time

This sets the event action settings from [Event action settings] to always operate, or only at the set time for which a defocus detection event is created.

### Always

The set event action settings are always executed when a defocus detection event is created.

### Only scheduled time

The set event action settings are executed when a defocus detection event is created during the set time. The date from Sunday to Saturday, based on the current camera time, is displayed on the time table shown when [Only scheduled time] is selected. You can set the time for event action settings by clicking or dragging on the time table with the mouse. The set event activation time is executed repeatedly on the relevant weekday and time.

You can change the time view unit by clicking the [1 min], [30 min] or [1 h] button. When you click the [Reset] button, all set event activation times will be deleted. To confirm or change the camera time, refer to [Basic]>[Date & Time].

COLLSAM SECURITY



EST.

1998

WE SECURE YOUR LIFE



## Fog detection

You can correct the image by creating a fog detection event and executing defog in foggy conditions when it is difficult to distinguish the image. When you complete the setting, click the [Apply] button at the bottom of the page. The setting for fog detection events applies to [Fog detection] on [Event]>[Event setup] pages equally.

### Fog detection

#### Enable fog detection

To use fog detection, select [Enable fog detection].

#### Level of detection

The current fog level will appear in the level graph. An alarm occurs when the current level is higher than the set level of detection. A smaller level of detection enables the detection of an image even if it is blurred minutely by fog.

#### Sensitivity

The higher the sensitivity, the higher the level graph is for the same image.

#### Minimum duration (s)

This sets the minimum time between detecting fog and creating an event. An alarm occurs when the level status over the level of detection persists for the set minimum duration.

#### **i** Note

- In order to receive an alarm indicating fog detection after it has occurred previously, the status must return to the stable status at least once. The improvement of image due to defog operation is not recognized as a stable status. Instances of returning to the stable status are as follows.
  - When [Enable fog detection] is deselected
  - When fog or smoke has disappeared to the extent that an image can be distinguishable
- In any of the following cases, the fog detection performance may deteriorate or a malfunction may occur.
  - Monitoring an environment with a monotonous background, at night time, and/or in a low light environment
  - Sudden illumination change (e.g. an indoor light is turned off)
  - Blocked lens or appearance of a large object which covers the most of the screen
  - The object of focus is changed due a change of the camera position

### Event action settings

#### FTP

To save an image on an FTP server when a fog detection event is created, select [Enable]. Detailed settings for FTP can be done from [Event]>[FTP/E-mail].

### E-mail

To send an image by e-mail when a fog detection event is created, select [Enable]. Detailed settings for e-mail can be done from [Event]>[FTP/E-mail].

### Record

To save an image on an SD card or NAS when a fog detection event is created, select [Enable]. Detailed settings for storage can be done from [Event]>[Storage].

### Alarm output

It is possible to set an alarm output number for a specific alarm when a fog detection event is created. After selecting an alarm output number, select [Off] if you wish no alarm, or select the output time if you wish to output an alarm. You can set a continuous alarm until turned off by the user by selecting [Always] or set the alarm for 5, 10 or 15 seconds.

Depending on the alarm output setup, [Alarm output] options may look different. If there is no alarm output, [Alarm output] options are not displayed. If there is more than one alarm output, they are displayed as [Alarm output 1], [Alarm output 2], and so on.

Select [Event]>[Alarm I/O] to set the alarm I/O.

### Goto preset

You can set the position of camera view to move to a preset number when a fog detection event is created. The camera preset can be set in [PTZ]>[Digital PTZ] or [Preset] of [External PTZ].

### Defog

To execute defog when a fog detection event is created, select [Enable].

### Audio clip

This enables playback of a specific audio clip when a fog detection event occurs. Once you select a file from your audio clip list, the clip will start to play when the event occurs. To disable the audio clip from playing when an event occurs, select [Off].

Clicking the Play button (▶) allows you to play and preview an audio file.

Go to [Video & Audio]>[Audio setup]>[Audio clip] to register an audio clip.

---

### Event activation time

This sets the event action set from [Event action settings] to always operate, or only at a set time when a fog detection event is created.

### Always

The set event action settings are always executed when a fog detection event is created.

### Only scheduled time

The set event action settings are executed when a fog detection event is created during the set time. The date from Sunday to Saturday, based on the current camera time, is displayed on the time table shown when [Only scheduled time] is selected. You can set the time for event action settings by clicking or dragging on the time table with the mouse. The set event activation time is executed repeatedly on the relevant weekday and time.

You can change the time view unit by clicking the [1 min], [30 min] or [1 h] button. When you click the [Reset] button, all set event activation times will be deleted. To confirm or change the camera time, refer to [Basic]>[Date & Time].



## Face/upper body detection

A face/upper body detection event can be created when a face or an upper body is detected within the area designated by the user while the camera is capturing an image. When you complete the setting, click the [Apply] button at the bottom of the page. The setting on face/upper body detection events applies to [Face/upper body detection] on [Event]>[Event setup] page equally.

### Face/upper body detection Enable face/upper body detection

To use the face/upper body detection event, select [Enable face/upper body detection].

### Area

#### Setting an area

Of the whole screen, a area selected by the user can be set as the area. The minimum face/upper body detection size is displayed as a face icon in the detection area. Any face which is larger than the face icon is detected in the detection area.

#### Changing an area

You can change the size of the detection area by clicking the bottom right corner of the set area and dragging the relevant area with the mouse.

#### Sensitivity

This sets the sensitivity of the face/upper body detection event. The higher the sensitivity, the more detailed the face/upper body detection that is possible.

#### Motion based dynamic area

Select [Enable] if you want the face/upper body detection area to be automatically changed according to the motion analysis. If [Enable] is not selected, faces will be detected only in the set ROI area.

If the ROI area is set, the face will be detected only within the set area, and the detection efficiency of the small face at a long distance may be deteriorated. If 'Motion based dynamic area' function is used, when motion is detected on the whole screen, area for face/upper body detection is automatically changed, and thus the face/upper body detection efficiency is improved.

#### **i** Note

- When the 'Motion based dynamic area' function is used, only the area where motion occurs is designated as the face/upper body detection area.
- Continuous face/upper body detection is impossible because the detection area is actively changed to detect faces in various areas.

### Exclude area

#### Setting an exclude area

Of the whole screen, a area selected by the user can be set as the exclude area. When you select 4 corners of the image with the mouse, the area is set as the exclude area and the color of the number buttons on [Area] changes. Up to 8 exclude areas can be set.

### Changing an exclude area

You can change the size of the exclude area by clicking the corner of the current exclude area and dragging the relevant area with the mouse.

### Deleting an exclude area

To delete an exclude area, click the right mouse button at the relevant area on the screen and click the [OK] button on the delete confirm window.

### Area

When an exclude area is added, the color of the number button will also change. When you click the number button, the relevant exclude area will disappear from the preview screen. When you click the number button again, the exclude area will reappear.

#### **i** Note

- If the detection area and the exclude area are identical or overlap, the exclude area has priority.

### Overlay

Click [Enable] to overlay the detected area on the video screen.

### Event action settings

#### FTP

To save an image on an FTP server when a face/upper body detection event is created, select [Enable]. Detailed settings for FTP can be done from [Event]>[FTP/E-mail].

#### E-mail

To send an image by e-mail when a face/upper body detection event is created, select [Enable]. Detailed settings for e-mail can be done from [Event]>[FTP/E-mail].

#### Record

To save an image on an SD card or NAS when a face/upper body detection event is created, select [Enable]. Detailed settings for storage can be done from [Event]>[Storage].

### Alarm output

It is possible to set an alarm output number for a specific alarm when a face/upper body detection event is created. After selecting an alarm output number, select [Off] if you wish no alarm, or select the output time if you wish to output an alarm. You can set a

continuous alarm until turned off by the user by selecting [Always] or set the alarm for 5, 10 or 15 seconds.

Depending on the alarm output setup, [Alarm output] options may look different. If there is no alarm output, [Alarm output] options are not displayed. If there is more than one alarm output, they are displayed as [Alarm output 1], [Alarm output 2], and so on. Select [Event]>[Alarm I/O] to set the alarm I/O.

### Goto preset

You can set the position of camera view to move to a preset number when a face/upper body detection event is created. The camera preset can be set in [PTZ]>[Digital PTZ] or [Preset] of [External PTZ].

### Audio clip

This enables playback of a specific audio clip when a face/upper body detection event occurs. Once you select a file from your audio clip list, the clip will start to play when the event occurs. To disable the audio clip from playing when an event occurs, select [Off]. Clicking the Play button (▶) allows you to play and preview an audio file. Go to [Video & Audio]>[Audio setup]>[Audio clip] to register an audio clip.

### Event activation time

This sets the operation time of the face/upper body detection event action settings. Set the event action settings from [Event action settings] to always operate, or only at the set time.

#### Always

The set event action settings are always executed when a face/upper body detection event is created.

#### Only scheduled time

The set event action settings are executed when a face/upper body detection event is created during the set time. The date from Sunday to Saturday, based on the current camera time, is displayed on the time table shown when [Only scheduled time] is selected. You can set the time for event action settings by clicking or dragging on the time table with the mouse. The set event activation time is executed repeatedly on the relevant weekday and time.

You can change the time view unit by clicking the [1 min], [30 min] or [1 h] button. When you click the [Reset] button, all set event activation times will be deleted. To confirm or change the camera time, refer to [Basic]>[Date & Time].

## IVA

An IVA event can be created when the rule for video analytics is set and a motion which satisfies the event rule condition is detected. When you complete the setting, click the [Apply] button at the bottom of the page. The setting on the IVA event applies to [IVA] on [Event]>[Event setup] pages equally.

### IVA (Intelligent Video Analytics)

#### Enable IVA

To use the IVA event, select [Enable IVA].

### Virtual line

Detects passing objects based on the virtual line and its direction configured by the user.

#### Setting a virtual line

When you click the start point and the end point of the line at each desired position on the camera image screen, the virtual line will be set and the color of the number button in [Line] will change.

You can change the direction from A to B, B to A or both directions by clicking the arrow in the middle of the virtual line, or you can select a desired direction from [Direction] in [Categories]. Up to 8 virtual lines can be set.

#### Changing a virtual line

You can change the size of the virtual line by moving a corner of the set virtual line. You can change the position of the virtual line by clicking and dragging the virtual line with the mouse.

#### Deleting a virtual line

To delete a virtual line, click the right mouse button at the relevant area on the screen and click the [OK] button on the delete confirm window.

#### Line

When a virtual line is added, the color of the number buttons in [Line] will change.

When you disable a virtual line by clicking the number buttons, the relevant virtual line will be displayed on the preview screen.

#### Categories

- Crossing: To create an event when an object which passes the set virtual line is detected, select the check box.
- Direction: This sets the direction for an object to pass the virtual line.

### Virtual area

The user sets the virtual area and applies the image rule of intrusion, enter/exit, appear (disappear) and loitering in the relevant area to detect the motion of an object.

#### Setting a virtual area

On the preview screen, use your mouse to select 4 corners or drag to draw a quadrilateral shape which will then be your ROI area.  
Up to 8 virtual areas can be set and an image analysis rule can be set for each area.

### Changing a virtual area

You can change the size of the virtual area by moving a corner of the set virtual area.  
To create a polygon (N-gon), first select and create a quadrilateral. When a + sign appears, click it to add another point. You can add up to 4 additional points to create a polygon of your choice.  
To move the set virtual area, click and drag the relevant area with the mouse. When a corner is created after clicking a line, you can set a polygonal virtual area by moving the corner.

### Deleting a virtual area

To delete a virtual area, click the right mouse button at the relevant area on the screen and click the [OK] button on the delete confirm window.

### Area

When a virtual area is added, the color of the number buttons in [Area] will change.  
When you disable a virtual area by clicking the number buttons, the relevant virtual area will be displayed on the preview screen.

### Categories

You can set the rule to apply for each virtual area.

- Intrusion: When an object moves inside the set area, an event will be created.
  - Minimum duration (s): Sets the minimum amount of time to trigger an event after detection. When the movement lasts longer than the set period of time, the event is triggered.
- Enter: When an object enters the area set by the user, an event will be created.
- Exit: When a moving object exits the area set by the user, an event will be created.
- Appear (Disappear): When an object which does not exist inside the area designated by the user appears inside the area without passing the area line and remains for a certain period of time, or if an object which exists inside the area disappears, an event will be created.
  - Minimum duration (s): This sets the minimum timeframe for an object to be detected as appearing (disappearing). When an object which exists in the detection area for the set time disappears, it is detected as disappearing, and when an object which does not exist appears for the set amount of time, it is detected as appearing.
- Loitering: When a loitering object in the set detection area is detected, an event will be created.
  - Minimum duration (s): This sets the minimum length of time for a loitering object to be detected and an event created. When an object which loiters longer than the set time is detected, an event will be created.

### **i** Note

- When loitering detection is used together with other IVA event detection, the performance may deteriorate to a certain degree in comparison with separate use of loitering detection.
- In the cases below, the loitering detection function may not work as the camera considers the object disappeared.
  - When a loitering object overlaps with another object
  - When an object that was loitering stops in a place for some time

- When the environment is complex and there is a moving object in proximity to the loitering object

## Exclude area

This sets the exclude area where motion will not be detected when the analytics rule is applied to the virtual line and the virtual area.

### Setting an exclude area

On the preview screen, use your mouse to select 4 corners or drag to draw a quadrilateral shape which will then be your Exclude area. Up to 8 exclude areas can be set.

### Changing an exclude area

You can change the size of an exclude area by moving a corner of the set exclude area. To create a polygon (N-gon), first select and create a quadrilateral. When a + sign appears, click it to add another point. You can add up to 4 additional points to create a polygon of your choice. You can move the position of an exclude area by selecting and dragging the exclude area with the mouse.

### Deleting an exclude area

To delete an exclude area, click the right mouse button at the relevant area on the screen and click the [OK] button on the delete confirm window.

## Area

When an Exclude area is added, the color of the number buttons in [Area] will change one by one. If you click the number buttons to deactivate them, then the Exclude area will be selected on the preview screen.

## Common

This sets the sensitivity and the minimum and maximum size of an object to be detected that will be applied to both the virtual line and the virtual area.

This is a setting you can apply to raise the detection accuracy and minimize the occurrence of false detection depending on your environment.

### Sensitivity

This sets the motion detection sensitivity for the virtual line and the virtual area. Set a lower sensitivity for an environment where the background and an object are clearly distinguishable and a higher sensitivity for an environment where the background and an object are not clearly distinguishable.

### Size

This sets the minimum and maximum size of an object to be detected that will be applied to both the virtual line and the virtual area. You can change the size by clicking and dragging a corner with the mouse. When the size is changed, [Minimum] and [Maximum] in [Size] also change.

### **i** Note

- If the detection area and the exclude area are identical or overlap, the exclude area has priority.
- Any movement smaller than the specified minimum size or larger than the specified maximum size will not be detected. please determine the best values for the minimum/maximum detection sizes that are appropriate for the installation environment in

order to avoid any false detection arising out of small and/or large noises. Remember that the same movement in the same spot does not always result in the same detection size. Therefore, it is recommended to allow small/big enough rooms for your minimum/maximum size limits in consideration of the deviation in detected sizes.

## Handover

### Handover

Select a handover receiver camera number. Select [Off] if you don't want to use the handover function.

Handover is a function that the receiver camera moves to the PTZ preset position when an IVA event occurs. The handover receiving camera can be set in the [Event] > [Handover] menu.

#### Note

- You can set the handover receiver camera for each virtual line and ROI area. You can use the handover function after setting the virtual line or ROI area first.

## Overlay

Click [Enable] to overlay the detected area on the video screen.

## Event action settings

### FTP

To save an image on an FTP server when an IVA event is created, select [Enable]. Detailed settings for FTP can be done from [Event]>[FTP/E-mail].

### E-mail

To send an image by e-mail when an IVA event occurs, select [Enable]. Detailed settings for e-mail can be done from [Event]>[FTP/E-mail].

### Record

To save an image on an SD card or NAS when an IVA event is created, select [Enable]. Detailed settings for storage can be done from [Event]>[Storage].

### Alarm output

It is possible to set the alarm output number for a specific alarm when an IVA event is created. After selecting an alarm output number, select [Off] if you wish no alarm, or select the output time if you wish to output an alarm. You can set a continuous alarm until turned off by the user by selecting [Always] or set the alarm for 5, 10 or 15 seconds.

Depending on the alarm output setup, [Alarm output] options may look different. If there is no alarm output, [Alarm output] options are not displayed. If there is more than one alarm output, they are displayed as [Alarm output 1], [Alarm output 2], and so on. Select [Event]>[Alarm I/O] to set the alarm I/O.

### Goto preset

You can set the position of camera view to move to a preset number when an IVA event is created. The camera preset can be set in [PTZ]>[\[Digital PTZ\]](#) or [Preset] of [\[External PTZ\]](#).

### Audio clip

This enables playback of a specific audio clip when an IVA event occurs. Once you select a file from your audio clip list, the clip will start to play when the event occurs. To disable the audio clip from playing when an event occurs, select [Off]. Clicking the Play button (▶) allows you to play and preview an audio file.

Go to [Video & Audio]>[\[Audio setup\]](#)>[Audio clip] to register an audio clip.

### Event activation time

This sets the operation time of the IVA event action settings. Set the event action settings from [\[Event action settings\]](#) to always operate, or only at the set time.

#### Always

The event action settings are always executed when an IVA event is created.

#### Only scheduled time

The event action settings are executed only when an IVA event is created during the set time. The date from Sunday to Saturday, based on the current camera time, is displayed on the time table shown when [Only scheduled time] is selected. You can set the time for event action settings by clicking or dragging on the time table with the mouse. The set event activation time is executed repeatedly on the relevant weekday and time.

You can change the time view unit by clicking the [1 min], [30 min] or [1 h] button. When you click the [Reset] button, all set event activation times will be deleted. To confirm or change the camera time, refer to [Basic]>[\[Date & Time\]](#).

EST.

1998

WE SECURE YOUR LIFE



## Audio detection

An audio detection event can be created when audio above a set level is detected while the camera is capturing an image. When you complete the setting, click the [Apply] button at the bottom of the page. The setting on the audio detection event applies to [Audio detection] on the [Event]> and [Event setup] page equally.

### Audio detection

#### Enable audio detection

To apply the audio detection event, select [Enable audio detection].

#### Level of detection

This sets the level standard for audio detection. An audio detection event is created when audio above the set level is detected.

When audio is detected, a graph will appear, and when an audio detection event is created, the graph color will change.

#### **i** Note

- The lower the level of detection is, the smaller change in sound it can detect.
- The audio level of detection value is designed to detect a sound at the threshold level or higher by normalizing the input data to a value between 1 and 100, and it is irrelevant to the decibel (dB) values.
- Go to [Video & Audio]>[Audio setup]>[Source] to select Microphone and set the sufficient level of sound so that the audio detection function can operate properly.
- Audio gain can be set from [Video & Audio]>[Audio setup]>[Gain].

### Event action settings

#### FTP

To save an image on an FTP server when an audio detection event occurs, select [Enable]. Detailed settings for FTP can be done from [Event]>[FTP/E-mail].

#### E-mail

To send an image by e-mail when an audio detection event is created, select [Enable]. Detailed settings for e-mail can be done from [Event]>[FTP/E-mail].

#### Record

To save an image on an SD card or NAS when an audio detection event is created, select [Enable]. Detailed settings for storage can be done from [Event]>[Storage].

#### Alarm output

It is possible to set an alarm output number for a specific alarm when an audio detection event is created. After selecting an alarm output number, select [Off] if you wish no alarm, or select the output time if you wish to output an alarm. You can set a continuous alarm until turned off by the user by selecting [Always] or set the alarm for 5, 10 or 15 seconds.

Depending on the alarm output setup, [Alarm output] options may look different. If there is no alarm output, [Alarm output] options are not displayed. If there is more than one alarm output, they are displayed as [Alarm output 1], [Alarm output 2], and so on. Select [Event]>[Alarm I/O] to set the alarm I/O.

### **Goto preset**

You can set the position of camera view to move to a preset number when an audio detection event is created. The camera preset can be set in [PTZ]>[Digital PTZ] or [Preset] of [External PTZ].

---

### **Event activation time**

This sets the event action settings from [Event action settings] to operate always or only at a set time, when an audio detection event is created.

#### **Always**

The set event action settings are always executed when an audio detection event is created.

#### **Only scheduled time**

The set event action settings are executed when an audio detection event occurs during the set time. The date from Sunday to Saturday, based on the current camera time, is displayed on the time table shown when [Only scheduled time] is selected. You can set the time for event action settings by clicking or dragging on the time table with the mouse. The set event activation time is executed repeatedly on the relevant weekday and time.

You can change the time view unit by clicking the [1 min], [30 min] or [1 h] button. When you click the [Reset] button, all set event activation times will be deleted. To confirm or change the camera time, refer to [Basic]>[Date & Time].

---

WE SECURE YOUR LIFE



## Sound classification

The type of sound detected while the camera is capturing an image can be classified and created as a sound classification event. When you complete the setting, click the [Apply] button at the bottom of the page. The setting on the sound classification event applies to [Sound classification] on the [Event]>[Event setup] pages equally.

### Sound classification

#### Enable sound classification

To use the sound classification event, select [Enable sound classification].

### Configuration

#### Noise filter

To use the noise removal filter, select [Enable]. If the noise from the surrounding environments is higher than 55dB~65dB, use [Noise filter]. Using the noise reduction function according to environments reduces original sound so that the sound classification performance may deteriorate, or a malfunction may occur. If the noise reduction filter is used in a quiet environment, the sound classification performance may deteriorate.

#### Level of classification

Sets the level of audio energy to classify the sound. The level value of input audio energy is drawn on the area while being renewed periodically from right to left. The sound classification applies only to audio over the set level. In other words, it is classified as the sound source only when the energy of the audio input is higher than the reference line. If the reference line is lowered, there is more target data for the sound classification, and a higher possibility of false detections. If the reference line rises, there are less target data for the sound classification and a higher probability of missing detections. Set it properly according to the surrounding noise level.

#### Categories

This detects the type of sound and creates an event. The type of sound to detect can be selected and can be selected repeatedly.

- **Scream:** Triggers an event by detecting a sudden loud sound, including a scream or shout made by a person such as an adult male, female, or child.
- **Gunshot:** Triggers an event by detecting a gunshot that does not occur repeatedly.
- **Explosion:** Triggers an event by detecting a sudden sound caused by destruction.
- **Crashing glass:** Triggers an event by detecting the sound of breaking glass.

#### **i** Note

- If [Line] is set for [Source] in [Video & Audio]>[Audio setup]>[Audio in], the sound classification function does not operate.
- It is recommended to set a number between 4 and 6 for [Gain] in [Video & Audio]>[Audio setup]>[Audio in].

- If [External microphone] is set for [Source] in [Video & Audio]>[Audio setup]>[Audio in], the recommended specifications of the microphone are as follows. (If the microphone is out of spec, then the sound classification function might not work well.)
  - Frequency range: 40 ~ 16,000Hz
  - Impedance: 1,500 Ω
  - Sensitivity: -40±3 dB (7.1~14.1 mV)
- In any of the following cases, the sound classification performance may deteriorate or a malfunction may occur.
  - When repeated gunshots occur, such as the sound of machine gun, only one time gunshot is included in the category for the gunshot
  - When the sound is too large, so that noise and the target sound cannot be distinguished
  - When two or more different sounds are inputted at the same time
  - When the object of focus has changed due to camera position change
  - If the noise removal function is used in a quiet place and the sound classification is applied
  - If the source of clapping sounds or screams is close to the camera (within 1 meter)
  - If a sound that does not belong to the sound classification categories, such as airplanes sounds, siren sounds, is loudly heard all of sudden

## Handover

### Handover

Select a handover receiver camera number. Select [Off] if you don't want to use the handover function.

Handover is a function that the receiver camera moves to the PTZ preset position when a sound classification event occurs. The handover receiving camera can be set in the [Event] > [Handover] menu.

## Event action settings

### FTP

To save an image on an FTP server when a sound classification event is created, select [Enable]. Detailed settings for FTP can be done from [Event]>[FTP/E-mail].

### E-mail

To send an image by e-mail when a sound classification event is created, select [Enable]. Detailed settings for E-mail can be done from [Event]>[FTP/E-mail].

### Record

To save an image on an SD card or NAS when a sound classification event is created, select [Enable]. Detailed settings for storage can be done from [Event]>[Storage].

### Alarm output

It is possible to set the alarm output number for a specific alarm when a sound classification event is created. After selecting an alarm output number, select [Off] if you wish no alarm, or select the output time if you wish to output an alarm. You can set a continuous alarm until turned off by the user by selecting [Always] or set the alarm for 5, 10 or 15 seconds.

Depending on the alarm output setup, [Alarm output] options may look different. If there is no alarm output, [Alarm output] options are not displayed. If there is more than one alarm output, they are displayed as [Alarm output 1], [Alarm output 2], and so on.

Select [Event]>[Alarm I/O] to set the alarm I/O.

### Goto preset

You can set the position of camera view to move to a preset number when a sound classification event is created. The camera preset can be set in [PTZ]>[Digital PTZ] or [Preset] of [External PTZ].

---

### Event activation time

This sets the settings from [Event action settings] to always operate, or only on the set time when a sound classification event is created.

#### Always

The set event action settings are always executed when a sound classification event is created.

#### Only scheduled time

The set event action settings are executed only when a sound classification event is created during the set time. The date from Sunday to Saturday, based on the current camera time, is displayed on the time table shown when [Only scheduled time] is selected. You can set the time for event action settings by clicking or dragging on the time table with the mouse. The set event activation time is executed repeatedly on the relevant weekday and time.

You can change the time view unit by clicking the [1 min], [30 min] or [1 h] button. When you click the [Reset] button, all set event activation times will be deleted. To confirm or change the camera time, refer to [Basic]>[Date & Time].

EST.

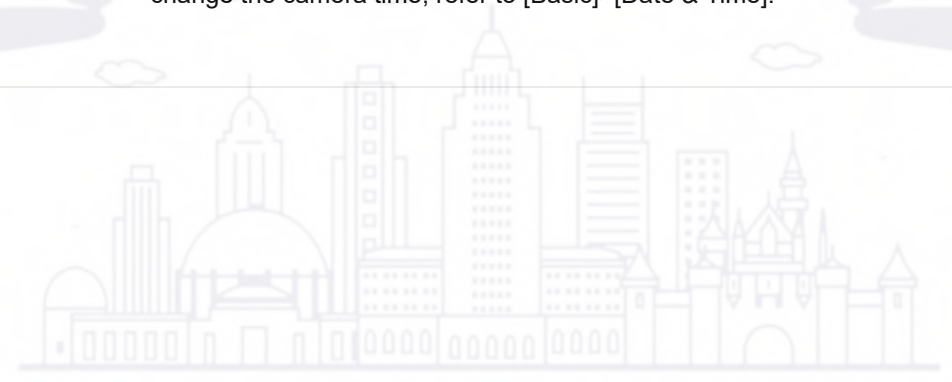

1998

WE SECURE YOUR LIFE



## Search

People counting counts the number of people who pass a virtual line through the camera image analysis. You can search and confirm statistical data for the number of people counted by condition and time in people counting 'Search'.

### **i** Note

- In order to use the search function in people counting, you need to select [Enable people counting] from [Statistics]>[People counting]>[Setup] and set the people counting rule.

## Search

Statistics for the number of people entered by the people counting rule or count type are shown.

The rule line set from [Statistics]>[People counting]>[Setup] is shown on the screen. Also, the data for the number of people counted according to each count method (IN or OUT) by rule is shown in a table. The number in the table is the total number of people counted from 00:00 to the current time today. [Rule name] in the table is set from [Statistics]>[People counting]>[Setup]. [IN] shows the number of people who moved in the direction of the arrow in the rule line, and [OUT] shows the number of people who moved in the opposite direction.

### Today

The number of people counted from 00:00 to 24:00 is shown in a graph by hour.

There are 4 options in the combination of rule name and count type (IN and OUT) as 'rule name-IN' and 'rule name-OUT'. When an option is selected, the relevant graph will be shown in Cyan. If you place the mouse on top of the graph, a balloon showing the number of people at the selected time will appear.

### Weekly

The trend for the number of people by date for the last 7 days, based on today, is shown in a graph.

There are 4 options in the combination of rule name and count type (IN and OUT) as 'rule name-IN' and 'rule name-OUT'. When an option is selected, the relevant graph will be shown in Cyan. If you place the mouse on top of the graph, a balloon showing the information regarding the number of people on the selected date in an exact numerical value will appear.

## Search

### Date

When you select [Recent], you can search by one recent day, week or month based on the current time.

When you select [Period], you can specify a period by day, month or year and search. Select the calendar icon to change the date.

## Rule

Select the rule condition to search. Select the rule condition by combining the rule (Rule 01 and Rule 02) and the count method (IN and OUT) of the relevant rule. For example, if you select the check box where 'Rule 01' and 'IN' meet, the number of people who passed in the arrow direction in the rule line specified in 'Rule 01' is searched. If you select the check box where 'Rule 02' and 'OUT' meet, the number of people who passed in the opposite direction of the arrow in the rule line specified in 'Rule 02' is searched.

The rule can be set in [Statistics]>[People counting]>[Setup].

### Search people counting data

1. Select the date you wish to search from [Date] in [Search].
2. Select a rule you wish to search and the counting method of each rule in [Rule]. For example, if you wish to search for the number of people who moved in the direction specified in 'Rule 01', select the check box where 'Rule 01' and 'IN' meet.
3. Click the [Search] button. The search results will be displayed in [Results].

## Results

If you search people counting data, the results will be shown in a graph and a table. If you search 'one recent day', data by hour from 00:00 to 24:00 today will be shown. If you search 'one recent week', data by date from the 7 days immediately previous to today will be shown. If you search 'one recent month', data by date for the 30 days immediately previous to today will be shown.

If you select 'Period' and designate a specific day, month and year, data by hour from 00:00 to 24:00 for the designated date and data by date for the designated month and year will be shown.

People counting data is shown separately as 'Rule name-IN' and 'Rule name-OUT' as the combination of the rule name and count method (IN and OUT). If you select the option from a graph, only the relevant graph will be shown in Cyan. Also, if you place the mouse on top of a graph, a balloon showing the data at the selected time in an exact numerical value will appear.

### Note

- Searched data refreshes every 15 minutes. The search results may differ from the real time results shown on the [Setting] page.

## Download

When you click the [Download] button after searching, you can download the search results. The search results can be downloaded in .txt file formats, and the downloaded file will be saved in the browser's default save path. Up to 64 characters, including letters and numbers, can be entered for the file name.

## Setup

People counting counts the number of people who pass a virtual line through the camera image analysis. The conditions for counting the number of people and detailed items for improving the accuracy of people counting are set from 'Setup' in people counting. When you complete the setting, click the [Apply] button at the bottom of the page.

### Setup

#### Enable people counting

To use the people counting function, select [Enable people counting].

### Configuration

Set the counting rule for counting the number of people. Up to 2 people counting rules can be set.

#### Setting the counting rule

To set a counting rule, select the check box in [Rule] and enter the rule name in the [Name] field. Up to 15 characters, including letters and numbers, can be entered for the rule name. The entered name is shown in [Statistics]>[People counting]>[Search].

#### Setting the count type

The types for counting the number of people in people counting are IN count and OUT count. When you select the check box in [Rule], the rule line will appear in the image. IN count applies to people who move in the direction of the arrow on the line and OUT count applies to people who move in the opposite direction. Clicking the arrow on the rule line changes its direction.

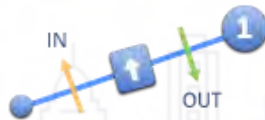

#### Setting the rule line

The people counting function counts the number of people who pass the rule line. To change the position of the rule line, click the rule line shown in the image and drag it using the mouse. You can adjust the length of the line by dragging a corner located at either end of the rule line. If you select and activate the rule, the real time count is displayed at the bottom of the video. Real time counting resets at every 00:00.

#### Activating and deactivating the people counting rule

To enable the counting rule, select the check box of the desired rule from [Rule]. To disable the counting rule, deselect the check box of the desired rule from [Rule]. The people counting rule setting remains intact, so if you select the check box again, the original rule function will be re-activated.

### Exclude area

Set to not count the number of people who enter an area specified by the user.

#### Setting an exclude area

When you select the 4 corners of an image with the mouse, the area is set as the exclude area, and the color of the number buttons in [Area] changes. Up to 4 exclude areas can be set.

### Changing an exclude area

You can adjust the size of an exclude area by clicking and moving a corner or a line of the exclude area. To move an exclude area, click and drag the relevant area with the mouse.

### Deleting an exclude area

To delete an exclude area, click the right mouse button at the relevant area on the screen and click the [OK] button on the delete confirm window.

### Area

When you click a number button in [Area], the relevant area will be selected in the image. The edge of the selected area will appear with a thick white line.

### Calibration

Set the camera or the human height to count in order to improve the accuracy of people counting. You can only select and apply either the camera height or the human height.

### Size

Specify the height of people to count. You can adjust the height by dragging the corner at the bottom right of the box displayed on the image screen.

#### Note

The value set on [People counting] > [Calibration] applies equally to [People counting] and [Heatmap] functions.

Calibration is required for improving the accuracy of people counting. Inaccurate calibration information can have negative impact on the accuracy of people counting.

**Real-time people counting data** The sum of the number of people counted in real time according to the set rule and the count type of each rule will be shown in a table.

### Report

#### Enable

To receive people counting data periodically through e-mail and FTP, select [Enable]. Detailed settings for FTP and e-mail can be done from [Event]>[FTP/E-mail].

#### Schedule

To receive people counting data at the same time every day, select [Daily] and choose a time.

To receive people counting data on the same weekday and time every week, select [Weekly] and select a weekday and a time.

### File name

Enter the file name for sending people counting data through an FTP server or e-mail and select the file format. Up to 64 characters, including letters and numbers, can be entered for the file name.

### Event activation time

You can set People Counting to work always or set it to work at a scheduled time only. When it is activated, People Counting data at that time is collected.

#### Always

People Counting always works.

#### Only scheduled time

People Counting is activated at the scheduled time only. If you select [Only scheduled time], the timetable will display the dates from Sunday to Saturday based on the current camera time. You can set the action time of People Counting by clicking or dragging the mouse in the timetable. The set schedule works repeatedly on the set day and time. You can change the time viewing unit by clicking the [1 min], [30 min], or [1 h] button. Clicking the [Reset] button deletes all set schedules. To check or change the camera time, see [Basic]>[Date & Time].

### Delete all data

To delete all people counting data, click [Delete all data].

#### **i** Note

- In the following cases, it is recommended that you reset the rule to match the changed video screen and click [Delete all data] to delete the old data used for the people counting search.
  - If you have changed the settings in [Video & Audio] > [Video Setup] > [Video Rotation]
  - If you change the settings in [Video & Audio] > [Camera Setup] > [Special] > [DIS]

#### **i** Note

The people counting function aims at supplying statistical data but not data with real time accuracy, and it may include moving objects or animals in the total measured number of units.

After installing the camera, it may continue to malfunction until it is stabilized. The time for stabilization may take up to 50 to 60 minutes.

In any of the following cases, errors in the measured data are likely to increase:

If installed in a space with no sufficient visions

Night time or low brightness (Figure 1)

In an environment with a sudden change in light, or in case of exposure to strong light, such as direct sunlight, sunset, sunrise, direct lighting, etc. (Figure 2)

If there is consistent movement at the fixed location such as near the door (Figure 3)

If many people move in a group

If moving object is close to the set rule,

If the rule is set at the outer edge of image for a fisheye camera (Figure 4)

A camera to operate people counting requires that the lens to be installed on the ground in a direct drop. (Figure 5)

In you set the object size to a value greater than the actual size in calibration, the measurement results can yield a less number of people than actual; on the contrary, if you set it to a smaller number, then it can yield a greater number of people than actual.

Figure 1

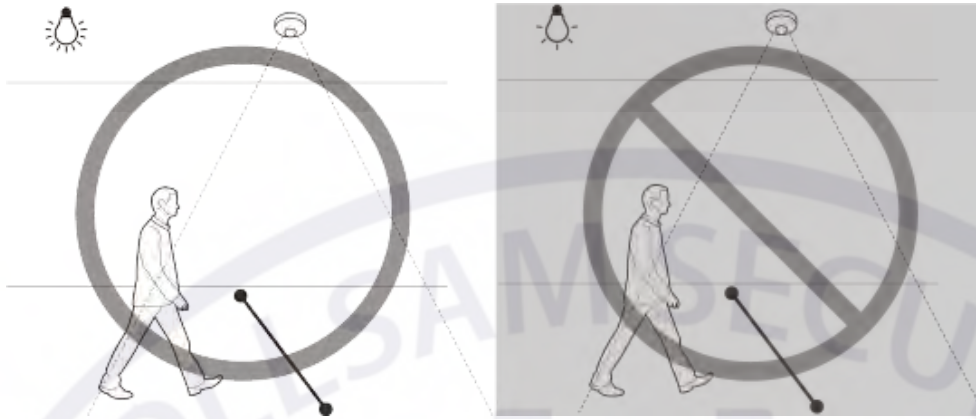

Figure 2

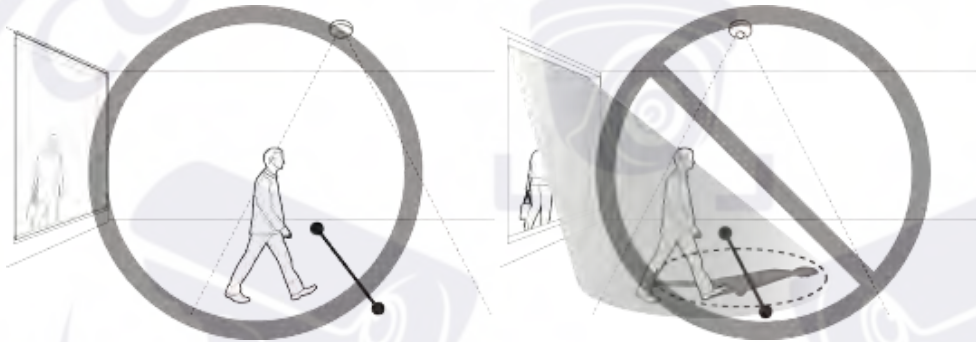

Figure 3

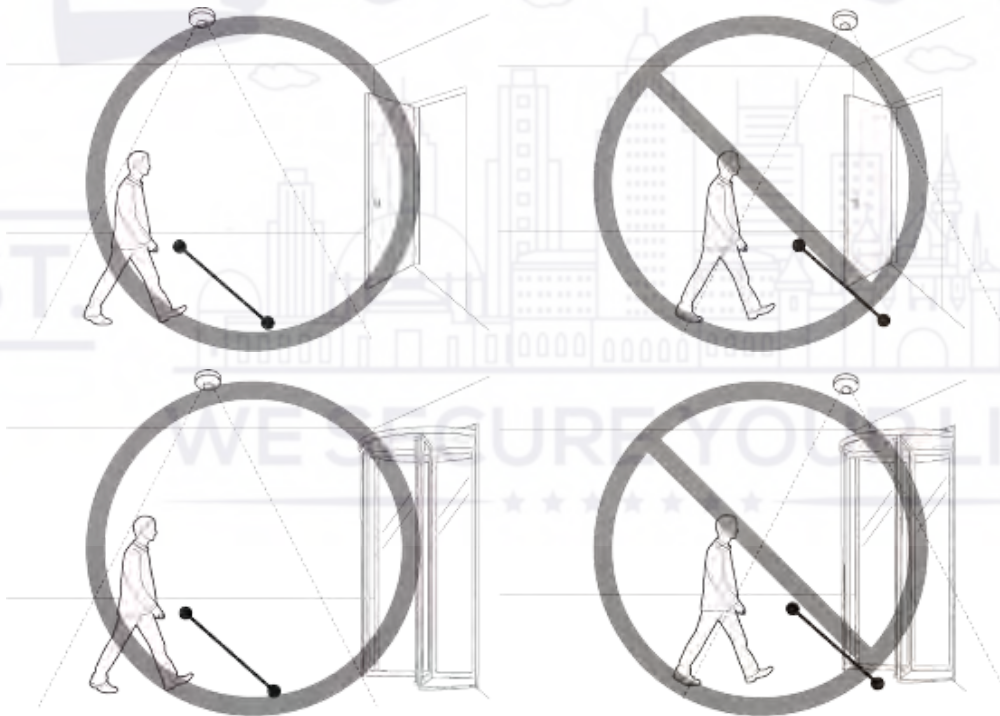



Figure 4

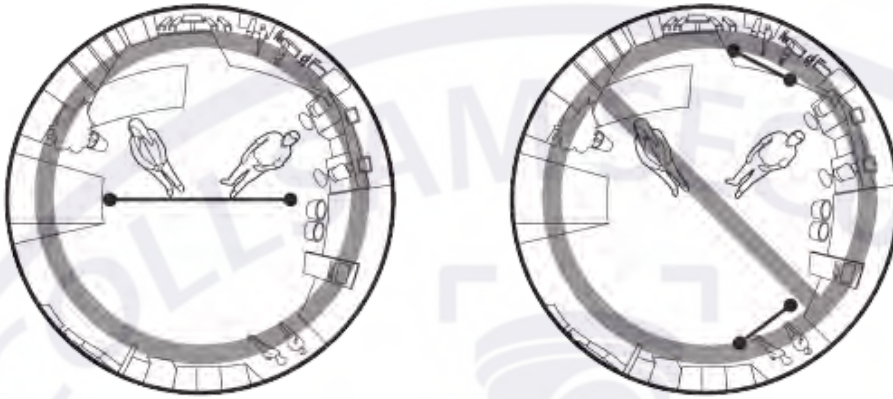

Figure 5



EST.

1998

WE SECURE YOUR LIFE



## Search

Queue management is a function used to monitor the average number of people staying in a specified area and the total time of stay through an analysis of camera images. The number of queuing people and statistical data of queuing time can be searched and viewed from the 'Search' page of Queue management.

### **i** Note

- In order to use the search function in queue management, you must select [Enable queue management] from [Statistics]>[Queue management]>[Setup] and set the queue management area.

## Search

The queue rule set from [Statistics]>[Queue management]>[Setup] is displayed on the screen.

### Occupancy

Real-time analysis data for each queue rule is shown.

### Today

#### Average number of people

The number of people counted in each queue rule from 00:00 to 24:00 is shown in a graph displayed by hour.

When you select the name of a queue rule located at top right side of the graph, only the relevant graph will be shown in cyan. If you place the mouse on top of the graph, a balloon showing the number of people at the selected time will appear.

#### Total time

The total queuing time is analyzed by the queue rules and the detection levels (high and middle), and it is shown in the graph.

The level of detection is specified in [Level of detection] on the [Setup] page, and the level of queuing is classified into 'High' and 'Medium', according to the number of people in the queue.

For example, 'Queue 1- High' indicates the total time during which there is a large number of queuing people in 'Queue 1' as the 'High' level of detection, and 'Queue 1- Medium' indicates the total time during which there is a large number of queuing people in 'Queue 1' as the 'Medium' level of detection.

## Weekly

The trend for the average number of people by queue and date for the last 7 days, based on today, is shown in a graph.

If you place the mouse on top of the graph, a balloon showing the information regarding the number of people on the selected date will be displayed in an exact numerical value.

## Search

### Date

When you select [Recent], you can search by one day, week, or month from the current time.

When you select [Period], you can specify a period by day, month, or year and search accordingly. Select the calendar icon to change the date.

### Rule

Select the conditions for the search. The queue rule and the analysis conditions (average number of people, high or medium for the level of detection) can be selected in combination. For example, when you select the checkbox where 'Queue 1' and 'Average' meet, the average number of people in the 'Queue 1' Queue is searched.

When you select the checkbox where 'Queue 1' and 'High' meet, the total time for the number of people corresponding to 'High' for the level of detection queuing in 'Queue 1' is searched. You can also select both 'Average' and 'High' that meet with 'Queue 1' for searching.

The rule can be set in [Statistics]>[Queue management]>[Setup].

#### Search queue data

1. Select the date you wish to search in [Date] of [Search].
2. Select the queue you wish to search and the analysis option in [Rule]. For example, if you wish to search the average number of people queuing in 'Queue 1' and the total time for the number of people corresponding to 'High' for the level of detection queuing in 'Queue 1', select the checkbox where 'Queue 1' and 'Average' meet and the checkbox where 'Queue 1' and 'High' meet.
3. Click the [Search] button. The search results will be displayed in [Results].

## Results

If you search queue data, the results will be shown in a graph and table.

If you search 'one recent day', data by hour from 00:00 to 24:00 on the current day will be shown. If you search 'one recent week', data by date from the 7 days immediately prior to the current day will be shown. If you search 'one recent month', data by date for the 30 days immediately prior to the current day will be shown.

If you select 'Period' and designate a specific day, month, and year, data by hour from 00:00 to 24:00 for the designated date and data by date for the designated month and year will be shown.

Queue data is displayed separately into 'Queue name-Average', 'Queue name-High', and 'Queue name-Medium' in the combination of the queue name and the analysis method (average number of people, high level of queuing, medium level of queuing). If

you select an option from a graph, only the relevant graph will be shown in Cyan. In addition, if you place the mouse on top of a graph, a balloon showing the data at the selected time in an exact numerical value will appear.

**i Note**

- Searched data refreshes every 15 minutes. The search results may differ from the real time results shown on the [\[Setting\]](#) page.

**Download**

When you click the [\[Download\]](#) button after searching, you can download the search results. The search results can be downloaded in .txt file formats, and the downloaded file will be saved in the browser's default save path. Up to 64 characters, including alphabetic characters and numbers, can be entered for the file name.



## Setup

Queue management is a function used to monitor the average number of people staying in a specified area and the total time of stay through an analysis of camera images. Set the queue rule you wish to analyze and the detailed items for improving the analysis accuracy in the 'Setup' page of queue management. When you complete the setting, click the [Apply] button at the bottom of the page.

### Setup

#### Enable queue management

To use the queue management function, select [Enable queue management].

### Rule

Set the queue rule for which you wish to analyze the number of queuing people or the queuing time. Up to 3 queue rules can be set.

#### Set queue management rule

To set the queue management rule, put a check mark in the checkbox in front of the [No.] column. When the queue management rule is displayed on the image screen, adjust the size and shape of the queue management area by dragging the corner of the area with the mouse. Enter the name of area in the [Name] field. Up to 15 characters, including alphabetic characters and numbers, can be entered for the rule name. The entered rule name is shown in [Statistics]>[Queue management]>[Search].

#### Activate and deactivate the queue management analysis for each rule

To activate the queue management analysis, select the check box in front of the relevant [No.] column.  
To deactivate the queue management analysis, deselect the check box in front of the relevant [No.] column. The queue management analysis setting for each rule remains intact, meaning if you select the check box again, the queue management analysis function will be activated in the same setting.

### Queue events

Set the conditions to create a queue event.  
A different queue event can be set for each queue set in [Rule].

#### Level of detection

The level of detection (queue level) displays the number of people staying in the set rule. An alarm is generated if the current level is higher than the target level of detection. The level of detection is classified into 'High' and 'Medium', according to the number of people in a given queue rule. When [Maximum] and [High] are set for the number of people, the 'Medium' value will be set automatically.

'High' for the level of detection refers to the status in which the number of people exceeding the 'High' value and less than the 'Maximum' value is detected. 'Medium' for the level of detection refers to the status in which the number of people exceeding the 'Medium' value and less than the 'High' value is detected.

For example, if 20 is set for the [Maximum] value and 18 is set for the [High] value, 9 will automatically be set for the 'Medium' value. If the number of people queuing in the relevant queue area is over 18 and less than 20, the level of detection will be 'High'. If

the number of people queuing in the relevant queue area is over 9 and less than 18, the level of detection will be 'Medium'.

### Minimum duration

The minimum queuing time for creating a queue event by the level of detection can be set. A queue event is created when the number of people corresponding to 'High' of [Level of detection] queues is longer than the time entered on [High] of [Minimum duration].

In other words, when '18' is set for 'High' of [Level of detection] and '60 seconds' is set for 'High of [Minimum duration], a queue event is created if 18 or more people are queuing in the queue area for 60 seconds or longer.

---

## Report

### Enable

To receive queue data periodically through e-mail and FTP, select [Enable]. Detailed settings for FTP and e-mail can be done from [Event]>[FTP/E-mail].

### Schedule

To receive queue data at the same time every day, select [Daily] and choose a time.

To receive queue data on the same weekday and time every week, select [Weekly] and select a weekday and a time.

### File name

Enter the file name for sending queue data through an FTP server or e-mail and select the file format. Up to 64 characters, including alphabetic characters and numbers, can be entered for the file name.

---

## Event action settings

### FTP

To save an image on an FTP server when a queue management event is created, select [Enable]. Detailed settings for FTP can be done from [Event]>[FTP/E-mail].

### E-mail

To send an image by e-mail when a queue management event is created, select [Enable]. Detailed settings for e-mail can be done from [Event]>[FTP/E-mail].

### Alarm output

It is possible to set the alarm output number for a specific alarm when a queue management event is created. After selecting an alarm output number, select [Off] if you do not wish to use the alarm. If you wish to use the alarm, select the output time. You can set the alarm to sound continuously until turned off by the user by selecting [Always] or set the alarm for 5, 10 or 15 seconds.

Depending on the alarm output setup, [Alarm output] options may look different. If there is no alarm output, [Alarm output] options are not displayed. If there is more than one alarm output, they are displayed as [Alarm output 1], [Alarm output 2], and so on. Select [Event]>[Alarm I/O] to set the alarm I/O.

## Delete all data

To delete all queue analysis data, click [Delete all data].

### **i** Note

- In the following cases, it is recommended that you reset the rules to match the changed video screen and click [Delete all data] to delete the old data used for the queue management search.
  - If you have changed the settings in [Video & Audio] > [Video setup] > [Video rotation]
  - If you change the settings in [Video & Audio] > [Camera setup] > [Special] > [DIS]

### **i** Note

The queue management function aims at supplying statistical data, not data with real time accuracy, and it may include moving objects or animals as the total number of measured units.

After installing the camera, it may continue to malfunction until it is stabilized. The time for stabilization may take up to 50 to 60 minutes.

If you use the queue function in an environment with short waiting time, it can generate a lot of events.

In any of the following cases, errors in the measured data are likely to increase:

If installed in a space with no sufficient visions

Night time or low brightness (Figure 1)

In an environment with a sudden change in light, or in case of exposure to strong light, such as direct sunlight, sunset, sunrise, direct lighting, etc. (Figure 2)

If there is consistent movement at the fixed location such as near the door (Figure 3)

If many people move in a group

If moving object is close to the set rule,

If the rule is set at the outer edge of image for a fisheye camera (Figure 4)

A camera to operate queue management requires that the lens to be installed on the ground in a direct drop. (Figure 5)

Figure 1

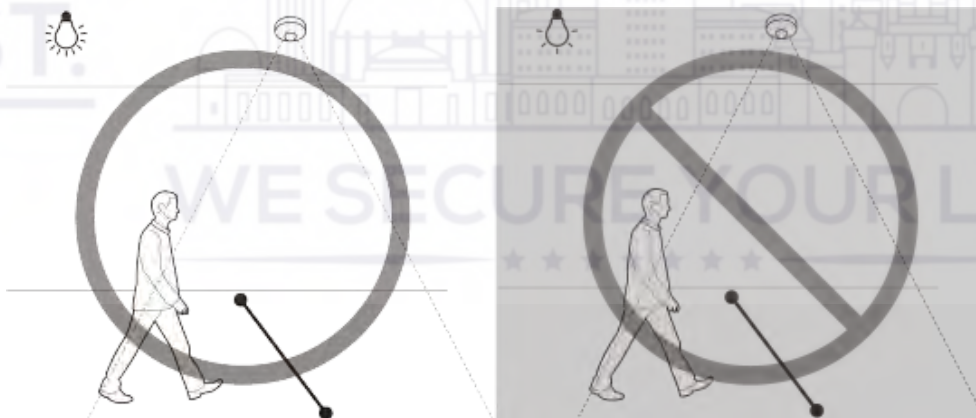

Figure 2

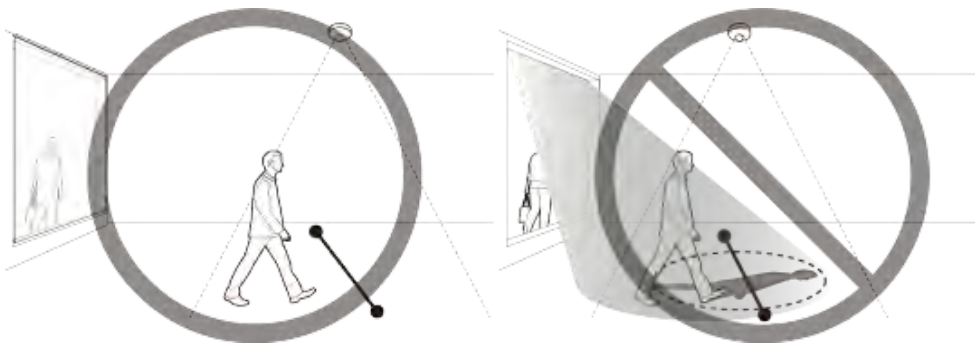

Figure 3

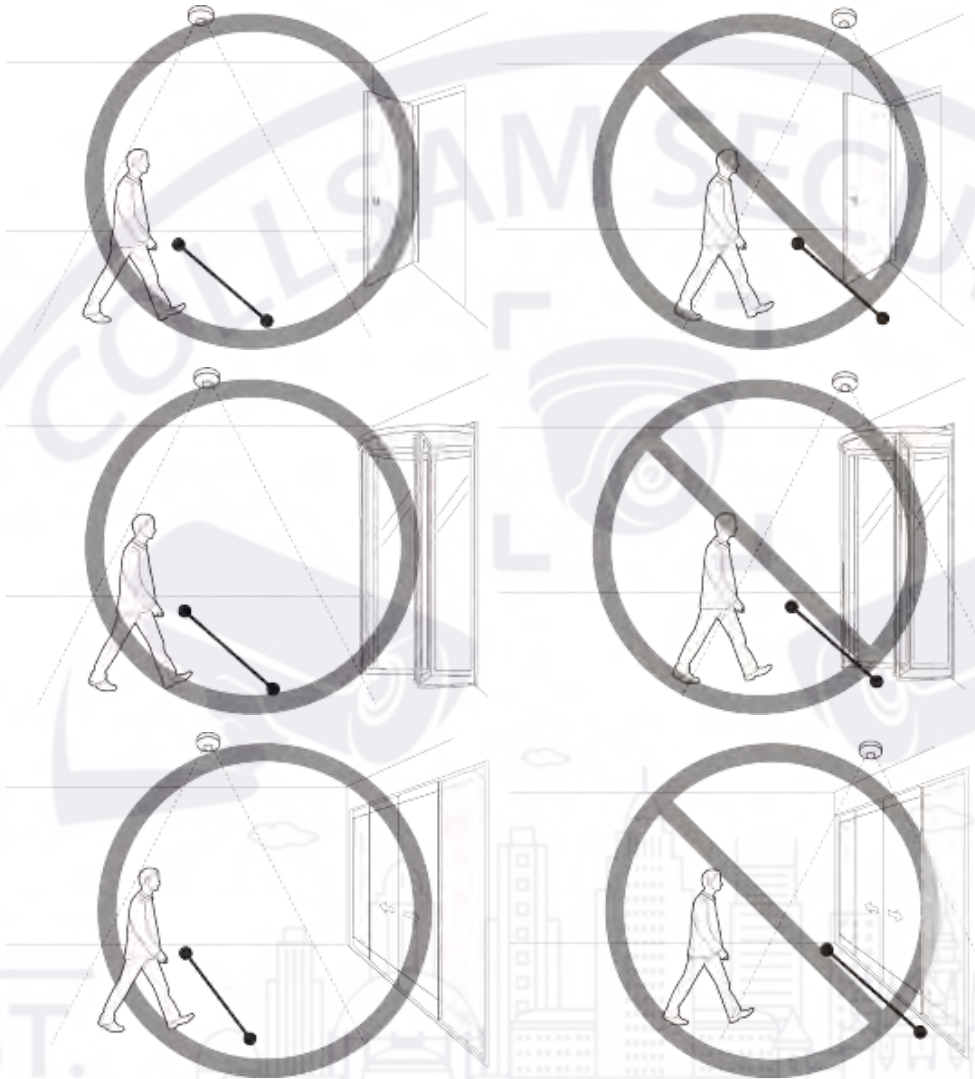

Figure 4

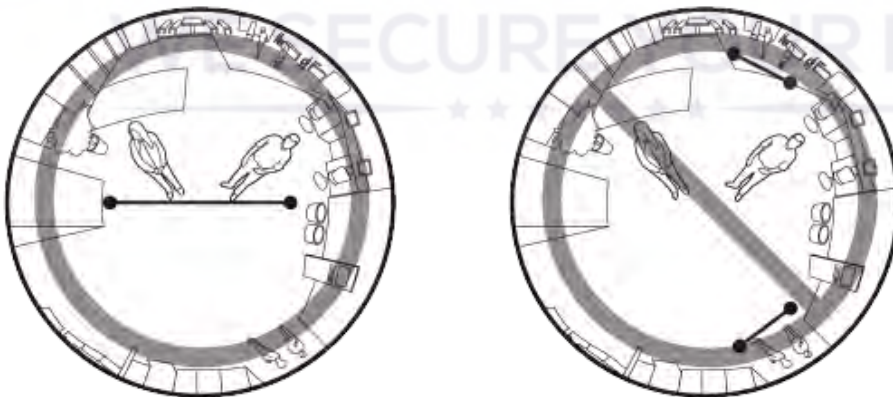
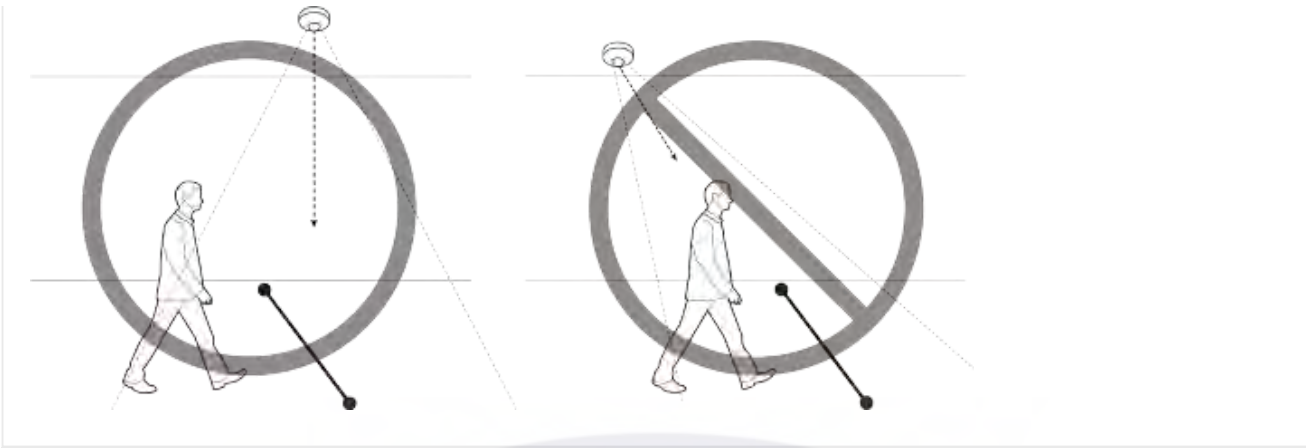

Figure 5



COLLSAM SECURITY



EST.

1998

WE SECURE YOUR LIFE



## Search

Heatmap shows the frequency of motion on the screen in color. You can search heatmap data and confirm results from 'heatmap search'.

### **i** Note

- In order to use the heatmap search function, you need to activate it by selecting [Enable heatmap] from [Statistics]> [Heatmap]>[Setup].

### Heatmap

Heatmap information based on the frequency of motions in the current image will appear on the screen. For the frequency of motion by color to be shown on the screen, refer to the color in [Index].

### Index

The Index color bar indicates the frequency of motions. If the frequency of motions is low, it is displayed in blue, and in red if the frequency of motions is high.

### Search

When you select [Recent], you can search by recent day, week or month. When you select [Period], you can specify a daily, monthly, or yearly period for searching. The heatmap search results will be displayed on the screen immediately.

### Searching heatmap and viewing results

1. Select the date you wish to search from [Date] in [Search].
2. Click the [Search] button.
3. The search results will be displayed in [Results].

### Results

If you have searched heatmap data, the results will be displayed. Heatmap information for the period you have searched, with the image at the time of searching as the background, will be displayed.

### **i** Note

- Searched data refreshes every 15 minutes. The search results may differ from the real time results shown on the [Setup] page.

### Download

When you click the [Download] button after searching, you can download the search results as an image file. The search results can be downloaded in .png format; the downloaded file will be saved in the browser's default save path. Up to 64 characters, including letters and numbers, can be entered for the file name.

## Setup

Heatmap shows the frequency of motion on the screen in color. In 'heatmap setup', you can set the color of the background image and an area to be excluded when heatmap data is collected. When you complete the setting, click the [Apply] button at the bottom of the page.

### **i** Note

- The camera or human height set in [Statistics]>[People counting]>[Setup] > [Calibration] applies equally to the heatmap functions.
- The heatmap function aims at supplying statistical data, not data with real time accuracy, and it may include moving objects or animals in the total measured number of units.
- After installing the camera, it may continue to malfunction until it is stabilized. The time for stabilization may take up to 50 to 60 minutes.
- In any of the following cases, errors in the measured data are likely to increase:
  - If installed in a space with no sufficient visions
  - Night time or low brightness
  - In an environment with a sudden change in light, or in case of exposure to strong light, such as direct sunlight, sunset, sunrise, direct lighting, etc.
  - If there is consistent movement at the fixed location such as near the door
  - If many people move in a group

### Setup

#### Enable heatmap

To use the heatmap function, select [Enable heatmap].

### Configuration

Set the color of the heatmap background image.

#### Background color

Select the color of the background image that shows heatmap data. When [Color] is selected, the background image will be displayed in color, and when [B/W] is selected, the background image will be displayed in black and white.

### Exclude area

Motion in an area designated by the user will not be collected as heatmap data.

#### Setting an exclude area

When you select the 4 corners of an image with the mouse, the area is set as the exclude area, and the color of the number buttons in [Area] changes. Up to 4 exclude areas can be set.

#### Changing an exclude area

You can change the size of an exclude area by clicking a corner or a line of the exclude area and moving it. To move an exclude area, click and drag the relevant area with the mouse.

#### Deleting an exclude area

To delete an exclude area, click the right mouse button at the relevant area on the screen and click the [OK] button on the delete confirm window.

## Area

When you click a number button in [Area], the relevant area will be selected in the image. The edge of the selected area will appear with a thick white line.

---

## Report

### Enable

To receive heatmap data periodically through e-mail and FTP, select [Enable]. Detailed settings for FTP and e-mail can be done from [Event]>[FTP/E-mail].

### Schedule

To receive heatmap data at the same time every day, select [Daily] and choose a time.  
To receive heatmap data on the same weekday and time every week, select [Weekly] and select a weekday and a time.

### File name

Enter the file name for sending heatmap data through an FTP server or e-mail and select the file format. Up to 64 characters, including letters and numbers, can be entered for the file name.

---

## Delete all data

To delete all heatmap statistics data, click [Delete all data].

### Note

- In the following cases, it is recommended that you reset the rule to match the changed video screen and click [Delete all data] to delete the old data used for searching the heat map.
  - If you have changed the settings in [Video & Audio] > [Video setup] > [Video rotation]
  - If you change the settings in [Video & Audio] > [Camera setup] > [Special] > [DIS]

EST.

1998

WE SECURE YOUR LIFE



## Data server setup

When a Retail Insight server is registered, camera's data (People counting, Queue management, and Heatmap data) is transferred to the registered server. On the [Data server setup] page, Retail Insight server information can be entered and registered. Click the [Apply] button below after entering the necessary information.

### Data server setup

#### Enable data server

To transfer camera's data to the Retail Insight server, select [Enable data server].

### Login

Server information can be entered to register the Retail Insight server.

#### IP

Enter the IP address of the Retail Insight server.

#### Note

- Next to the [IP] field, a message indicating the status of connection to the server is displayed.
  - Connecting: Displayed when attempting to connect to the Retail Insight server. When the [Apply] button at the bottom of the page or [Enable data server] is selected, connection to the server is attempted.
  - Success: Displayed when connected to the Retail Insight server.
  - Failed: Displayed when failed to connect to the Retail Insight server. If this message persists, make sure that the Retail Insight server information on the [Data server setup] page is correct.

#### Port

Enter the port value of the Retail Insight server.

The port value can be 80 or anywhere between 1024 to 65535.

#### ID

Enter the ID of the account for logging in to the Retail Insight server.

ID can contain up to 8 letters, but does not allow special characters: #%&+=\:<>""

#### Password

Enter the password of the account for logging in to the Retail Insight server.

Password can be 8 to 20 letters, but does not allow special characters: #%&+=\:<>""

### Store name

Enter your store name.

The store name is used by the Retail Insight server to distinguish your camera.

## Product information

Check the model name and serial number of the product and set the device name, location, description and language. When you complete the setting, click the [Apply] button at the bottom of the page.

### Product information

#### Model

The model name of the product you are currently using is displayed. Changes cannot be made to the model name.

#### Serial number

The serial number of the product you are currently using is displayed. Changes cannot be made to the serial number.

#### Device name

Enter the device name of the product you are currently using. If you have installed a number of cameras, a different device name for each camera is recommended.

#### Location

Enter the installation location of the product you are currently using. If you have installed a number of cameras, a different location name is recommended to distinguish between them.

#### Description

Enter the description of the product you are currently using. You can enter other necessary information, including the installation date and location where the screen is showing.

#### Memo

Enter the description of the product you are currently using. Enter other necessary information that were not entered on the description section.

#### Language

Select the language of the product you are currently using. When you select a language and click Apply, all UI will be changed to the relevant language.

#### Open source license

We provide open source licenses used by this product. Click the [View] button to see the information of the open source licenses used by this product and full license texts.

**i Note**

- Korean characters cannot be entered - only English uppercase and lowercase letters, numbers and special characters can be entered. Up to 8 characters can be entered.
- For 'Location', 'Description', and 'Memo', you can only use alphanumeric characters, space, and the following special characters: ~!@\$^()\_-{|};,./? You can enter up to 32 characters.

COLLSAM SECURITY



EST.

1998

WE SECURE YOUR LIFE



## Upgrade / Restart

You can upgrade the software of the product you are currently using, perform a factory default, back up or restore the configuration, or restart.

### Upgrade

Software can be upgraded as new firmware versions are released.

#### Software

The software version of the product you are using is displayed. Changes cannot be made to the software version.

You can view the software details, including the ISP version applied to the software and SUNAPI version, by clicking the [Info] button.

#### Software upgrade

You can upgrade the software of the product you are using. To upgrade the software, click the [...] button. Select an upgrade file and click the [Open] button. When you click the [Upgrade] button, upgrading will begin. You can view the upgrading progress in %. When upgrading has ended, the camera will reboot and the connection will be terminated automatically. You will need to reconnect to the web viewer.

#### **i** Note

- Upgrade can take up to 10 minutes. Do not terminate the program while upgrading is in progress. Doing so may result in the program failing to upgrade properly.
- For the web viewer to work properly, you need to delete all the browser caches before connecting again after the software upgrade.
- You can download the latest software version from Hanwha Techwin's website: <http://www.hanwha-security.com>

### Factory default

Resets the system configuration to what it was at the time of product purchase. When you click the [Reset] button and then click the [OK] button in the confirm window, the factory default reset will be carried out. (Logs won't be reset though.)

If you wish to reset the system configuration (except for the network configuration and installed open platform configuration) to factory default, select [Except network parameter & open platform]. When a factory default is carried out, the connection with the camera will be terminated. When you reconnect to the web viewer for the first time, you will need to enter the password again.

## Configuration backup & restore

You can backup and save the current camera setup or restore a desired configuration. You can create a number of backup files for desired configurations, or restore and use a desired configuration according to the purpose or environment when using the product.

### Backup

When you click the [Backup] button, a backup file of 'model name Config.bin' will be created.

### Restore

When you click the [Restore] button, a window where you can select a backup file to restore will appear. When you select a backup file and press the [Open] button, the configuration will be restored based on the relevant backup file.

#### **i** Note

- When you restore the configuration, the connection with the camera will be terminated automatically and you will need to reconnect to the web viewer.
- If you use an imported backup file for a different model than the product you are currently using, the product may malfunction. Do not use a backup file for a different model or change the configuration manually.

### Restart

Restart the camera system. Click the [Restart] button, and when the confirm window appears, click the [OK] button. The camera will restart and the web viewer window will close. You will need to reconnect to the web viewer.

EST.



1998

## Log

You can check camera-related logs. You can check information including camera access, system changes and events which have occurred, and backup log information for each log type.

### **i** Note

The maximum number of logs that can be displayed on one page is 15.

Logs can be checked in order of most recent log first.

Up to 1,000 logs can be saved.

When the number of logs that are saved exceeds 1,000, a new log is saved after deleting the oldest log.

### Access log

You can check login and logout information for each access account.

#### Log type

You can check accounts which have accessed the camera, login and logout date, and time information. When you select All, you can check login and logout, date & time, and detailed information for all access IDs.

#### Export

You can backup the selected log type as a text file. To backup the access log, click the [Export] button. The log file information is displayed as camera model name\_log type\_backup date, and time.

### System log

You can check date & time and detailed information for system changes.

#### Log type

This allows you to check camera system setup change information, along with the date and time. When you select All, you can check date & time and detailed information for all system changes.

#### Export

You can backup the selected log type as a text file. To backup the system log, click the [Export] button. The log file information is displayed as camera model name\_log type\_backup date, and time.

### Event log

You can check the date & time and detailed information for an event which has occurred in the system.

### Log type

You can check occurrence date & time and detailed information for a selected event. When you select All, you can check the date & time and detailed information for all events occurring in the system.

### Export

You can backup the selected log type as a text file. To backup the event log, click the [Export] button. The log file information is displayed as camera model name\_log type\_backup date, and time.



## Open platform

When you install an additional application on the camera, you can use the functions of the installed application in addition to existing functions.

## Open platform

### Installing an open platform

1. Click the [...] button, select an application and then click the [Open] button.
2. Click the [Install] button. When installation of the application is complete, a message saying 'Installed' is displayed and information about the installed application is displayed in the list.

### No.

A number is assigned in the installation order of application.

### Application name

The application name, installed date and version are displayed.

- Uninstall: Deletes an installed application.
- Go App: Moves to the screen provided by each application.

### Status

Displays the running status of an application.

When an application is running, 'Running' is displayed, and when an application is stopped, 'Stopped' is displayed.

- Start: Executes the installed application.
- Stop: Stops a running application.
- Health: The resource usage rate, thread count and running time of currently-running applications are displayed. This is activated only when at least one application is running.

### Setup

Sets the execution priority and auto start of applications. Set to your preference and click the [Apply] button.

- Priority: Sets the priority among applications that are running. If the resource usage of the whole camera (including the main task of the camera and applications) becomes too high, some applications that are running will be forcibly closed. Applications set as 'low priority' by the user are closed first.
- Auto start: When [Enable] is selected, an application will be executed automatically when the camera is powered on and the main task is executed.

### Application manager

The resource usage rate of applications currently running in the camera is displayed.

- Application name: The application name is displayed.

- Memory usage (%): The memory usage rate of each application is displayed.
- CPU usage (%): The CPU usage rate of each application is displayed.
- Thread count: The number of threads created by each application is displayed.
- Duration: The total operating time of each application is displayed.
- Action: The action status of each application is displayed. To stop the application, click [Kill App].
- Total usage: The total resource usage rate (including the main task of the camera and applications) currently used in the camera is displayed.

**i Note**

- For questions regarding the installation and usage of applications, contact the developers' website of Hanwha Techwin ([https://step.hanwha-security.com/kor\\_EN/Default.aspx](https://step.hanwha-security.com/kor_EN/Default.aspx) ([https://step.hanwha-security.com/kor\\_EN/Default.aspx](https://step.hanwha-security.com/kor_EN/Default.aspx))).

COLLSAM SECURITY



EST.

1998

WE SECURE YOUR LIFE



COLLSAM SECURITY



EST.

1998

**Head Office**

6, Pangyo-ro 319 beon-gil, Bundang-gu, Seongnam-si,  
Gyeonggi-do, 463-400 Rep. of KOREA  
Tel: +82.70.7147.8753 Fax: +82.31.8018.3740  
[www.hanwha-security.com](http://www.hanwha-security.com)

**Hanwha Techwin America**

500 Frank W. Burr Blvd. Suite 43 Teaneck, NJ 07666  
Toll Free +1.877.213.1222 Direct +1.201.325.6920  
Fax +1.201.373.0124  
[www.hanwha-security.com](http://www.hanwha-security.com)

**Hanwha Techwin Europe**

Heriot House, Heriot Road, Chertsey, Surrey, KT16 9DT, United Kingdom  
Tel +44.1372.235663 Fax +44.1932.57.8101  
[www.hanwha-security.eu](http://www.hanwha-security.eu)

WE SECURE YOUR LIFE

