

DS-2CD6D54FWD-IZHS

20 MP H.265+ PanoVu EXIR Flexible Network Camera Series



Hikvision's DS-2CD6D54FWD-IZHS 20 MP H.265+ EXIR PanoVu Flexible Outdoor Network Camera features 1/2.7" progressive scan CMOS sensors and four lenses. Each lens supports 5 MP at 24 fps. Compression up to H.265+ saves bandwidth and storage space. EXIR technology (-I) extends the IR range to 98 feet (30 meters).



- 1/2.7" Progressive Scan CMOS
- 2560 x 1920 @ 24 fps
- 4 x 2560 x 1920 @ 24 fps (20 MP Total)
- FOV: Horizontal 30° to 101°, Vertical 22.4° to 73°, Diagonal: 37° to 137°
- H.265+, H.265, H.264+, H.264
- True Day/Night
- 120 dB WDR
- 6 Behavior Analyses, 4 Exception Detections, and Face Detection
- 98 ft (30 m) IR Range
- IP67, IK10
- 4 x 3-Axis Individual Camera Gimbals

-Z: Zoom lens

-I: IR

-H: Heater (activates at -40° C)

-S: 1 audio input (line in), 1 audio output, 2 alarm inputs, 2 alarm outputs, 1 RS-485 interface

Specifications

| DS-2CD6D54FWD-x | | |
|-----------------------------|--|---|
| Camera | | |
| Image Sensor | 4 x 5 MP 1/2.7" progressive scan CMOS | |
| Minimum Illumination | Color: 0.006 lux @ (f/1.2, AGC on), 0.010 lux @ (f/1.6, AGC on) B/W: 0.002 lux @ (f/1.2, AGC on); 0.003 lux @ (f/1.6, AGC on) 0 lux with IR on | |
| Shutter Speed | 1/25 s–1/100,000 s | |
| Auto-Iris | No | |
| Day/Night | IR cut filter | |
| Digital Noise Reduction | 3D DNR | |
| WDR | 120 dB | |
| 3-Axis Adjustment | Four flexible lenses in one track, slide range: -180° to 180°, tilt: 0° to 135°, rotate: 0° to 355° | |
| Lens | | |
| Focal Length | 2.8 mm to 12 mm | |
| Aperture | f/1.6 | |
| FOV | Horizontal field of view: 30° to 101° Vertical field of view: 22.4° to 73° Diagonal field of view: 37° to 137° | |
| Lens Mount | Ø14 | |
| IR | | |
| IR Range | 33 ft to 98 ft (10 m to 30 m) | |
| Wavelength | 850 nm | |
| Compression Standard | | |
| Video Compression | Main stream: H.265+/H.265/H.264+/H.264 Sub stream: H.265/H.264/MJPEG Third stream: H.265/H.264 | |
| H.264 Type | Baseline profile/main profile/high profile | |
| H.264+ | Yes | |
| H.265 Type | Main profile | |
| H.265+ | Yes | |
| Video Bit Rate | 32 Kbps to 16 Mbps | |
| Audio Compression | G.711/G.722.1/G.726/MP2L2/PCM (-S) | |
| Audio Bit Rate | 64 Kbps (G.711)/16 Kbps (G.722.1)/16 Kbps (G.726)/32–192 Kbps (MP2L2) (-S) | |
| Smart Features | | |
| Behavior Analysis | Any single channel, or channels | Line crossing detection, intrusion detection, region entrance detection, region exiting detection, unattended baggage detection, object removal detection |
| Exception Detection | 1+3, or 2+4 | Audio exception detection (-S), scene change detection, defocus detection |
| Face Detection | 1+3, or 2+4 | Yes |
| Region of Interest | Supports 4 fixed regions for each stream | |
| Image | | |
| Maximum Resolution | 2560 x 1920 | |
| Original Image | Main Stream | 24 fps (2560 x 1920, 2048 x 1536, 1920 x 1080, 1280 x 720) |
| | Sub-Stream | 24 fps (704 x 480, 640 x 480) |
| | Third Stream | 8 fps (1920 x 1080, 1280 x 720, 704 x 576, 640 x 480) |
| Full FOV | Total | 10240 x 1920 |
| Resolution | Per Sensor | 2560 x 1920 |
| Image Enhancement | BLC, 3D DNR, EIS | |
| Image Setting | Rotate mode, saturation, brightness, contrast, sharpness, and white balance are adjustable by client software or Web browser | |
| SVC | Supported | |
| Day/Night Switch | Day/night/auto/schedule/triggered by alarm in (-S) | |
| Picture Overlay | Logo picture can be overlaid on video with 128 x 128 24-bit bmp format | |
| Network | | |
| Network Storage | Supports microSD/SDHC/SDXC card (128 GB), local storage and NAS (NFS, SMB/CIFS), ANR | |
| Alarm Trigger | Motion detection, video tampering alarm, network disconnected, IP address conflict, illegal login, HDD full, HDD error | |
| Protocols | TCP/IP, ICMP, HTTP, HTTPS, FTP, DHCP, DNS, DDNS, RTP, RTSP, RTCP, PPPoE, NTP, UPnP, SMTP, SNMP, IGMP, 802.1x, QoS, IPv6, UDP | |
| General Functions | One-key reset, anti-flicker, mirror, heartbeat, password protection, privacy mask, watermark, IP address filter | |
| API | ONVIF (PROFILE S, PROFILE G), ISAPI | |
| Simultaneous Live Views | Up to 20 channels | |
| User/Host | Up to 32 users 3 levels: Administrator, Operator, and User | |
| Client | iVMS-4200 | |
| Web Browser | IE8+, Chrome 31–44, Firefox 30.0–51 | |







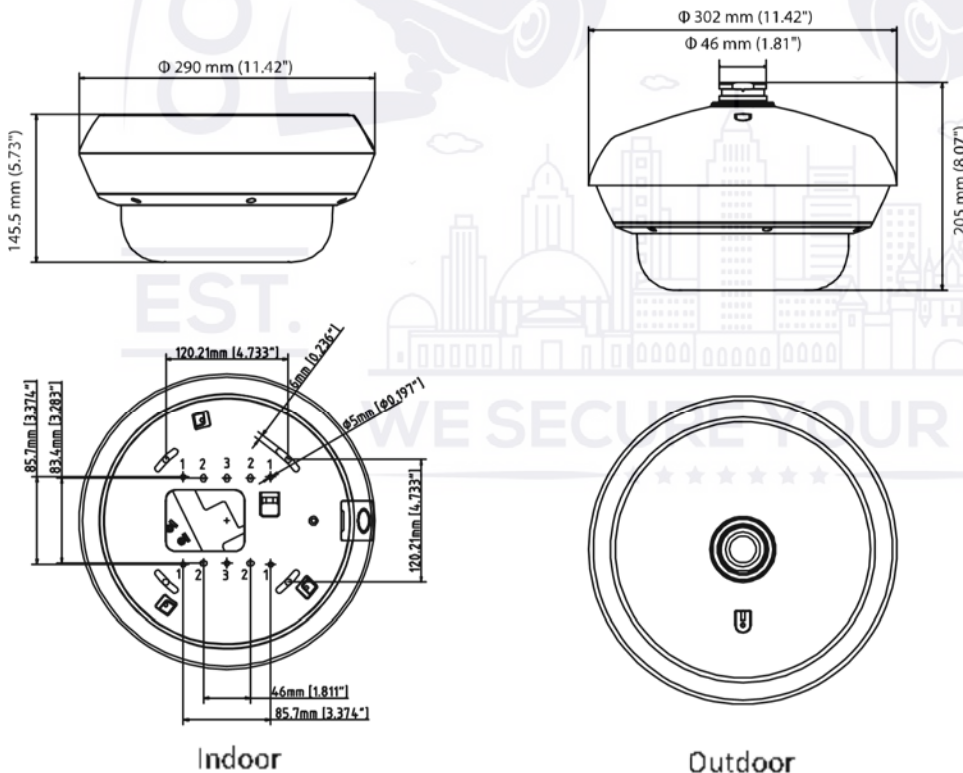

Specifications (continued)

| Interface | |
|-----------------------------|---|
| Audio (-S) | 1-ch 3.5 mm input (line in), 1-ch 3.5 mm output, dual-track, stereo |
| Communication Interface | 1 RJ-45 10M/100M/1000M Ethernet port 1 RS-485 interface (-S) |
| Alarm (-S) | 2 inputs, 2 outputs (up to 24 VDC, 1A, or 110 VAC, 500 mA) |
| On-Board Storage | Built-in microSD/SDHC/SDXC slot, up to 128 GB |
| Reset Button | Yes |
| Audio (-S) | |
| Environment Noise Filtering | Supported |
| Audio Sampling Rate | 8 kHz/16 kHz/32 kHz/44.1 kHz/48 kHz |
| General | |
| NVR Compatibility | Fully compatible with Hikvision I Series NVRs, compatible with E Series up to H.264+ |
| Operating Conditions | -22° to 140° F (-30° to 60° C). -H: -40° to 140° F (-40° to 60° C) Humidity 95% or less (non-condensing) |
| Power | -Z 12 VDC ±25%, 12 W |
| | -IZHS 12 VDC ±25%, 28 W |
| | Hi-PoE 34 W (PoE injector included) |
| Protection Levels | IP67, IK10 |
| Material | Aluminum alloy, engineering plastics |
| Gimbals | 4 x 3-axis with 360° pan, 90° tilt, and 360° Z-axis |
| Dimensions | Camera: Ø290 mm × 145.5 mm (Ø11.42" × 5.73") |
| | Package: 453 mm × 393 mm × 385 mm (17.8" × 15.47" × 15.16") |
| Weight | Camera: Approximately 4.7 kg (10.3 lb) |
| | With package: Approximately 7.7 kg (16.8 lb) |

Dimensions



Accessories

| Not Included | | | | | |
|---|---|---|--|---|---|
|  |  |  |  |  |  |
| WMP-L Wall Mount | WMP-PV Wall Mount | JBPW-L Wall Mount | PMP Vertical Pole Mount | CMP Corner Mount | CPM-S Pendant Mount Small |
|  |  |  |  | | |
| RPM Roof Parapet Mount | PMP-JB Pole Mount | CPM-L Ceiling Pendant Mount Large | CPMPE Ceiling Pendant Mount Extension | | |
| Included | | | | | |
|  | | | | | |
| Pendant Cap | | | | | |

Box Contents (Subject to Change without Notice)

BNC Connector
 Machine Screws
 Microfiber Cloth
 Mounting Posts
 Pendant
 Plastic 3/4" Conduit Adapter
 Power Filter
 Power Pigtail with Screw Terminals
 Quick Start Guide x 2
 Screws
 Steel Washer
 Watertight Tape
 Wrench
 Watertight Cable Connector