



VDP Series Video Intercom Kit Quick Installation Guide

V1.0.1



Dahua Technology Co., Ltd



Foreword

General

This manual offers reference material and general information about the basic operation, maintenance, and troubleshooting for a Dahua Video Intercom device. Read, follow, and retain the following safety instructions. Heed all warning on the unit and in the operating instructions before operating the unit. Keep this guide for future reference.

Safety Instructions

The following categorized signal words with defined meaning might appear in the Guide.

Signal Words	Meaning
 WARNING	Indicates a medium or low potential hazard which, if not avoided, could result in slight or moderate injury.
 CAUTION	Indicates a potential risk which, if not avoided, could result in property damage, data loss, lower performance, or unpredictable result.
 NOTE	Provides additional information as the emphasis and supplement to the text.

Revision History

No.	Version	Revision Content	Release Time
1	V1.0.0	First Release.	April 2020
2	V1.0.1	Revised for North America	May 2020

Privacy Protection Notice

As the device user or data controller, you may collect personal data such as face images, fingerprints, license plate number, email address, phone number, GPS location and other sensitive or private information. You must ensure that your organization is in compliance with local privacy protection laws and regulations to protect the legitimate rights and interests of other people by implementing measures include but not limited to: providing clear and visible identification to inform data subject the existence of surveillance area and providing related contact

About the Guide

- This user guide has been compiled with great care and the information it contains has been thoroughly reviewed and verified.
- The text was complete and correct at the time of printing. This guide may be periodically updated to reflect changes to the product or to correct previous information and the content of this guide can change without notice.
- If you encounter an error or have any questions regarding the contents of this guide, contact customer service for the latest documentation and supplementary information.
- Dahua accepts no liability for damage resulting directly or indirectly from faults, incompleteness, or discrepancies between this guide and the product described. Dahua is not liable for any loss caused by installation, operation, or maintenance inconsistent with the information in this guide.
- All the designs and software are subject to change without prior written notice. The product updates may cause some differences between the actual product and the Guide. Please contact the customer service for the latest program and supplementary documentation.
- Video loss is inherent to all digital surveillance and recording devices; therefore Dahua cannot be held liable for any damage that results from missing video information. To minimize the occurrence of lost digital information, Dahua recommends multiple, redundant recording systems, and adoption of backup procedure for all data.
- All trademarks, registered trademarks and the company names in the Guide are the properties of their respective owners.
- Please visit our website, contact the supplier or customer service if there is any problem occurred when using the device.
- Contact the supplier or customer service if you encounter any issue while using this unit.

FCC Information

This device complies with part 15 of the FCC Rules. Operation is subject to the following two conditions:

- This device may not cause harmful interference;
- This device must accept any interference received, including interference that may cause undesired operation.

FCC compliance :

This equipment has been tested and found to comply with the limits for a digital device, pursuant to part 15 of the FCC Rules. These limits are designed to provide reasonable protection against harmful interference. This equipment generates uses and can radiate radio frequency energy and, if not installed and used in accordance with the instruction manual, may cause harmful interference to radio communication. However, there is no guarantee that interference will not occur in a particular installation. If this equipment does cause harmful interference to radio or television reception, which can be determined by turning the equipment off and on, the user is encouraged to try to correct the interference by one or more of the following measures:

- Reorient or relocate the receiving antenna.
- Increase the separation between the equipment and receiver.
- Connect the equipment into an outlet on a circuit different from that to which the receiver is connected.
- Consult the dealer or an experienced radio/TV technician for help.

Legal Notices

Copyright

This user guide is ©2020, Dahua Technology Company, LTD.

This user guide is the intellectual property of Dahua Technology Company, LTD and is protected by copyright. All rights reserved.

Trademarks

All hardware and software product names used in this document are likely to be registered trademarks and must be treated accordingly.

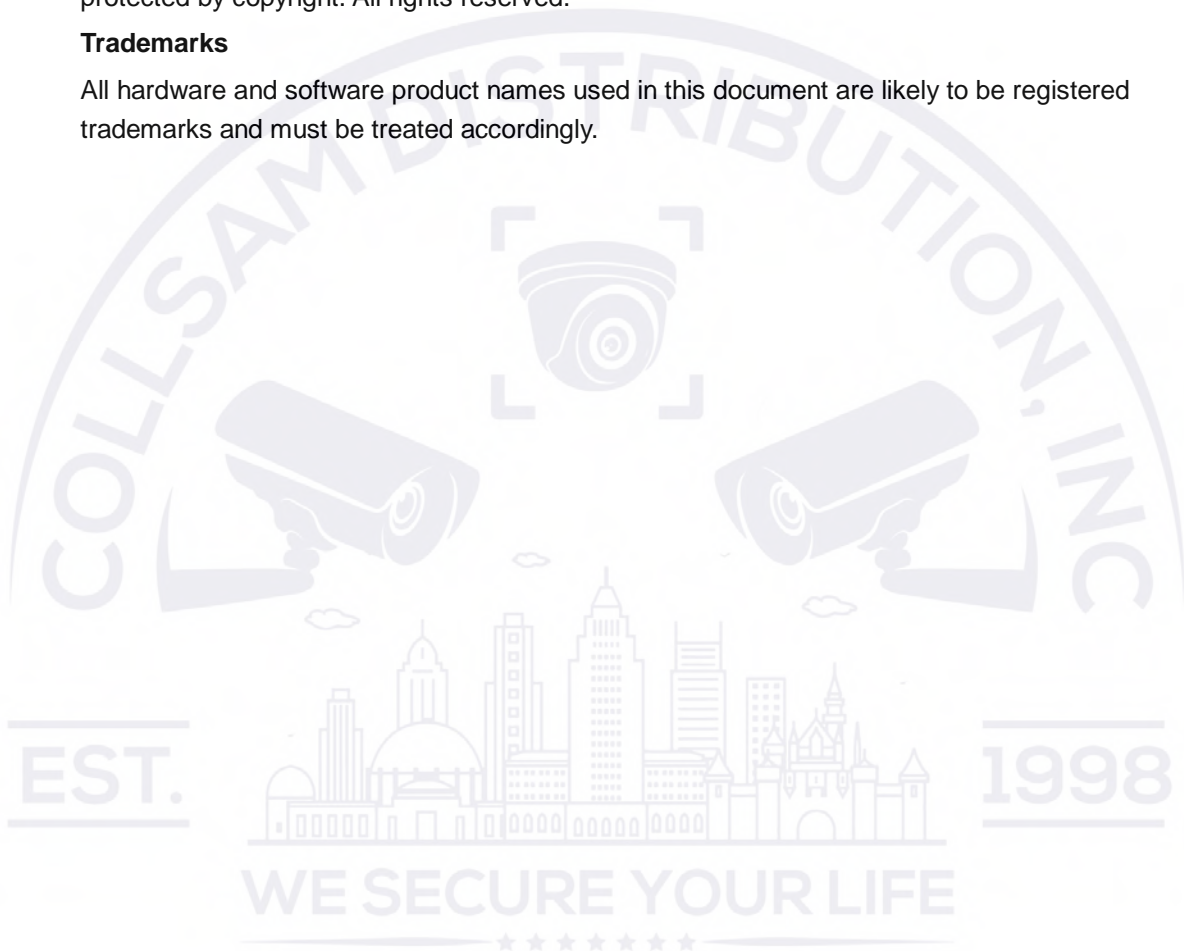

Important Safeguards and Warnings

This chapter describes the contents covering proper handling of the device, hazard prevention, and prevention of property damage. Read these contents carefully before using the device, comply with them when using, and keep it well for future reference.

Installation and Maintenance Professionals Requirements

- All installation and maintenance professionals must have adequate qualifications or experiences to install and maintain CCTV systems and electric apparatus, and to work above the ground. The professionals must have the following knowledge and operation skills:
- Basic knowledge and installation of CCTV systems.
- Basic knowledge and operation skills of low voltage wiring and low voltage electronic circuit wire connection.
- Basic knowledge and operation skills of electric apparatus installation and maintenance in hazardous sites.

Power Requirements

- Install the unit in accordance with the manufacturer's instructions and in accordance with applicable local codes.
- All installation and operation must conform to your local electrical safety codes.
- Do not overload outlets and extension cords, which may cause fire or electrical shock.
- Do not place the camera near or in a place where the camera may contact overhead power lines, power circuits, or electrical lights.
- Ensure power conforms to SELV (Safety Extra Low Voltage) and that the limited power source is rated 16 VAC to 24 VAC, 12 VDC, or 24 VDC as specified in IEC60950-1. (Power supply requirement is subject to the device label).
- All input/output ports are SELV circuits. Ensure that SELV circuits are connected only to other SELV circuits.
- Ground the unit using the ground connection of the power supply to protect the unit from damage, especially in damp environments.
- Please install easy-to-use device for power off before installing wiring, which is for emergent power off when necessary.
- Protect the plug and power cord from foot traffic, being pinched, and its exit from the unit.
- Do not attempt to service the unit. Opening or removing covers may expose you to dangerous voltage or other hazards. Refer all servicing to qualified personnel.

- If the unit is damaged and requires service, unplug the unit from the main AC power supply and from the PoE supply and refer to qualified service personnel. Damage may include, but is not limited to:
 - The power supply cord or plug is damaged.
 - Liquid has spilled in or on the unit.
 - An object has fallen on the unit.
 - The unit has been dropped and the housing is damaged.
 - The unit displays a marked change in performance.
 - The unit does not operate in the expected manner when the user correctly follows the proper operating procedures.
- Ensure a service technician uses replacement parts specified by the manufacturer, or that have the same characteristics as the original parts. Unauthorized parts may cause fire, electrical shock, or other hazards. Dahua is not liable for any damage or harm caused by unauthorized modifications or repairs.
- Perform safety checks after completion of service or repairs to the unit.
- Use attachments and accessories only specified by the manufacturer. Any change or modification of the equipment, not expressly approved by Dahua, could void the warranty.
- Incorporate a readily accessible disconnect device in the building installation wiring for quick power disconnect to the camera.
- Dahua assumes no liability or responsibility for any fire or electrical shock caused by improper handling or installation.

Application Environment Requirements

- Please use the device within the allowed humidity (<95%RH) and altitude (<3000m).
- Transport, use, and store the unit within the specified temperature and humidity range.
- Do not place the unit in a wet, dusty, extremely hot or an extremely cold environment; and avoid environments with strong electromagnetic radiation or unstable lighting.
- Do not use the device in the corrosive environment such as high salt fog area (sea, beach and coastal area), acid gas environment and chemical plants.
- Do not use the device in applications with strong vibrations such as in boats and vehicles.
- Never push objects of any kind into this unit through openings as they may touch dangerous voltage points or cause a short circuit that may result in fire or electrical shock. Take care to not spill any liquid on the unit.
- If your installation environment is subjected to one of the conditions above, contact our sales staff to purchase cameras intended for the particular environment.
- Please don't install the device near the place with heat source, such as radiator, heater, stove or other heating equipment, which is to avoid fire.
- Do not aim the lens at an intense radiation source (such as the sun, a laser, and molten steel for example) to avoid damage to the thermal detector.
- Use the factory default package or material with equal quality to pack the device when transporting.

Operation and Maintenance Requirements

- Do not touch the heat dissipation component of the unit. This part of the unit is hot and may cause a burn.
- Do not open or dismantle the device; there are no components that a user can fix or replace. Opening the unit may cause water leakage or expose components to direct light. Contact the manufacturer or a qualified service representative to service the camera or to replace a component, including the desiccant.
- Dahua recommends the use of a thunder-proof device in concert with the unit.
- Do not touch the CCD or the CMOS optic sensor. Use a blower to clean dust or dirt on the lens surface. Use a dry cloth dampened with alcohol and gently wipe away any dust on the lens.
- Use a dry soft cloth to clean the unit's housing. If the unit is particularly dusty, use water to dilute a mild detergent, apply the diluted detergent to a soft cloth, then gently clean the device. Finally, use a dry cloth to wipe the unit dry. Do not use a volatile solvent like alcohol, benzene, or thinner; or use a strong detergent with abrasives, which may damage the surface coating or reduce the working performance of the unit.
- Do not touch or wipe a dome cover during installation, this cover is an optical device. Refer to the following methods clean the dome cover:
 - Stained with dirt: Use an oil-free soft brush or blower to gently remove the dirt.
 - Stained with grease or fingerprints: Use a soft cloth to wipe gently the water droplet or the oil from the dome cover. Then, use an oil-free cotton cloth or paper soaked with alcohol or detergent to clean the lens from the center of the dome to outside. Change the cloth several times to ensure the dome cover is clean.



WARNING

- Modify the default password after login.
- Use attachments and accessories only specified by the manufacturer. Any change or modification of the equipment, not expressly approved by Dahua, could void the warranty.
- Internal and external ground connection should be stable.
- Do not supply power via the Ethernet connection (PoE) when power is already supplied via the power connector.
- Disconnect power before device maintenance and overhaul. It is prohibited to open the cover with power on in an explosive environment.
- Please contact the local dealer or the nearest service center if the device fails to work normally, please don't dismantle or modify the device.

Cybersecurity Recommendations

Mandatory actions to be taken towards cybersecurity

- **Change Passwords and Use Strong Passwords**
 - The number one reason systems get “hacked” is due to having weak or default passwords. It is recommended to change default passwords immediately and choose a strong password whenever possible. A strong password should be made up of at least 8 characters and a combination of special characters, numbers, and upper and lower case letters.
- **Update Firmware**
 - As is standard procedure in the tech-industry, we recommend keeping NVR, DVR, and IP camera firmware up-to-date to ensure the system is current with the latest security patches and fixes.

Recommendations to improve your network security

- **Change Passwords Regularly**
 - The length should be greater than 8 characters;
 - Include at least two types of characters; character types include upper and lower case letters, numbers, and symbols;
 - Do not use an account name or the account name in reverse order;
 - Do not use sequential characters, such as 123, abc, etc.;
 - Do not use repeated characters, such as 111, aaa, etc.;
- **Change Default HTTP and TCP Ports**
 - Change default HTTP and TCP ports for systems. These are the two ports used to communicate and to view video feeds remotely.
 - These ports can be changed to any set of numbers between 1025 and 65535. Avoiding the default ports reduces the risk of outsiders being able to guess which ports you are using.
- **Update Firmware and Client Software**
 - Keep your network-enabled equipment (such as NVRs, DVRs, IP cameras, etc.) firmware up-to-date to ensure the system is equipped with the latest security patches and fixes. When the equipment is connected to the public network, it is recommended to enable the “auto-check for updates” function to obtain timely information of firmware updates released by the manufacturer.
 - Download and use the latest version of client software.
- **Enable HTTPS/SSL**
 - Set up an SSL Certificate and enable HTTPS to encrypt all communication between your devices and recorder.
- **Enable IP Filter**
 - Enable the IP filter to prevent unauthorized access to the system.

- **Change ONVIF Password**
 - Older IP camera firmware does not automatically change the ONVIF password when the system credentials are changed. Update the camera's firmware to the latest revision or manually change the ONVIF password.
- **Forward Only Ports You Need**
 - Forward only the HTTP and TCP ports that are required. Do not forward a wide range of numbers to the device. Do not DMZ the device's IP address.
 - Do not forward any ports for individual cameras if they are all connected to a recorder on site. Simply forward the NVR port.
- **Disable Auto-Login on SmartPSS**
 - Disable the Auto-Login feature on SmartPSS installed on a computer that is used by multiple people. Disabling auto-login prevents users without the appropriate credentials from accessing the system.
- **Use a Different Username and Password for SmartPSS**
 - Do not use a username/password combination that you have in use for other accounts, including social media, bank account, or email in case the account is compromised. Use a different username and password for your security system to make it difficult for an unauthorized user to gain access to the IP system.
- **Limit Features of Guest Accounts**
 - Ensure that each user has rights to features and functions they need to perform their job.
- **Disable Unnecessary Services and Choose Secure Modes**
 - Turn off specific services, such as SNMP, SMTP, and UPnP, to reduce network compromise from unused services.
 - It is recommended to use safe modes, including but not limited to the following services:
 - SNMP: Choose SNMP v3 and set up strong encryption passwords and authentication passwords.
 - SMTP: Choose TLS to access a mailbox server.
 - FTP: Choose SFTP and use strong passwords.
 - AP hotspot: Choose WPA2-PSK encryption mode and use strong passwords.
- **Multicast**
 - Multicast is used to share video streams between two recorders. Currently there are no known issues involving Multicast. Deactivate this feature if not in use to enhance network security.
- **Check the Log**
 - The information stored in the network log file is limited due to the equipment's limited storage capacity. Enable the network log function to ensure that the critical logs are synchronized to the network log server if saving log files is required.
 - Check the system log if you suspect that someone has gained unauthorized access to the system. The system log shows the IP addresses used to login to the system and the devices accessed.
- **Physically Lock Down the Device**
 - Perform physical protection to equipment, especially storage devices. For example, place the equipment in a special computer room and cabinet, and implement access control permission and key management to prevent unauthorized personnel from accessing the equipment.

- **Connect IP Cameras to the PoE Ports on the Back of an NVR**
 - Cameras connected to the PoE ports on the back of an NVR are isolated from the outside world and cannot be accessed directly.
- **Isolate NVR and IP Camera Network**
 - Ensure that the network for the NVR and IP cameras should not be the same network as a public computer network. Separate networks prevent unauthorized users accessing the same network the security system.
- **Secure Auditing**
 - Check online users regularly to ensure unauthorized accounts are not logged in to a device.
 - Check the equipment log to access the IP addresses used to login to devices and their key operations.



Table of Contents

Foreword.....	I
Important Safeguards and Warnings.....	IV
Cybersecurity Recommendations	VII
Table of Contents	X
1 Overview	1
1.1 DHI-VTO2202F-P IP Outdoor Station	1
1.1.1 Front Panel.....	1
1.1.2 Rear Panel	2
1.1.3 Dimensions.....	3
1.2 DHI-VTH2421FW-P Indoor Monitor	4
1.2.1 Front Panel.....	4
1.2.2 Rear Panel	4
1.2.3 Dimensions.....	5
2 Installation and Configuration	6
2.1 Installation Tips.....	6
2.2 VTO Installation	6
2.3 Surface-mount.....	7
2.4 Flush-mount	8
2.5 Configuring Door Locks	9
2.5.1 Electric Door Lock.....	9
2.5.2 Magnetic Door Lock.....	9
2.6 Configuration	10
2.6.1 Initialize the VTH	10
2.6.2 Configure the VTH.....	12
2.6.3 Configure the VTO.....	13
2.7 Answering a Call from a VTO.....	13
2.8 Monitoring a VTO Station.....	14

WE SECURE YOUR LIFE
 ★★★★★★

1 Overview

The DHI-KTP01(S) IP Video Intercom kit is a complete solution that includes an outdoor station with wide-angle camera, a color indoor monitor, and accessories to mount and power the components. The kit allows a tenant to view and talk with visitors and remotely unlock doors all from the indoor monitor. The IP outdoor station includes a 2 MP wide angle camera with two-way talk and is suitable for most outdoor applications. The kit is powered by PoE via the included 4-port PoE Ethernet switch, making installation easier, without the need to install additional dedicated power cables.

The kit consists of the following components:

- DHI-VTO2202F-P IP Outdoor Station
- DHI-VTH2421FW-P Indoor Monitor
- DH-PFS3005-4ET-60 PoE Switch
- VTM115 Surface-mount Box for DHI-VTO2202F-P

1.1 DHI-VTO2202F-P IP Outdoor Station

1.1.1 Front Panel

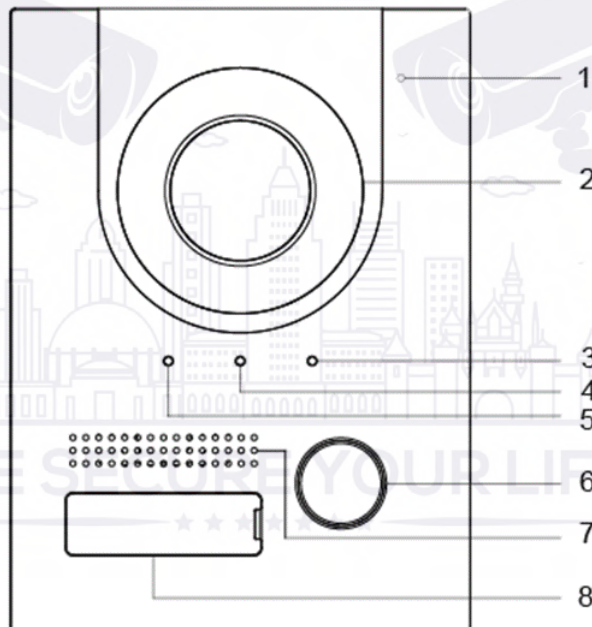

Ref.	Description	Ref	Description
1	Microphone	5	Door Unlocked Indicator
2	Camera	6	Call Button
3	Call Indicator	7	Speaker
4	Communication Indicator	8	Slot for Paper Messages

1.1.2 Rear Panel

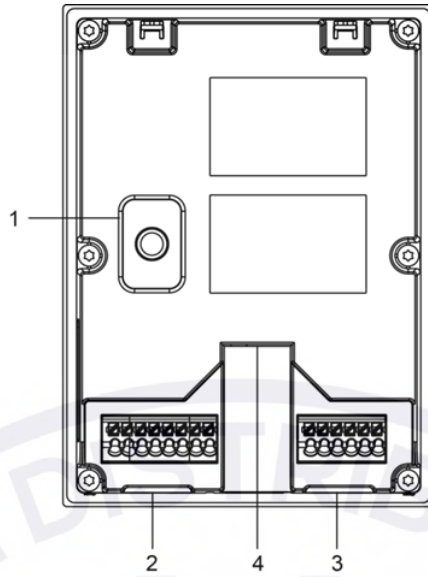

Ref.	Description
1	Tamper Switch
2	RS485_B: RS-485 communication RS485_A: RS-485 communication ALARM_NO: Switch quantity output ALARM_COM: Switch quantity output
3	DOOR_BUTTON: Unlock button DOOR_FEEDBACK: Door contact feedback GND: GROUND DOOR_NC: Connected to access controller to control door locks DOOR_COM: Connected to access controller to control door locks DOOR_NO: Connected to access controller to control door locks
4	RJ-45 Ethernet Connector



1.1.3 Dimensions

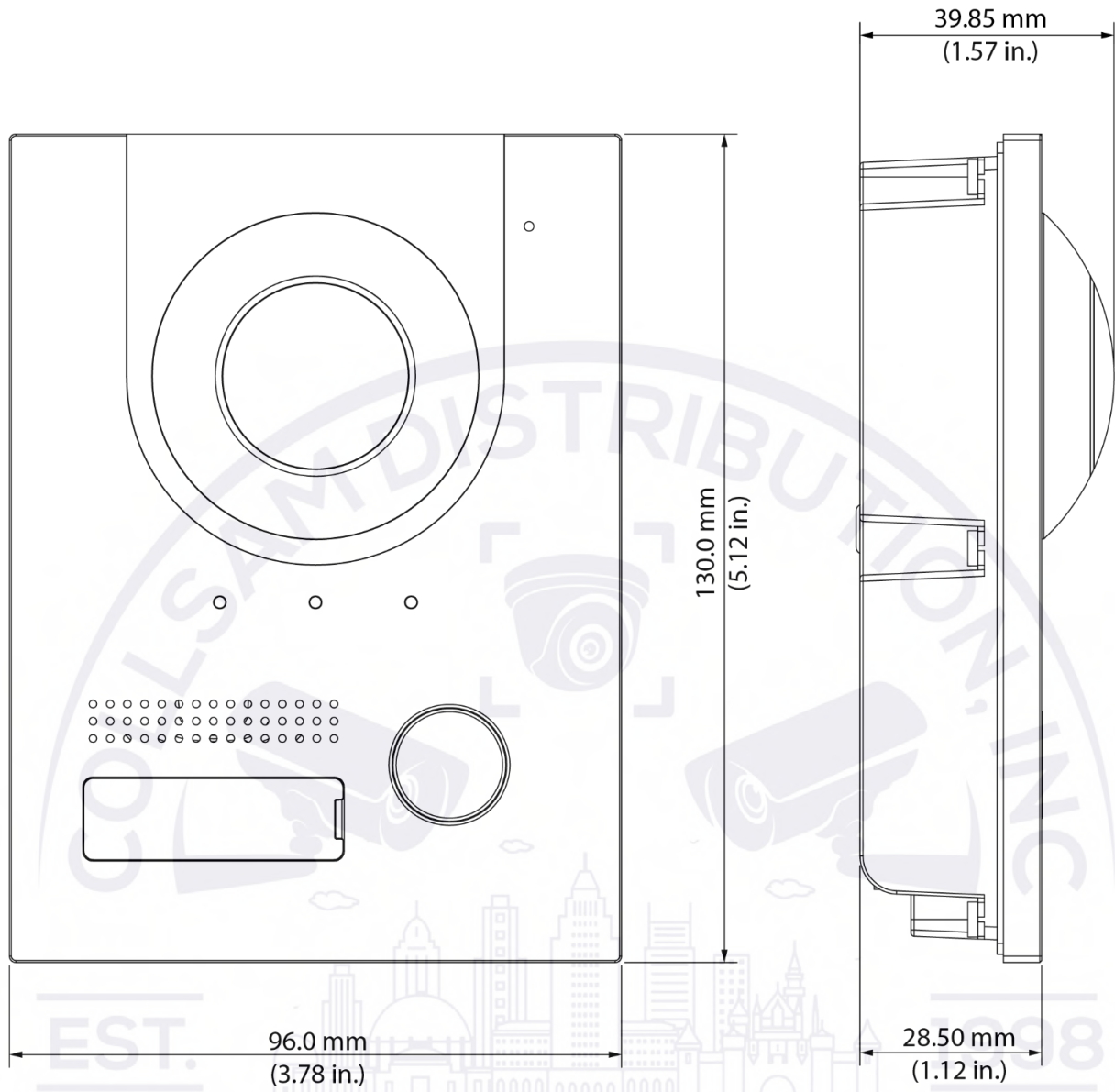

1.2 DHI-VTH2421FW-P Indoor Monitor

1.2.1 Front Panel

Icon	Name	Description
	SOS	Tap to alert the call center in case of an emergency.
	Menu	Tap to return to the main menu.
	Call	Tap to answer the call. During communication, tap to hang up. During monitoring, tap to speak to VTO outdoor station.
	Monitor	In standby mode, Tap to view video from VTO outdoor station. Tap again to exit video monitoring.
	Unlock	Tap to unlock a door controlled by the connected VTO outdoor station.
	Message Indicator	Indicated an unread message.
	Power Indicator	The indicator is green when the power supply is normal.
Network	Network Indicator	Indicates communication with the VTO outdoor station is normal. If the indicator is off the unit is experiencing a communication error with the VTO outdoor station.

1.2.2 Rear Panel

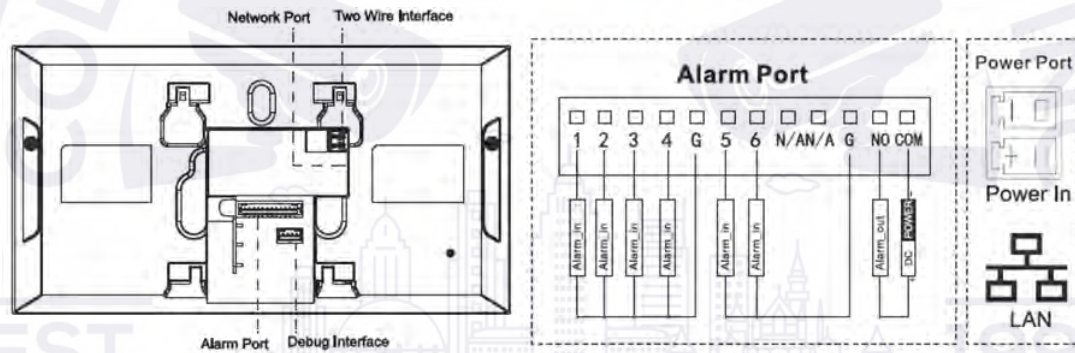

1.2.3 Dimensions

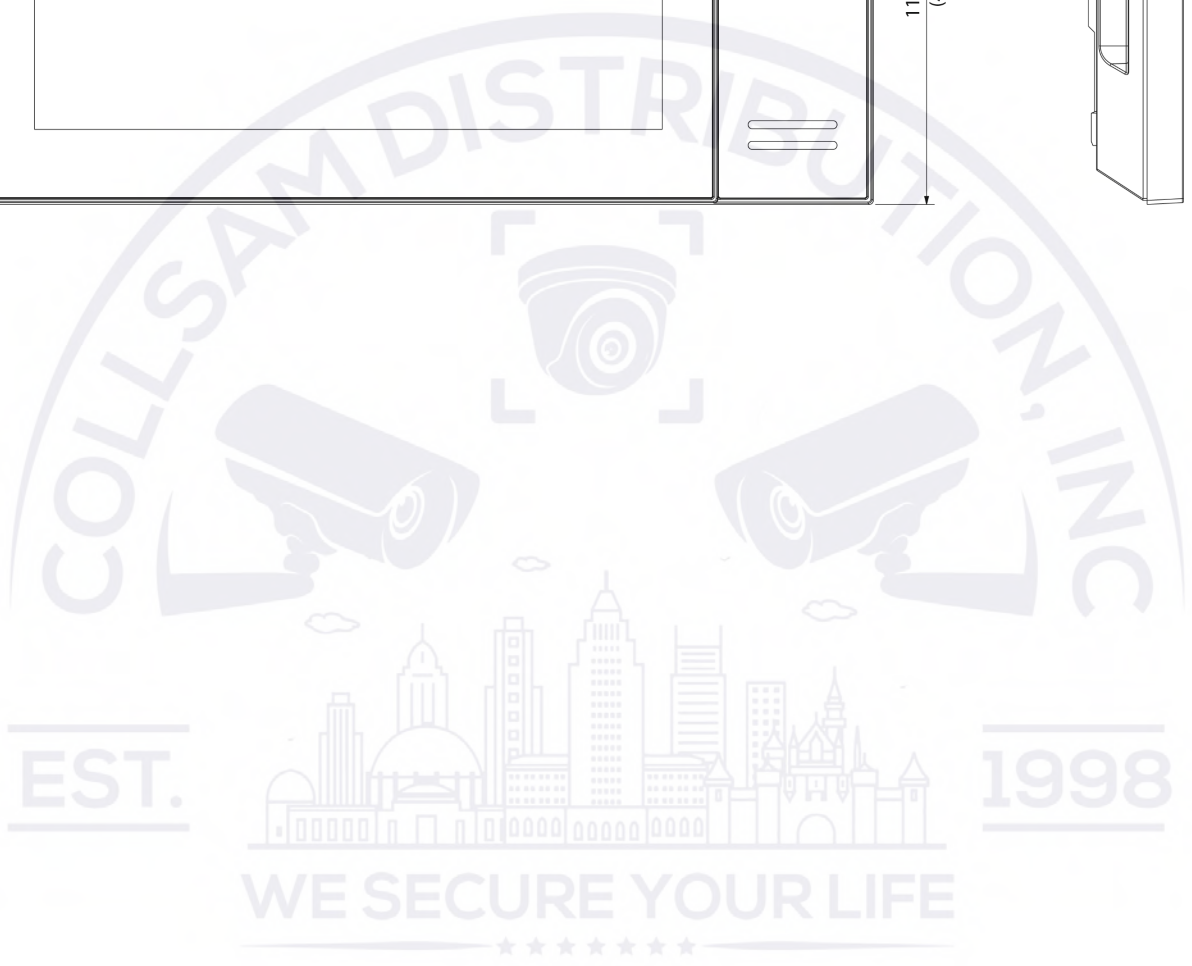
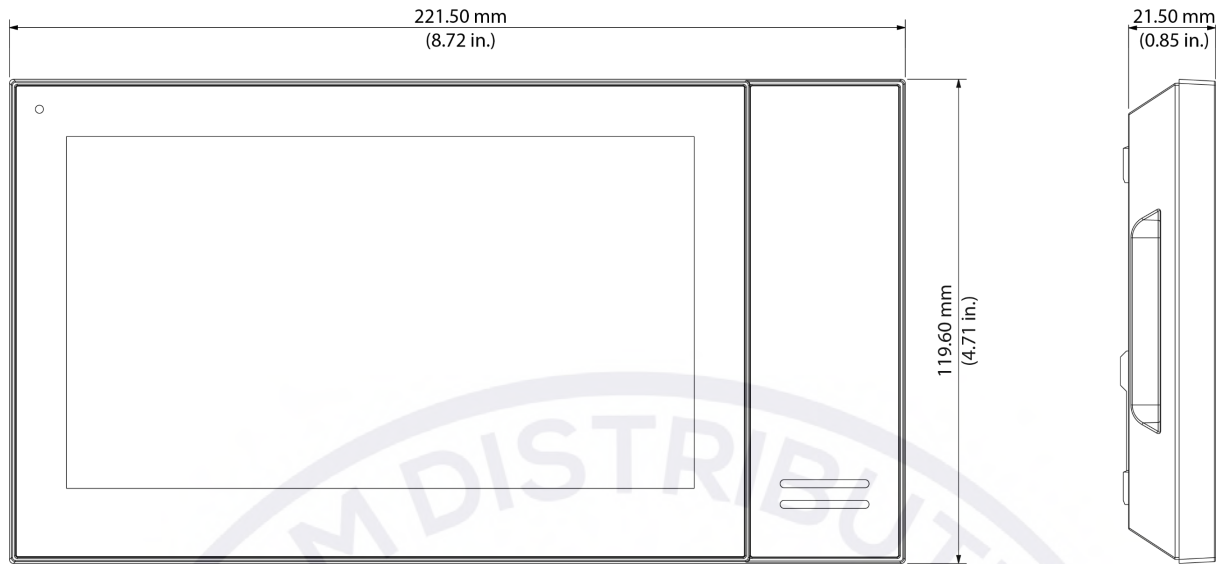

2 Installation and Configuration

The Video Intercom kit ships with all the components to mount the VTO Outdoor Station to surface of a wall. To flush-mount the VTO, order the VTM114 Flush-mount box. Before installing the camera consider the following:

- Review the “Installation Tips” section to help you choose an ideal mounting location.
- Decide whether to run the cables through the wall or along the wall.

2.1 Installation Tips

To ensure the best possible performance, it is recommended to keep the following installation tips in mind when choosing a location for each component:

- Do not install the devices in an environment exposed to condensation, high temperatures, direct sunlight, and a dusty or corrosive area.
- If any component does not properly power up, remove the PoE network cable. Power on again after troubleshooting.
- It is recommend professional CCTV professionals install and configure the components.
- Do not dismantle, remove the outer housing, or attempt repair on any component. Contact Technical Support if a component is not properly working.
- The suggested installation height of central point of the VTO device is 1.40 m to 1.60 m (55.12 in. to 63.0 in.) above the ground.
-

2.2 VTO Installation

This equipment should be unpacked and handled with care. If an item appears to have sustained damage during shipping, notify the shipper immediately.

Verify that all the parts listed below are included. If an item is missing, contact customer support or your local representative.

The original packing carton is the safest container to transport the unit, in the event the unit must be returned for service. Retain the carton and all shipping material for future use.

2.3 Surface-mount

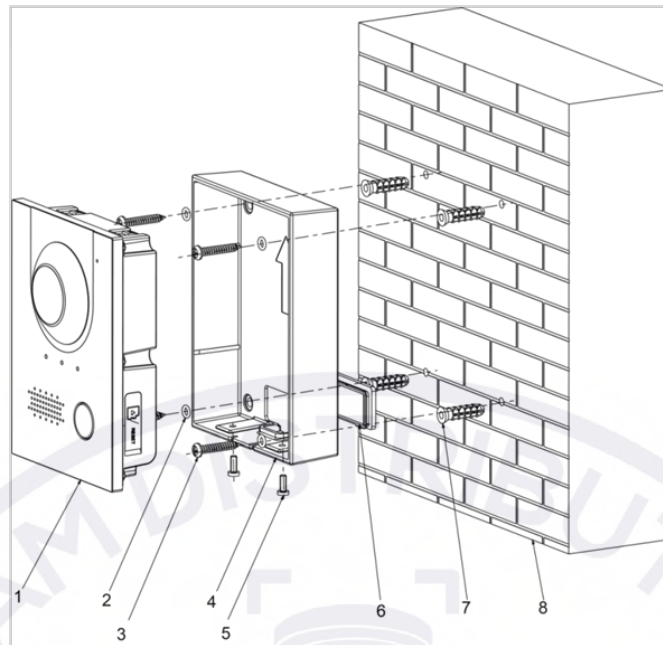

Ref.	Name	Ref.	Name
1	VTO Outdoor Station	5	M3x8 Screws
2	Waterproof O-ring	6	Waterproof Pad
3	ST4x25 Self-tapping Screw	7	Expansion Screw
4	Surface-mount Box	8	Wall

1. Use the Surface-mount box as a guide and drill four holes into the installation medium.
2. Place the four expansion screws into the pre-drilled holes.
3. Install the waterproof pad to the rear of the surface mount box.
4. Place a waterproof O-ring on each ST4x25 self-tapping screw.
5. Install the mounting box on the wall by screwing the four ST4x25 self-tapping screws into the expansion screws.
6. Place the VTO outdoor station into the surface mount box.
7. Secure the VTO outdoor station to the surface mount box by screwing the two M3x8 screws from the bottom of the surface mount box.
8. Apply silicone sealant to the gaps between the device and the wall.

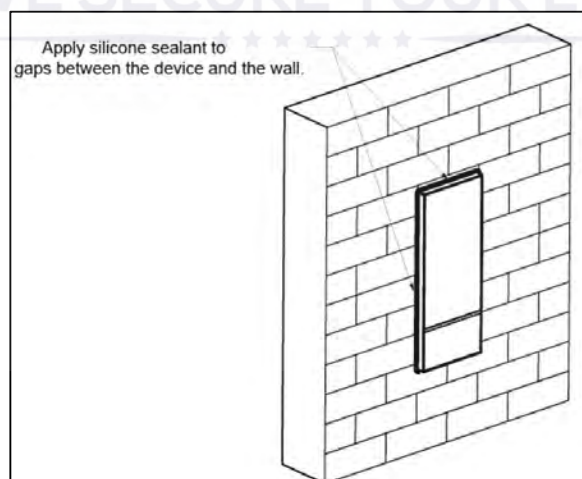

2.4 Flush-mount

You must purchase the VTM114 Flush-mount box separately. Prior to installation, ensure that you can cut a space from the installation medium to accommodate the flush-mount rear panel.

- The dimensions of the space must greater than:
113.0 mm x 149.0 mm x 35.0 mm (4.45 in. x 5.87 in. x 1.38 in.)
- But less than:
123.0 mm x 157.0 mm x 35.0 mm (4.84 in. x 6.18 in. x 1.38 mm)

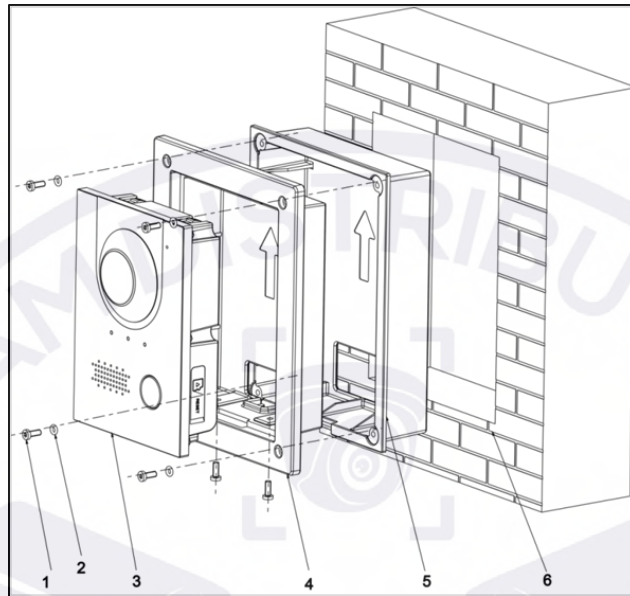

Ref.	Name
1	M3x8 Screws
2	Waterproof O-ring
3	VTO Outdoor Station
4	Front Panel
5	Rear Panel
6	Wall

1. Cut a space in the installation medium to accommodate the size of the rear panel.
2. Place the rear box into the wall. Ensure the arrow points up.
3. Place the VTO outdoor station into the front panel.
4. Secure the VTO outdoor station to the surface mount box by screwing the two M3x8 screws from the bottom of the flush-mount front panel.
5. Place the front panel with the VTO into the rear panel.
6. Place a waterproof O-ring on each M3 x 8 screw.
7. Secure the front panel to the rear panel using the four M3 x 8.
8. Apply silicone sealant to gaps between the device and the wall.

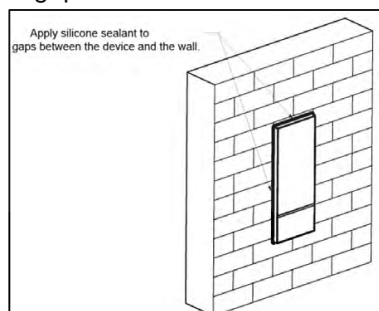

2.5 Configuring Door Locks

The VTO outdoor station supports connection to an electric or to a magnetic door lock mechanism. The VTO then can unlock the door when a tenant issues the door unlock command from the VTH indoor monitor.

2.5.1 Electric Door Lock

Connect the positive end of the electric door lock to the NO port on the rear panel of the VTO outdoor station. Connect the negative end of the electric door lock to the public end.

When connect the door station (VTO) to the on-off button, connect one end of the on-off button to one end of the on-off button of the door station (VTO), and then connect the other end of the on-off button to the GND of door station (VTO).

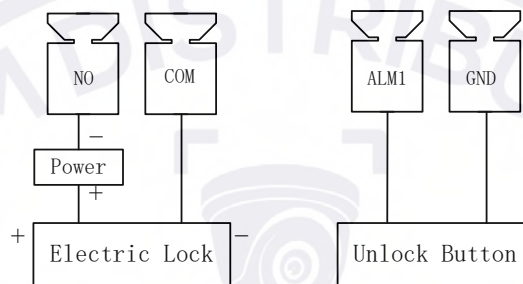

2.5.2 Magnetic Door Lock

Connect the positive end of the magnetic door lock to the NC port on the rear panel of the VTO outdoor station. Connect the negative end of the magnetic door lock to the public end.

When connect the door station (VTO) to the on-off button, connect one end of the on-off button to one end of the on-off button of the door station (VTO), and then connect the other end of the on-off button to the GND of door station (VTO).

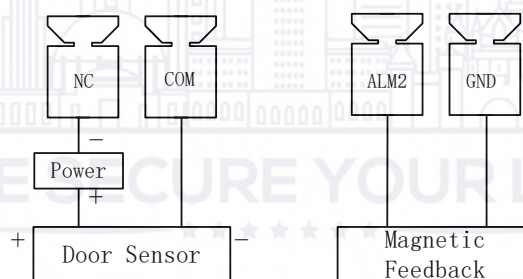

2.6 Configuration

- Before configuration, install and power up all components.
- IP addresses and No. of every door station (VTO) and indoor monitor (VTH) have been planned.
- Scan QR code on the cover for details.

2.6.1 Initialize the VTH

You must supply the following information before configuring the VTH:

- Password
- Email address (used to retrieve password)

1. Power on the device.

The system displays the Device Initialization interface.

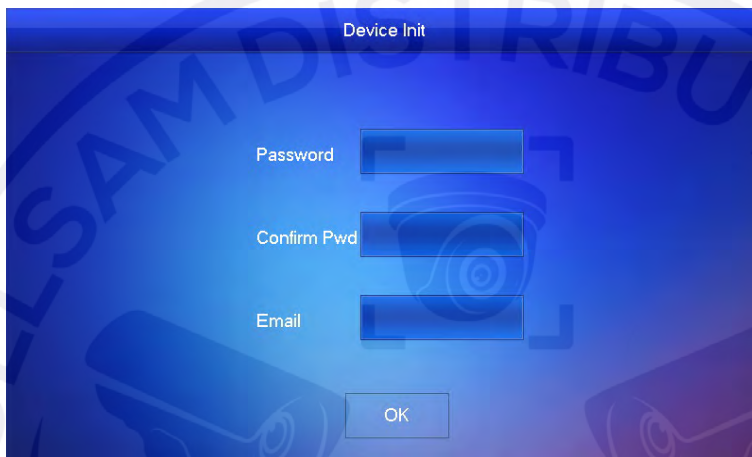

The screenshot shows a blue-themed interface titled "Device Init". It contains three input fields: "Password", "Confirm Pwd", and "Email". Below these fields is an "OK" button. The background features a faint watermark of a city skyline and the text "COLLSAM DISTRIBUTION, INC" and "EST. 1998".

2. Type your Password, and then type the same password in Confirm Pwd box.
3. Type a valid email address.
4. Press OK.

The system prompts for the Quick Configuration.

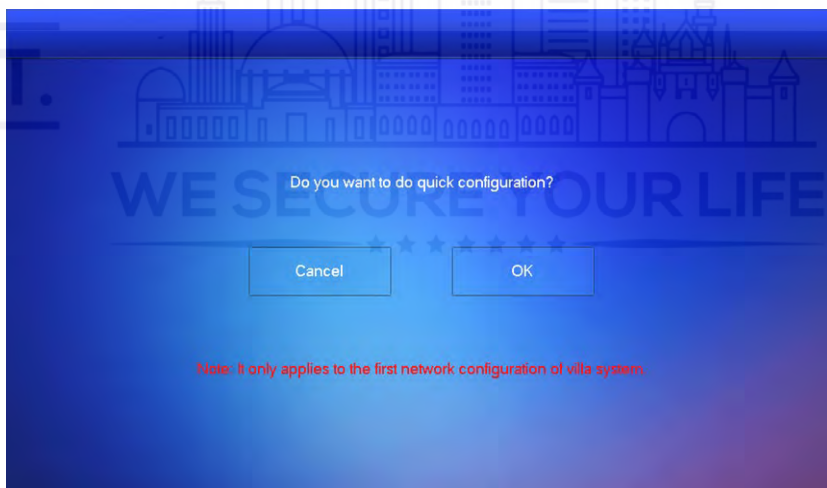

The screenshot shows a blue-themed interface with the text "Do you want to do quick configuration?". Below this text are two buttons: "Cancel" and "OK". At the bottom, there is a red note: "Note: It only applies to the first network configuration of villa system." The background features a faint watermark of a city skyline and the text "COLLSAM DISTRIBUTION, INC" and "EST. 1998".

5. Tap OK.
6. The system displays all intercoms devices on the same network.

Device Type	SN	MAC	IP	Status	Operation
VTO	4G017E1YAZ37515			Initialized	Initialize
VTO	3E04030YAZ00018			Initialized	Initialize
VTH	3c:ef:8c:0b:4d:27			Initialized	Initialize
VTH	PZZ4LN058W00004			Initialized	Initialize
VTO	ASDFGZXCVBQWERT			Uninitialized	Initialize

Navigation: 1 2 3 4 5 6, Refresh, Next, < >

7. Select an uninitialized device, in this case the VTO outdoor station that came with the kit.
8. Type the Password, then confirm the password, and enter an email address for the device.

Device Init

Password: [dots]

Confirm Pwd: [dots]

Email: 123@163.com ✓

Buttons: Cancel, OK

9. Tap OK to accept the credentials and to return to the Device page.

2.6.2 Configure the VTH

1. Tap Edit to configure the VTH device.

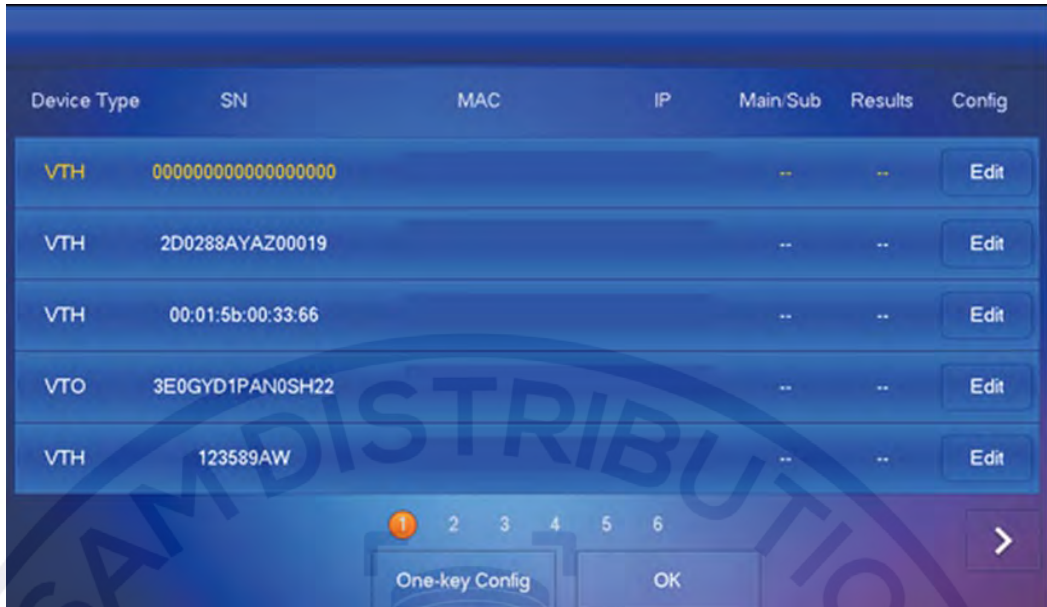

2. Tap the MAIN button to indicate the VTH is the main monitor.
3. Supply the Local IP Address, Subnet Mask, and the Gateway.

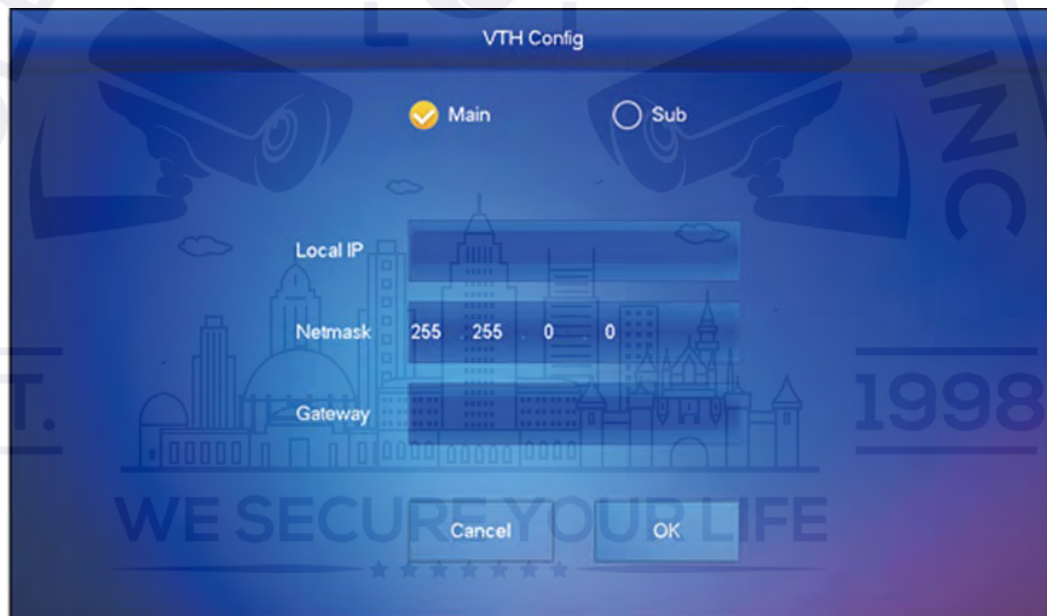

4. Tap OK to complete the VTH configuration.

2.6.3 Configure the VTO

1. Select the VTO outdoor station from the device list.



2. Tap the MAIN button to indicate the VTO is the primary outdoor station.
3. Enter the Local IP Address, Subnet Mask, and the Gateway address for the VTO.
4. Tap the NTSC video standard.
5. Select the date and time formats.
6. Set the current date and time.
7. Tap OK.

2.7 Answering a Call from a VTO

To verify that a VTH unit is configured properly, make a test call from a VTO unit.

- Dial the VTH room number from the VTO unit.

The VTH unit displays the video feed and the operating keys from the VTO if all settings are configured properly.

Note in the image below that the Snapshot and Record keys are active. These active functions indicate that the VTH has an SD card inserted in the unit.

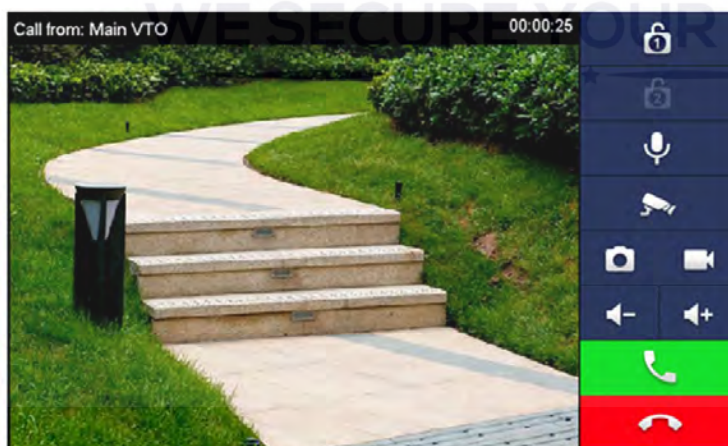

2.8 Monitoring a VTO Station

- Select Monitor > Door, and then select the VTO you wish to monitor. Press the Star icon to add this VTO to the Favorite List.

